

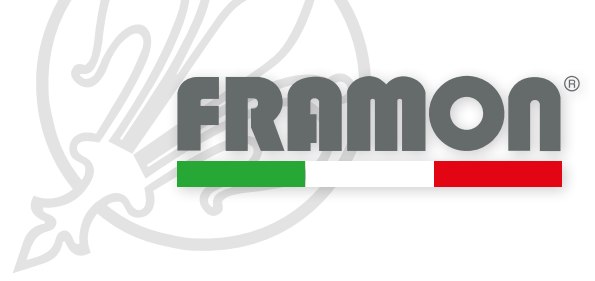

FRAMON[®]
COMPONENTS DIVISION

**OTTONE COMPONENTI
PER INTERNO**
INDOOR BRASS COMPONENTS



MADE IN ITALY

L'intero ciclo produttivo dei nostri componenti è totalmente realizzato in Italia. Gli articoli vengono sottoposti a controlli accurati e per la maggior parte timbrati a gravità pressofusa con la certificazione "Made in Italy", sinonimo di autenticità e qualità certificata e garantita nel tempo.

The entire production cycle of our components is done completely in Italy. The items are submitted to accurate controls and the most are signed with gravity die casting with the certification "Made in Italy", synonym of authenticity and certified and guaranteed over the time quality.

A close-up photograph of a metal surface, likely a component, showing the words "MADE IN ITALY" stamped in large, raised, block letters. The metal has a slightly textured, golden-brown appearance.



Le nostre radici, la nostra forza

Framon Components è il frutto di una storia quasi centenaria: affonda le sue radici nell'azienda fondata da Antonio Montini nel 1930 a Lumezzane, trasformata poi negli anni settanta dai figli del fondatore in Framon S.p.A. e nel tempo ulteriormente sviluppatasi grazie ad acquisizioni di marchi prestigiosi, fino a presentarsi oggi come Framon Group, leader europeo nella realizzazione di prodotti e componenti nel settore dell'illuminazione. Framon Components è quindi uno dei marchi aziendali da cui è costituito il gruppo Framon, dal quale eredita i valori di una qualità e di uno stile produttivi consolidati nel tempo.

La Nostra Missione, Il Nostro Impegno

Framon Components nasce come azienda interamente dedicata alla produzione di componenti in fusione per l'illuminazione, con l'obiettivo di contribuire a razionalizzare la presenza di Framon Group sul mercato nazionale e internazionale e di offrire così ulteriori vantaggi alla clientela.

La nostra missione è la prosecuzione di un lavoro che oggi s'intende incrementare grazie alla competenza acquisita in decenni di impegno professionale altamente qualificato, all'impiego di livelli tecnologici e di informatizzazione sempre più elevati, alla capillare rete vendita internazionale di cui possiamo avvalerci all'interno del gruppo Framon.



Tradizione e qualità del made in italy

Framon Components si sviluppa quindi all'interno della tradizione manifatturiera italiana, rinnovando quotidianamente l'esperienza di quel Made in Italy che è sinonimo di eccellenza: tutte le fasi di lavorazione dei prodotti, dallo stampaggio dei semilavorati, alla preparazione per la verniciatura, all'eventuale verniciatura vera e propria in polveri epossidiche; dall'immagazzinamento allo stoccaggio, sono svolte all'interno delle nostre unità produttive e rispondono ai più elevati standard qualitativi secondo i principi del Total Quality Management.

Prodotti e progetti per indoor & outdoor

Framon Components produce una vastissima gamma di componenti nel settore illuminazione per esterni e per interni, residenziale e urbana, realizzati esclusivamente con l'utilizzo di materie prime di alta qualità, con una selezione accuratissima di materiali eco-compatibili e una spiccata attenzione alle esigenze ecologiche contemporanee. Oltre ai più di 15.000 articoli e derivati già a catalogo e pronti a magazzino per il cliente, Framon Components è in grado di sviluppare e produrre nuovi articoli su specifiche necessità e richieste, partendo da eventuali prototipi, creando progetti e stampi per la realizzazione del prodotto finito.

Fondere, trasformare, creare

Framon Components si avvale di alcune tra le più importanti tecnologie di trasformazione della materia prima: dalla pressofusione alla fusione in conchiglia, con o senza anima; allo stampaggio a caldo di materie prime diverse come alluminio, ottone, zama, materie plastiche. Framon Components è in grado di eseguire qualsiasi tipo di lavorazione meccanica sulle fusioni prodotte, utilizzando macchinari tecnologicamente avanzati e continuamente rinnovati, come complessi transfer, torni a controllo numerico e centri di lavoro.

Framon Components propone i propri articoli con una finitura superficiale che si ferma volutamente al primo stadio di burattatura o di sabbiatura; ma fornisce anche i componenti prodotti con la tipologia di finitura espressamente richiesta dal cliente.



Una partnership sicura e vantaggiosa

Tradizione e innovazione, qualità e competitività del prodotto, capacità imprenditoriale e affidabilità, fanno di Framon Components un partner importante per tutte le aziende operanti nel settore dell'illuminazione e dell'arredamento. Framon Components non offre solo prodotti: grazie anche alle risorse e alle competenze condivise con l'intero gruppo Framon, è in grado di offrire un servizio integrale qualificato, collaborando nello sviluppo di nuovi progetti, accompagnando il cambiamento produttivo e culturale necessario per affrontare le nuove realtà del mercato. Framon Components è quindi una moderna realtà capace di un'offerta ricca di nuovi e importanti vantaggi per la sua clientela.



Our roots, our power

Framon Components is the product of an almost thousand-years old history which has its roots in the company founded by Antonio Montini in 1930 in Lumezzane, then transformed in the Seventies by his sons in Framon S.p.A. and developed during the time thanks to the acquisition of prestigious brands, until showing today as Framon Group, European leader in the manufacturing of products and components for the lighting sector. Framon Components is then one of the company brands of the Framon group, from which inherits the values of quality and long-time established production style.

Our mission, our commitment

Framon Components is born as a company entirely dedicated to the production of lighting casting components, with the goal to contribute to rationalize the presence of Framon Group in the national and international market and offering further advantages to the customers. Our mission is going ahead with the work, which today is expected to increase thanks to the competence acquired during decades of high-qualified professional commitment, the usage of higher and higher technological and digital levels, the widespread international sales network, which we can take advantage on in the Framon group.



Tradition and quality of Made in Italy

Framon Components develops inside the Italian manufacturing tradition, renewing every day the experience of that Made in Italy which is synonym of excellence: all the products processing steps, from semifinished products casting, the preparation for the paint process, the possible real paint with epoxy powder coatings, warehousing, to storage, are done inside our production units while meeting the highest quality standards according to the principles of Total Quality Management.

Products and Projects for indoor & outdoor

Framon Components manufactures a very wide range of components in the indoor and outdoor lighting sector, residential and urban settings, using high quality raw materials and selecting eco-compatible materials and paying deep attention to the contemporary environmental requirements. With more over than 15.000 items and derivatives already in the catalogue and ready in the warehouse for the customer, Framon Components can develop and manufacture new items based on specific needs and requests, starting from possible prototypes, creating projects and moulds for the realization of the finished product.



Casting, transforming, creating

Framon Components takes advantage from some of the most important raw material transformation technologies: from die casting to shell casting, with or without core, to hot stamping of different raw materials, such as aluminium, brass, zamak, plastic materials. Framon Components can do every type of mechanical work on the casting produced, using technological innovative machinery and continually renewed, like complex transfers, numerical control lathes and machining centres.

Framon Components offers its own items with a superficial finishing which intentionally stops at the first step of tumbling or sandblasting; but supplies also the manufactured components with the finishing requested by the customer.

A convenient and safe partnership

Tradition and innovation, quality and competitiveness of the product, entrepreneurial ability and reliability make Framon Components an important partner for all the companies in the lighting and furniture sector. Framon Components does not offer just products: thanks to the resources and the competences shared with the entire Framon group, it can offer a complete and qualified service, cooperating in the development of new products, accompanying the manufacturing and cultural change necessary to face the new realities of the market. Framon Components, then, is a modern reality which offers new and important advantages for its customers.



Ganci **Hooks** **15**

Catene **Chains** **25**



Rosoni **Canopies** **29**



Colonne **Columns** **39**

Colonne Componibili **Composable Columns** **61**



Distanziali **Spacers** **81**

Sfere **Spheres** **109**

Finali **Finials** **113**



Copricentri **Cover Bodies** **125**

Anelli **Rings** **143**





Padelline **Bobeches** **153**

Portacandele **Candle holder** **175**



Bracci Scanalati	Grooved Arms	185	
Bracci con Filo Esterno	Arms with External Cable	207	
Bracci Componibili	Composable Arms	219	
Bracci con Tubo Interno	Arms with Internal Tube	231	
Bracci e Riccioli portatubo	Tube holder Arms & Curls	291	

Fregi e Riccioli	Frieze Ornaments & Curls	309	
Lanterne	Lanterns	335	

Basi	Bases	365	
-------------	--------------	------------	---

Appliques	Wall Brackets	439	
Plafoniere	Ceiling Lamps	481	
Faretti da Incasso	Recessed Spotlight	493	

ARTICOLI VARI / VARIOUS ITEMS

Portalumi	Lamps holder	499	
Alogene	Halogen Lights	501	
Cornici	Frames	505	
Putti	Cherubs	509	
Ornamenti	Decorative Items	513	
Capitelli	Capitals	527	



OTTONE BRASS

Alogene	p. 501	Arms with External Cable	p. 207
Anelli	p. 143	Arms with Internal Tube	p. 231
Appliques	p. 439	Bases	p. 365
Basi	p. 365	Bobeches	p. 153
Bracci Componibili	p. 219	Candle holder	p. 175
Bracci con Filo Esterno	p. 207	Canopies	p. 29
Bracci con Tubo Interno	p. 231	Capitals	p. 527
Bracci Portatubo	p. 291	Ceiling Lamps	p. 481
Bracci Scanalati	p. 185	Chains	p. 25
Capitelli	p. 527	Columns	p. 39
Catene	p. 25	Composable Arms	p. 219
Colonne	p. 39	Composable Columns	p. 61
Colonne Componibili	p. 61	Cover Bodies	p. 125
Copricentri	p. 125	Curls	p. 309
Cornici	p. 505	Decorative Items	p. 513
Distanziali	p. 81	Finials	p. 113
Faretti da Incasso	p. 493	Frames	p. 505
Finali	p. 113	Grooved Arms	p. 185
Fregi	p. 309	Halogen Lights	p. 501
Ganci	p. 15	Hooks	p. 15
Lanterne	p. 335	Lamps holder	p. 499
Ornamenti	p. 513	Lanterns	p. 335
Padelline	p. 153	Frieze Ornaments	p. 309
Plafoniere	p. 481	Cherubs	p. 509
Portacandele	p. 175	Recessed Spotlight	p. 493
Portalumi	p. 499	Rings	p. 143
Putti	p. 509	Spacers	p. 81
Riccioli	p. 309	Spheres	p. 109
Riccioli Portatubo	p. 291	Tube holder Arms	p. 291
Rosoni	p. 29	Tube holder Curls	p. 291
Sfere	p. 109	Wall Brackets	p. 439

Ganci	15	10-020	18	10-038-01	21	B016-01	18	Catene	25
		10-020-01	18	10-039	18	B017	19		
10-001	18	10-022	19	10-039-01	18	B017-01	19	12-001	25
10-001-01	18	10-022-01	19	10-039-11	18	B017-02	19	12-002	25
10-001-02	18	10-022-02	19	10-041	18	B017-03	19	12-003	25
10-001-03	18	10-022-03	19	10-041-01	18	B019	21	12-004	25
10-001-07	18	10-023	19	10-043	17	B019-01	21	12-005	25
10-001-08	18	10-023-01	19	10-043-01	17	B021	21	12-006	25
10-002	17	10-023-02	19	10-043-02	17	B021-01	21	12-007	26
10-002-01	17	10-023-03	19	10-043-03	17	B021-02	21	12-008	26
10-003	16	10-024	19	10-043-13	17	B021-03	21	12-009	25
10-003-01	16	10-024-01	19	10-044	15	B025	21	12-010	26
10-003-04	16	10-024-02	19	10-047	17	B025-01	21	12-011	26
10-004	16	10-024-03	19	10-048	17	B025-02	21	12-012	26
10-004-01	16	10-025	22	10-049	23	B025-03	21	12-013	26
10-004-02	16	10-025-01	22	10-049-01	23	B034	22	12-018	27
10-004-03	16	10-025-02	22	10-049-02	23	B034-01	22	12-019	27
10-004-04	16	10-025-03	22	10-049-03	23	B034-02	22	12-020	27
10-004-05	16	10-026	19	10-050	17	B034-03	22	12-021	27
10-004-06	16	10-026-01	19	10-050-01	17	B035	22	12-023	27
10-005	15	10-026-02	19	10-050-02	17	B035-01	22	12-024	25
10-005-01	15	10-026-03	19	10-050-03	17	B035-02	22	12-025	25
10-005-02	15	10-027	19	10-050-13	17	B041	22	12-026	25
10-005-03	15	10-027-01	19	10-051	15	B041-01	22	12-027	25
10-005-04	15	10-027-02	19	10-051-01	15	B041-02	22	12-028	25
10-005-05	15	10-027-03	19	10-051-02	15	B041-03	22	12-029	25
10-005-06	15	10-028	17	10-051-03	15	B042	21	12-030	26
10-006	15	10-028-01	17	10-052	15	B042-01	21	12-031	26
10-006-01	15	10-028-02	17	10-052-01	15	B042-02	21	12-032	25
10-006-04	15	10-028-03	17	10-052-04	15	B042-03	21	12-033	26
10-007	16	10-028-04	17	10-052-10	15	B046	21	12-035	25
10-008	17	10-028-05	17	10-053	15	B046-01	21	12-036	26
10-009	17	10-028-06	17	10-053-01	15	B046-02	21	12-037	26
10-010	18	10-028-09	17	10-053-02	15	B046-03	21	C002	26
10-010-01	18	10-029	17	10-053-03	15	B054	22	C005	26
10-010-04	18	10-029-01	17	10-054	16	B054-01	22	C006	26
10-011	18	10-029-02	17	10-054-01	16	B055	19	C008	26
10-011-01	18	10-029-03	17	10-054-02	16	B055-01	19	C042	25
10-011-04	18	10-031	23	10-054-03	16	B056	21	C045	26
10-013	16	10-031-01	23	B002	16	B056-01	21	C048	27
10-013-01	16	10-031-02	23	B002-01	16	B058	16	C052	26
10-014	15	10-031-03	23	B004	16	B058-01	16	C056	26
10-014-01	15	10-032	19	B004-01	16	B061	22	P010	27
10-014-02	15	10-032-01	19	B004-02	16	B061-01	22	P027	27
10-014-03	15	10-032-02	19	B004-03	16	B062	21	V108	27
10-015	16	10-032-03	19	B004-04	16	B062-01	21	V110	27
10-015-01	16	10-033	21	B004-05	16	B066	19	V114	27
10-016	15	10-033-01	21	B004-06	16	B066-01	19		
10-016-01	15	10-034	18	B005	18	B066-02	19		
10-018	15	10-034-01	18	B005-01	18	B066-03	19		
10-018-01	15	10-035	23	B007	23				
10-018-04	15	10-035-01	23	B007-01	23				
10-018-10	15	10-038	21	B016	18				

GANCI E CATENE HOOKS & CHAINS

Ganci
Hooks

p.15

Catene
Chains

p.25



GANCI HOOKS

Lettura misure:
Measurement legenda:

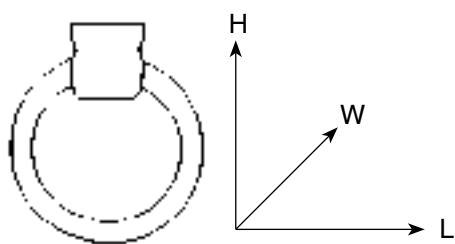

L= Lunghezza/Length
H= Altezza/Height
W= Larghezza/Width

Esempio Codice-Filetti / Code-threads Example

10-006	=	M10/1
10-006-01	=	1/8 IPS
10-006-02	=	M13/1
10-006-03	=	1/4 GAS
10-006-04	=	M 10/1 + M 4
10-006-05	=	M 13/1 + M 4
10-006-06	=	1/4 GAS + M 4
10-006-07	=	M10/1 + M 13/1
10-006-08	=	1/4 GAS + M10/1
10-006-09	=	M 10/1 + M 4 + M 6
10-006-10	=	M 10/1 + M 4 foro chiuso/closed hole
10-006-13	=	1/4 IPS



10-006
L20 x H32

filetti/threads
-01, -04



10-005
L28 x H48

filetti/threads
-01, -02, -03, -04, -05, -06



10-053
L40 x H62

filetti/threads
-01, -02, -03



10-016
L45 x H54

filetti/threads
-01



10-014
L54 x H60

filetti/threads
-01, -02, -03



10-051
L56 x H63

filetti/threads
-01, -02, -03



10-044
Ø33 x H6
filetto interno/internal thread
M 25x1,5



10-052
L39 x H41

filetti/threads
-01, -04, -10



10-018
L40 x H45

filetti/threads
-01, -04, -10



10-003

L22 x H27

filetti/threads
-01, -04



10-004

L25 x H36

filetti/threads
-01, -02, -03, -04, -05, -06



10-007

L23 x H32



B058

L28 x H35

filetti/threads
-01



B004

L27 x H35

filetti/threads
-01, -02, -03, -04, -05, -06



B002

L22 x H27

filetti/threads
-01



10-015

L48 x H60

filetti/threads
-01



10-013

L70 x H80

filetti/threads
-01



10-054

L85 x H115

filetti/threads
-01, -02, -03



10-002
L35 x H32

filetti/threads
-01



10-028
L55 x H75

filetti/threads
-01, -02, -03, -04, -05, -06, -09



10-029
L65 x H84

filetti/threads
-01, -02, -03



10-050
L25 x H60
filetto esterno/external thread
M 25x1,5

filetti/threads
-01, -02, -03, -13



10-008
L32 x H40
filetto/thread M 13/1



10-009
L32 x H34
filetto interno/internal thread
M 10/1



10-043
L25 x H47
filetto esterno/external thread
M 25x1,5

filetti/threads
-01, -02, -03, -13



10-047
L33 x H40
filetto/thread M 13/1



10-048
L33 x H42
filetto interno/internal thread
M 10/1



10-001
L17 x H19

filetti/threads
-01, -02, -03, -07, -08



B005
L30 x H38

filetti/threads
-01



10-041
L30 x H38

filetti/threads
-01



10-010
L42 x H32

filetti/threads
-01, -04



10-011
L42 x H34

filetti/threads
-01, -04



10-034
L52 x H60

filetti/threads
-01



B016
L42 x H73

filetti/threads
-01



10-020
L75 x H74

filetti/threads
-01



10-039
L48 x H60

filetti/threads
-01



10-024
L85 x H53

filetti/threads
-01, -02, -03



10-023
L110 x H63

filetti/threads
-01, -02, -03



B055
L48 x H63

filetti/threads
-01



10-027
L80 x H46

filetti/threads
-01, -02, -03



B066
L98 x H60

filetti/threads
-01, -02, -03



B017
L55 x H67

filetti/threads
-01, -02, -03



10-026
L80 x H62

filetti/threads
-01, -02, -03



10-022
L104 x H65

filetti/threads
-01, -02, -03



10-032
L60 x H78

filetti/threads
-01, -02, -03





B025
L92 x H62

filetti/threads
-01, -02, -03



B042
L51 x H53

filetti/threads
-01, -02, -03



B062
L58 x H66

filetti/threads
-01



B019
L54 x H78

filetti/threads
-01



B021
L62 x H73

filetti/threads
-01, -02, -03



B046
L50 x H75

filetti/threads
-01, -02, -03



B056
L70 x H50

filetti/threads
-01



10-038
L52 x H70

filetti/threads
-01



10-033
L65 x H80

filetti/threads
-01



B054
L52 x H80

filetti/threads
-01

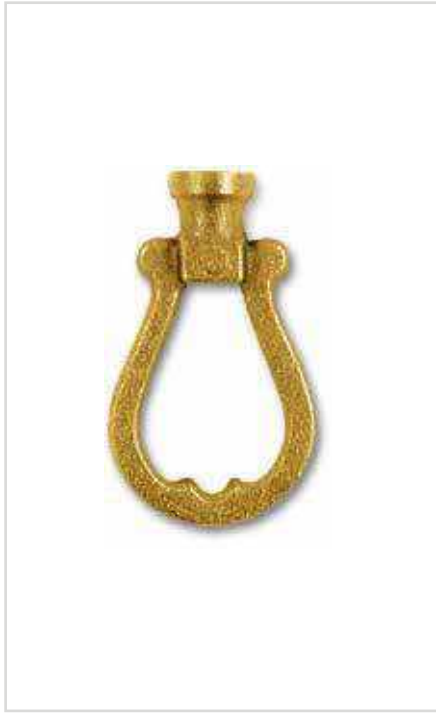

B061
L43 x H74

filetti/threads
-01



10-025
L80 x H96

filetti/threads
-01, -02, -03



B034
L72 x H88

filetti/threads
-01, -02, -03



B035
L80 x H105

filetti/threads
-01, -02



B041
L80 x H120

filetti/threads
-01, -02, -03



B007
L35 x H45

filetti/threads
-01



10-035
L43 x H50

filetti/threads
-01



10-031
L72 x H95

filetti/threads
-01, -02, -03



10-049
L95 x H125

filetti/threads
-01, -02, -03



CATENE CHAINS

Lettura misure:
Measurement legenda:

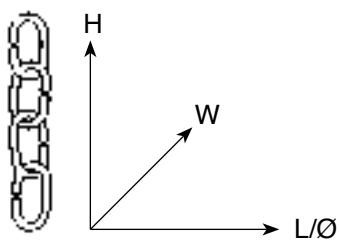

L= Lunghezza/*Length*
H= Altezza/*Height*
W= Larghezza/*Width*
Ø= Diametro/*Diameter*



12-024
L26 x H40

12-025
L35 x H56

12-026
L39 x H68

12-001
Ø3 x W26 x H500

12-002
Ø4 x W35 x H500

12-003
Ø5 x W38 x H500



12-027
L44 x H71

12-004
Ø5 x W44 x H500



12-028
L22 x H45

12-005
Ø3 x W22 x H500



12-029
L36 x H52

12-006
Ø4 x W35 x H500



12-032
L21 x H45

12-009
Ø3 x W25 x H500



12-035
L33 x H60

C042
Ø4 x W65 x H500



12-030
L21 x H44

12-031
L27 x H53

12-007
Ø3 x W22 x H500

12-008
Ø4 x W28 x H500



12-037
L60 x H90

C052
Ø7 x W57 x H500



12-033
L50 x H105

12-013
Ø5 x W50 x H500



12-036
L50 x H62

C045
Ø4 x W70 x H500



C008
Ø2 x W10 x H500

12-010
Ø3 x W16 x H500

12-011
Ø4 x W21 x H500

12-012
Ø5 x W23 x H500

C056
Ø7 x W34 x H500



C002
Ø3 x W18 x H500

C005
Ø4 x W20 x H500

C006
Ø5 x W23 x H500



12-019
L34 x H245



12-021
L18 x H220



12-023
L25 x H225



12-020
L15 x H200



P010
L25 x H235



P027
L30 x H200



C048
L29 x H100



V114
L50 x H120



12-018
L60 x H55



V110
L75 x H50

V108
L105 x H70

Rosoni	31
11-001	31
11-002	31
11-003	31
11-004	31
11-005	32
11-006	32
11-007	35
11-008	35
11-009	33
11-010	32

11-012	35
11-013	33
11-015	33
11-016	33
11-017	33
11-018	33
11-019	35
11-020	35
11-021	34
11-022	31
11-023	33
A021	34

A024	35
A025	34
A029	34
A030	31
A034	35
A037	31
A038	32
A048	34
A049	34
A050	35
A051	35
A052	32

A053	32
A054	33
A056	34
G244	35
12-023	27
12-024	25
12-025	25
12-026	25

ROSONI CANOPIES

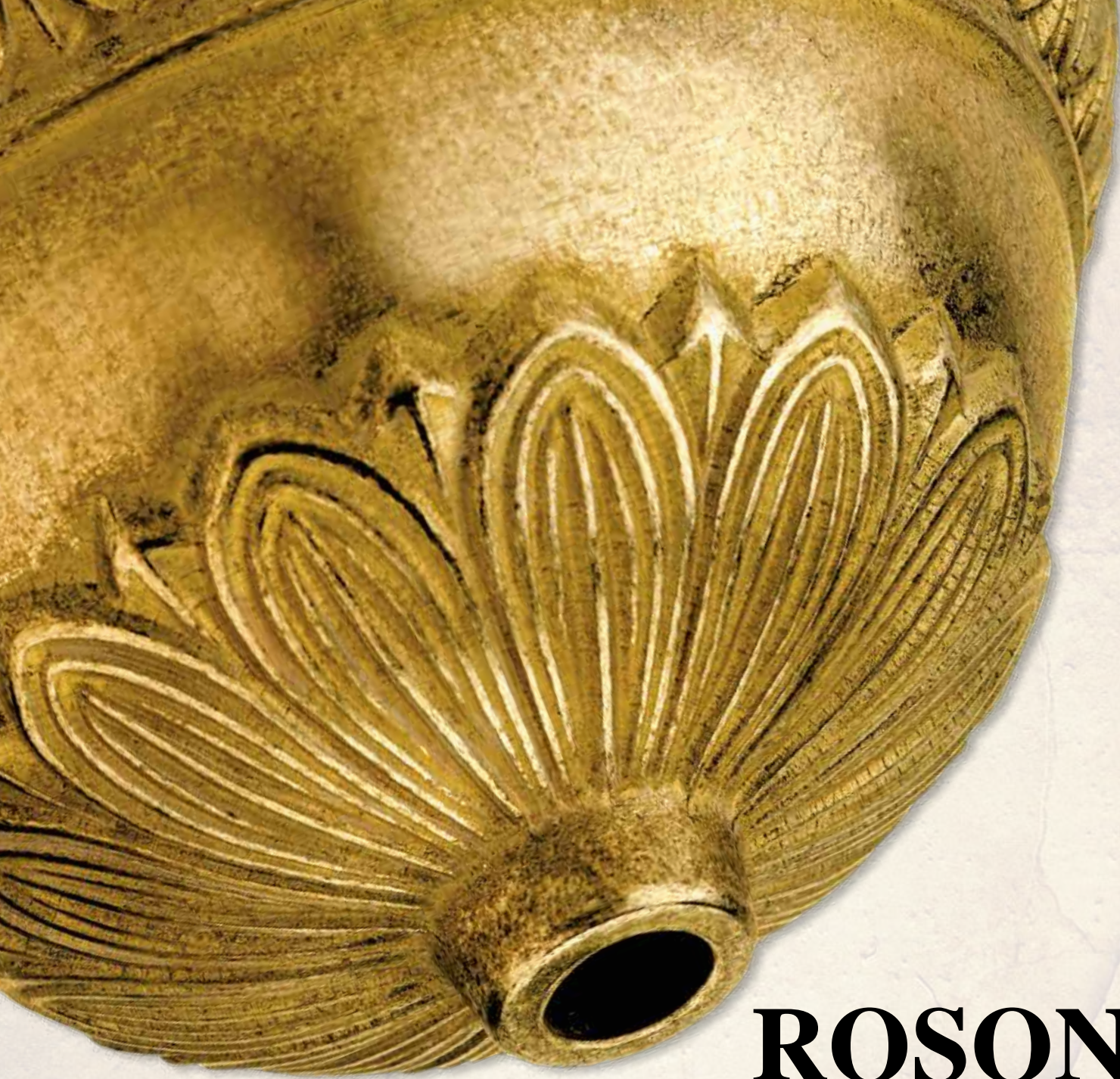

ROSONI CANOPIES

Lettura misure:
Measurement legenda:

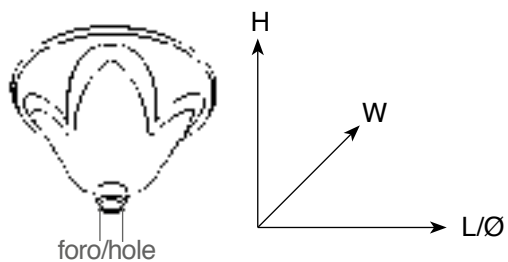

L= Lunghezza/Length
H= Altezza/Height
W= Larghezza/Width
Ø= Diametro/Diameter



A037
Ø100 x H55
foro/hole Ø11



11-004
Ø80 x H48
foro/hole Ø11

11-003
Ø110 x H68
foro/hole Ø11



11-002
Ø110 x H80
foro/hole Ø11



11-022
Ø120 x H50
foro/hole Ø11



11-001
Ø140 x H75
foro/hole Ø11



A030
Ø105 x H80
foro/hole Ø11



A038
 Ø100 x H55
 foro/hole Ø11



11-005
 Ø110 x H57
 foro/hole Ø11



A052
 Ø100 x H93
 foro/hole Ø11



11-006
 L100 x W100 x H68
 foro/hole Ø11



A053
 Ø75 x H55
 foro/hole Ø11



11-010
 Ø80 x H23
 foro/hole Ø11



11-023
Ø90 x H55
foro/hole Ø11



11-013
Ø105 x H75
foro/hole Ø11



11-016
Ø85 x H45
foro/hole Ø11



11-018
Ø80 x H52
foro/hole Ø11

11-015
Ø110 x H64
foro/hole Ø11

11-017
Ø115 x H68
foro/hole Ø11



11-009
Ø105 x H102
foro/hole Ø11



A054
Ø100 x H75
foro/hole Ø11



A049
 Ø80 x H50
 foro/hole Ø11



A029
 Ø110 x H76
 foro/hole Ø11



A056
 Ø155 x H100
 foro/hole Ø11



A025
 Ø145 x H103
 foro/hole Ø11



A021
 Ø120 x H62
 foro/hole Ø11



11-021
 Ø100 x H50
 foro/hole Ø11



A051
Ø110 x H46
foro/hole Ø11



11-008
Ø120 x H72
foro/hole Ø11

A050
Ø128 x H57
foro/hole Ø11

11-007
Ø140 x H82
foro/hole Ø11



A034
L110 x W110 x H55
foro/hole Ø11



11-012
L160 x W160 x H22
foro/hole Ø11

11-020
L120 x W120 x H55
6 petali/6 petals
foro/hole Ø11

11-019
L170 x W170 x H60
6 petali/6 petals
foro/hole Ø11



A024
L220 x W220 x H50
foro/hole Ø11

G244
L120 x W120 x H28
foro/hole Ø11

Colonne	39	E100	42	E329	54	14-042	61
		E101	39	E330	54	14-050	77
13-001	44	E103	42	E331	54	14-051	77
13-002	44	E105	42	E333	50	14-057	67
13-003	44	E106	42	E334	50	14-058	67
13-004	42	E107	57	E340	45	14-061	67
13-005	40	E108	43	E341	43	14-062	67
13-006	43	E112	51	E342	45	17-003	71
13-007	39	E114	52	E348	51	17-105	67
13-008	40	E115	50	E351	50	17-106	67
13-009	40	E117	52	E379	55	29-126	77
13-010	44	E121	49	E380	51	40-079	77
13-011	40	E122	51	E387	45	E052	61
13-012	40	E124	41	E415	53	E107	61
13-013	45	E125	41	E415-01	53	E248	74
13-014	45	E126	41	E416	53	E249	74
13-020	45	E127	41	E416-01	53	E250	74
13-025	51	E128	41	E418	44	E251	74
13-026	46	E129	47	E422	43	E259	63
13-027	47	E145	42	E428	57	E260	63
13-028	47	E146	42	E430	53	E263	63
13-029	47	E187	49	E431	59	E264	63
13-030	47	E199	40	E432	53	E285	65
13-032	48	E204	51	E433	55	E286	65
13-033	48	E205	52	E434	55	E332	73
13-035	48	E207	51	E435	43	E352	74
13-037	45	E208	39			E353	74
13-038	45	E209	52	Colonne	61	E361	72
13-039	45	E210	51	Componibili		E362	72
13-042	40	E211	49			E363	66
13-045	55	E214	48	14-001	62	E364	66
13-046	43	E232	59	14-002	62	E365	66
13-047	58	E236	52	14-003	62	E366	66
13-050	46	E237	41	14-004	62	E369	62
13-051	46	E238	39	14-005	62	E390	68
13-052	46	E239	40	14-006	62	E391	68
13-053	46	E240	39	14-009	63	E392	70
13-054	46	E241	52	14-010	63	E397	68
14-039	57	E246	49	14-011	66	E398	68
14-046	58	E255	49	14-012	66	F025	61
14-047	58	E256	47	14-013	64	F130	61
14-054	57	E257	47	14-014	64	F402	75
E002	46	E265	52	14-015	64	F403	75
E014	45	E269	39	14-016	64	F404	75
E025	56	E270	44	14-017	64	F405	75
E030	56	E276	51	14-018	64	F406	75
E038	50	E277	49	14-019	64	F407	75
E052	57	E279	56	14-020	64	F408	75
E053	48	E280	51	14-021	65	F409	75
E068	47	E282	53	14-022	65	F430	76
E070	47	E297	56	14-025	71	F431	76
E072	41	E308	50	14-026	71	F432	76
E075	47	E321	50	14-027	71	G336	73
E077	48	E322	50	14-033	71	G392	72
E078	47	E323	54	14-034	71	G401	72
E081	41	E324	54	14-037	69	G405	74
E082	41	E325	43	14-038	69	G431	70
E086	51	E326	54	14-039	61	G432	70
E088	52	E327	54	14-040	69		
E091	40	E328	54	14-041	69		

COLONNE e COLONNE COMPONIBILI

COLUMNS & COMPOSABLE COLUMNS

Colonne
Columns

p.39

Colonne Componibili
Composable Columns

p.61



COLONNE

COLUMNS

Letture misure:

Measurement legenda:

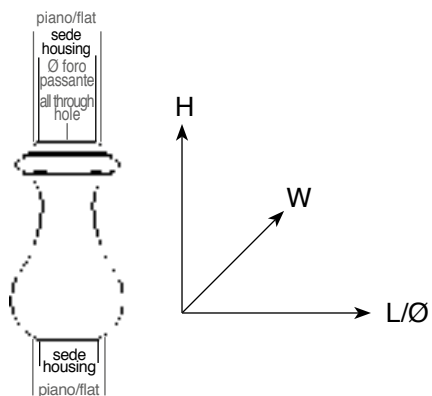

N.B. quota sedi specificata in NERO
housing dimension in BLACK

Tutti gli articoli filettati M 10/1 sono disponibili con filettatura 1/8 IPS. Per identificare la filettatura 1/8 IPS è necessario aggiungere il suffisso "-01" alla fine di ogni codice articolo.

All Framon threaded articles are M10/1 type; 1/8 IPS thread version is available on customer demand. To obtain 1/8 IPS suffix "-01" must be added at the end of the article code.

Esempio - Example:

13-029 = filetto/thread M 10/1

13-029-01 = filetto/thread 1/8 IPS

L= Lunghezza/Length
H= Altezza/Height
W= Larghezza/Width
Ø= Diametro/Diameter



E238
 $\varnothing 21 \times H 110$
 filetto/thread M 10/1

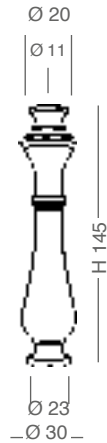

E208
 $\varnothing 30 \times H 145$

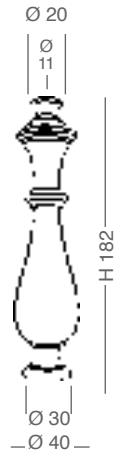

E240
 $\varnothing 40 \times H 182$

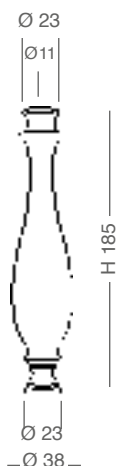

E101
 $\varnothing 38 \times H 185$



E269
 $\varnothing 47 \times H 190$

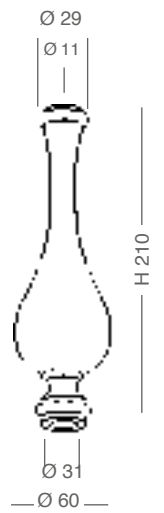

13-007
 $\varnothing 60 \times H 210$

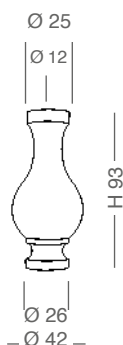

E199
Ø42 x H93

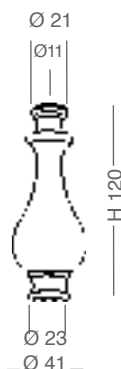

13-012
Ø41 x H120

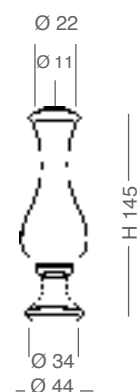

13-011
Ø44 x H145

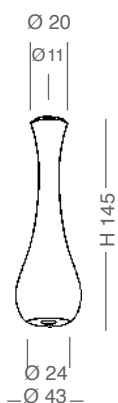

E239
Ø43 x H145



E091
Ø48 x H155

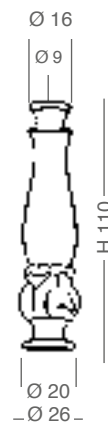

13-042
Ø26 x H110
filetto/thread M 10/1



13-009
Ø40 x H135



13-008
Ø46 x H163

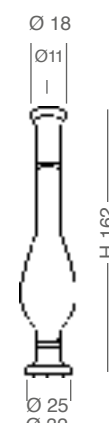

13-005
Ø32 x H162



E126
Ø20 x H75
filetto/thread M 10/1



E127
Ø20 x H75
filetto/thread M 10/1

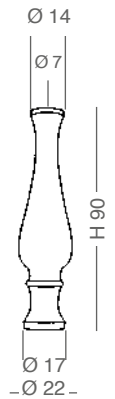

E128
Ø22 x H90
filetto/thread M 10/1

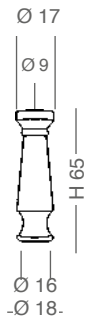

E125
Ø18 x H65
filetto/thread M 10/1



E082
Ø23 x H115
filetto/thread M 10/1



E081
Ø25 x H120
filetto/thread M 10/1

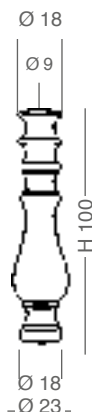

E124
Ø23 x H100
filetto/thread M 10/1



E072
Ø27 x H120
filetto/thread M 10/1

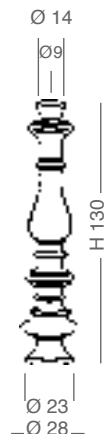

E237
Ø28 x H130
filetto/thread M 10/1

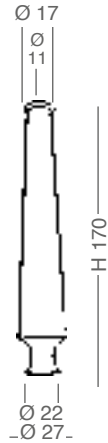

13-004
 $\varnothing 27 \times H 170$



E145
 $\varnothing 22 \times H 175$
 filetto/thread M 10/1

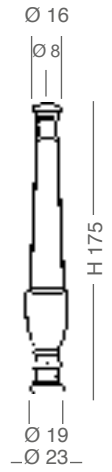

E146
 $\varnothing 23 \times H 175$
 filetto/thread M 10/1

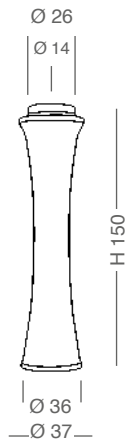

E103
 $\varnothing 37 \times H 150$



E106
 $\varnothing 39 \times H 255$

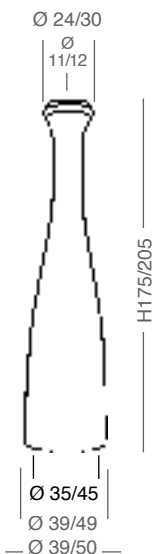

E100 **E105**
 $\varnothing 39 \times H 175$ $\varnothing 50 \times H 205$

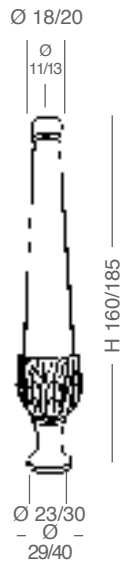

13-006 Ø29 x H160
13-046 Ø40 x H230

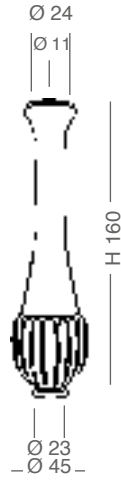

E108
Ø45 x H160

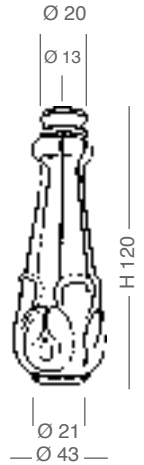

E341
Ø43 x H120

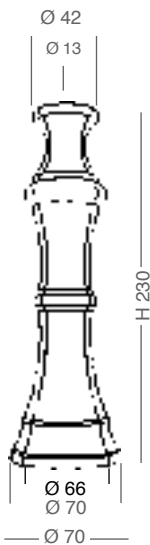

E435
Ø70 x H230



E325
Ø68 x H145

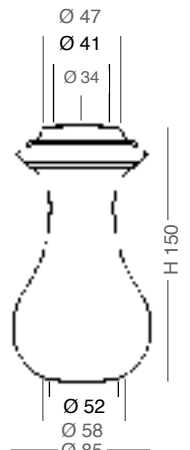

E422
Ø85 x H150

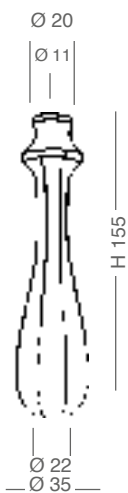

E418
Ø35 x H155

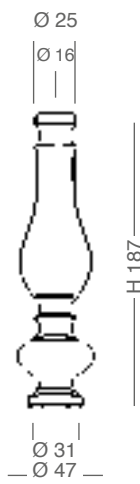

13-010
Ø47 x H187

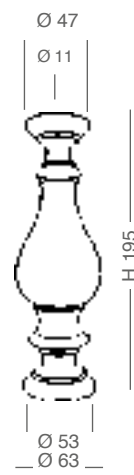

E270
Ø63 x H195

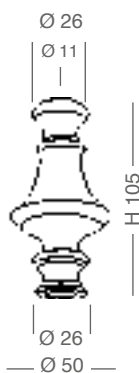

13-003
Ø50 x H105

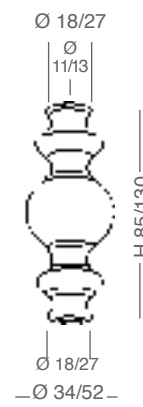

13-002 **13-001**
Ø34 x H85 Ø52 x H130

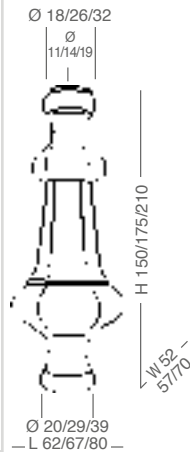

13-039
L62 x W52 x H150

13-038
L67 x W57 x H175

13-037
L80 x W70 x H210

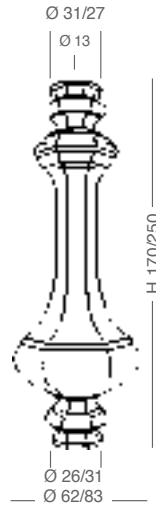

E340
Ø62 x H170

E014
Ø83 x H250

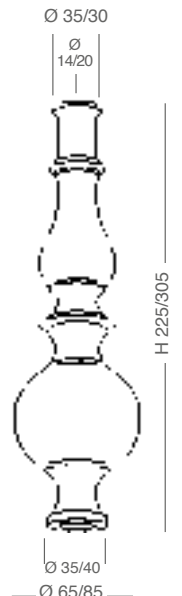

13-014
Ø65 x H225

13-013
Ø85 x H305

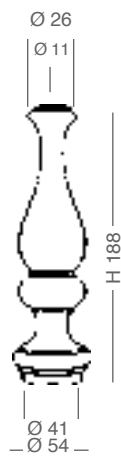

E342
Ø54 x H188

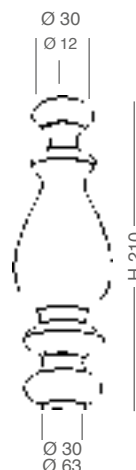

13-020
Ø63 x H210

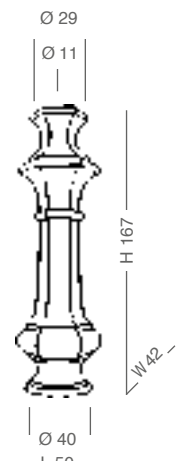

E387
L50 x W42 x H167

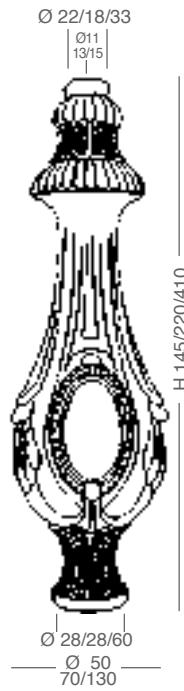

E002
 \varnothing 50 x H145

13-050
 \varnothing 130 x H410

13-026
 \varnothing 70 x H220

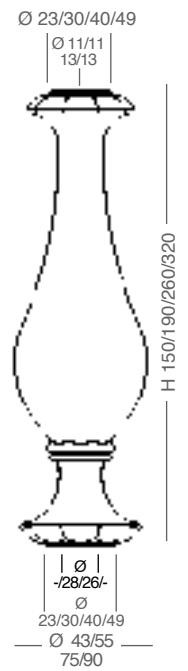

13-054
 \varnothing 43 x H150

13-052
 \varnothing 75 x H260

13-053
 \varnothing 55 x H190

13-051
 \varnothing 90 x H320

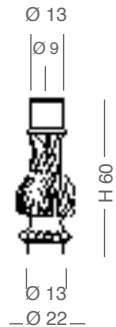

E068

Ø22 x H60
filetto/thread M 10/1



E070

Ø31 x H70
filetto/thread M 10/1

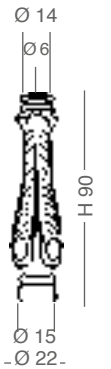

E129

Ø22 x H90
filetto/thread M 10/1

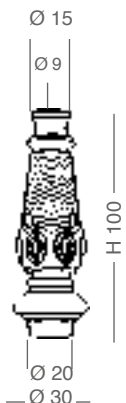

E075

Ø30 x H100
filetto/thread M 10/1



13-029

Ø40 x H105
filetto/thread M 10/1

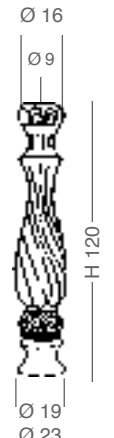

E078

Ø23 x H120
filetto/thread M 10/1



13-028

Ø28 x H110
filetto/thread M 10/1



E256

L40 x W40 x H110

E257

L57 x W60 x H145

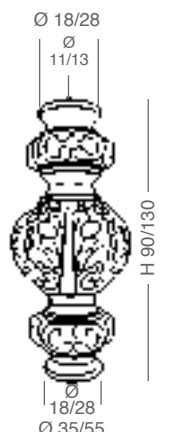

13-030

Ø35 x H90

13-027

Ø55 x H130

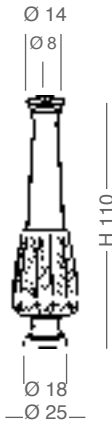

E077
 Ø25 x H110
 filetto/thread M 10/1



13-035
 Ø20 x H70
 filetto/thread M 10/1

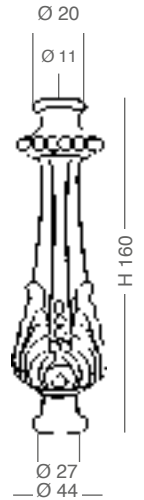

13-032
 Ø48 x H160



E214
 Ø45 x H150



E053
 Ø44 x H150

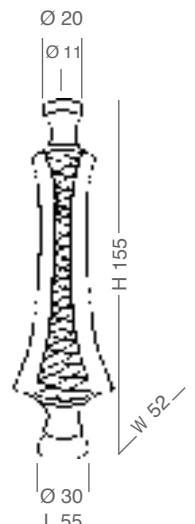

13-033
 L55 x W52 x H155

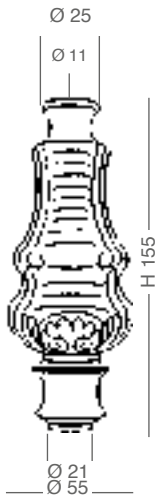

E277
Ø55 x H155

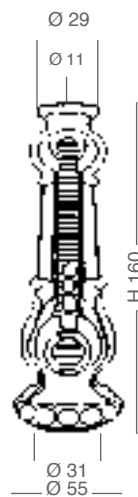

E187
Ø55 x H160

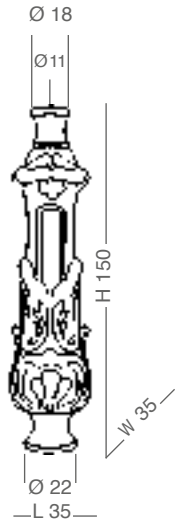

E255
L35 x W35 x H150

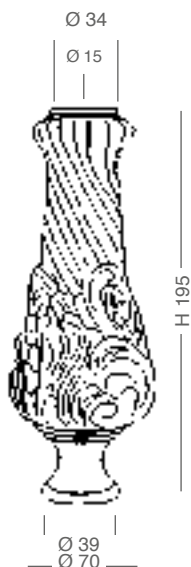

E121
Ø70 x H195

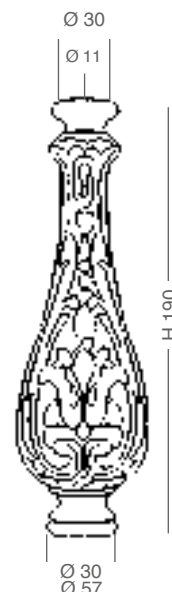

E211
Ø57 x H190
2 pezzi separati / 2 separated pieces

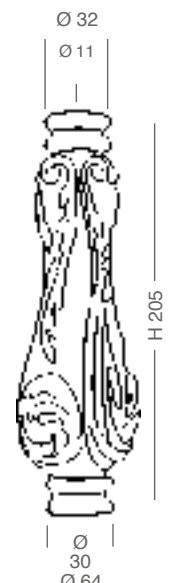

E246
Ø64 x H205



E334
Ø67 x H145

E333
Ø98 x H205

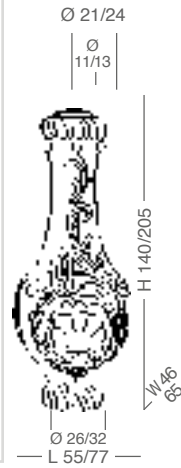

E322
L55 x W46 x H140

E321
L77 x W65 x H205

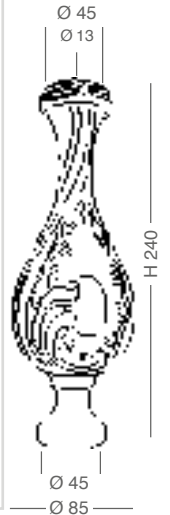

E308
Ø85 x H240

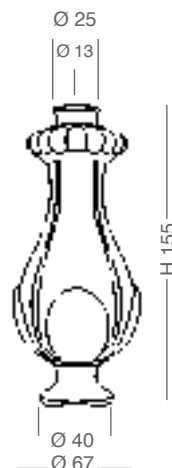

E351
Ø67 x H155

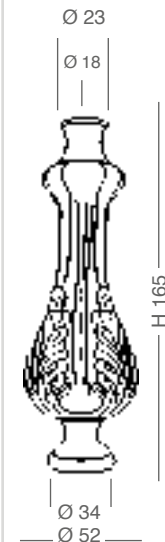

E038
Ø52 x H165

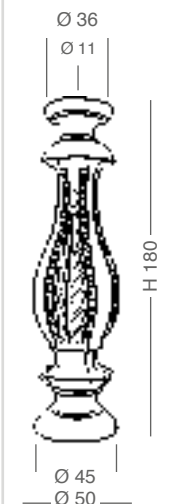

E115
Ø50 x H180



E112
Ø27 x H175

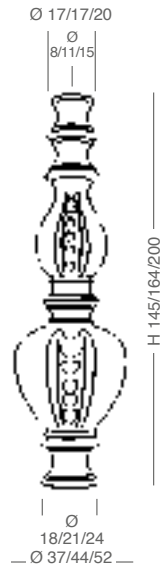

E204
Ø37 x H145
filetto/thread M 10/1

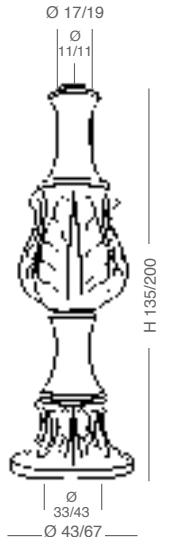

E086
Ø43 x H135

E207
Ø44 x H164

E210
Ø52 x H200

E122
Ø67 x H200



E380
Ø60 x H175

E348
Ø73 x H225

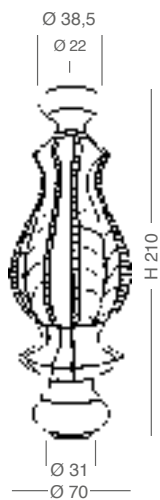

13-025
Ø70 x H210

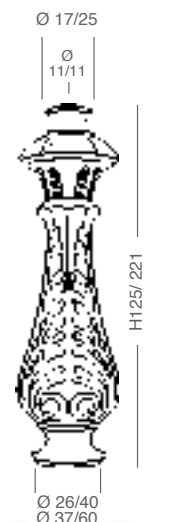

E276
Ø37 x H125

E280
Ø60 x H221



E236
 $\varnothing 40 \times H102$



E241
 $\varnothing 47 \times H195$



E088
 $\varnothing 38 \times H136$
 filetto/thread M 10/1

E117
 $\varnothing 46 \times H163$

E114
 $\varnothing 59 \times H200$

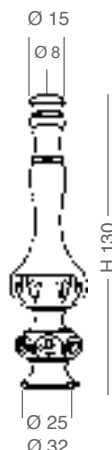

E205
 $\varnothing 32 \times H130$
 filetto/thread M 10/1

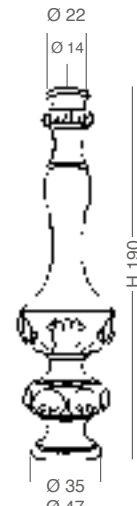

E209
 $\varnothing 47 \times H190$

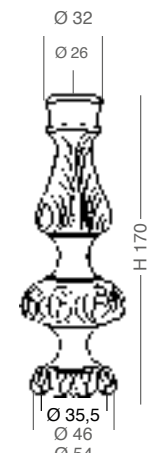

E265
 $\varnothing 54 \times H170$

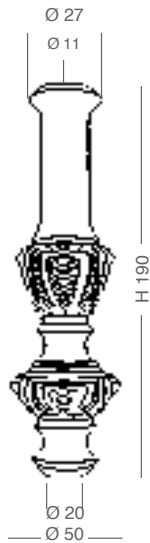

E282
Ø50 x H190

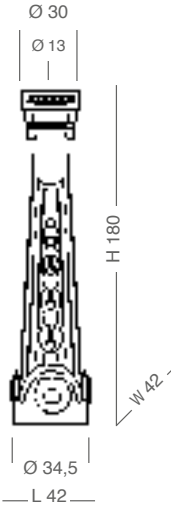

E430
L42 x W42 x H180

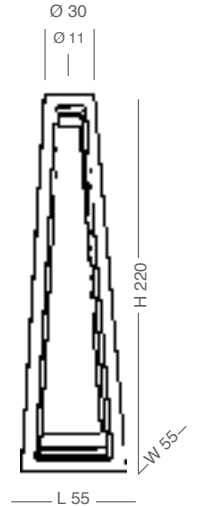

E432
L55 x W55 x H220

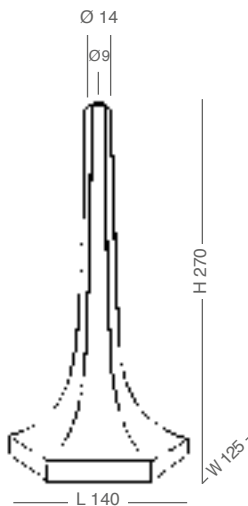

E415
L140 x W125 x H270
filetto/thread M 10/1

E415-01
L140 x W125 x H270
filetto/thread 1/8 IPS

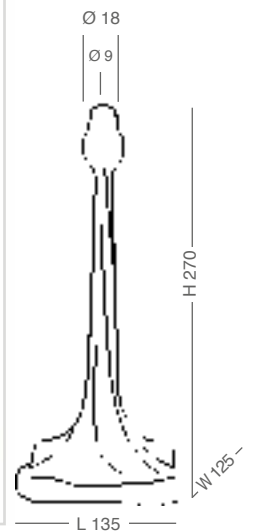

E416
L135 x W135 x H280
filetto/thread M 10/1

E416-01
L135 x W135 x H280
filetto/thread 1/8 IPS

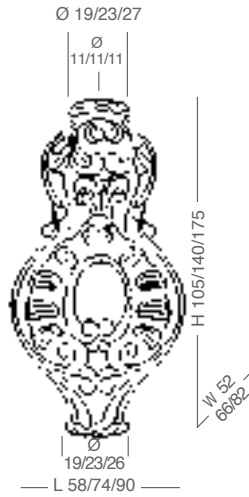

E328
L58 x W52 x H105

E327
L74 x W66 x H140

E326
L90 x W82 x H175

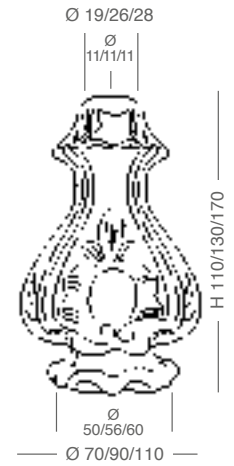

E329
Ø70 x H110

E330
Ø90 x H130

E331
Ø110 x H170

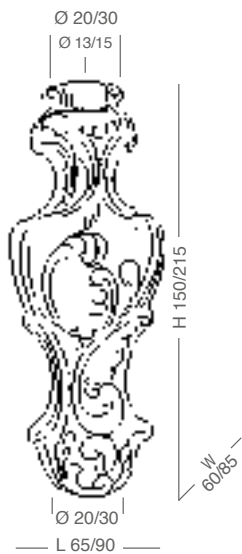

E324
L65 x W60 x H150

E323
L90 x W85 x H215

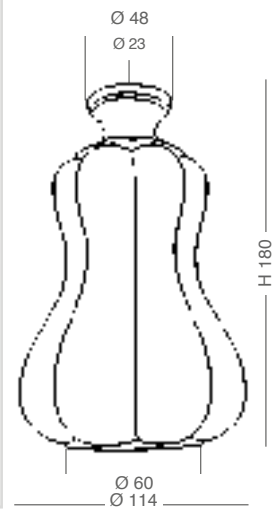

E379
Ø114 x H180

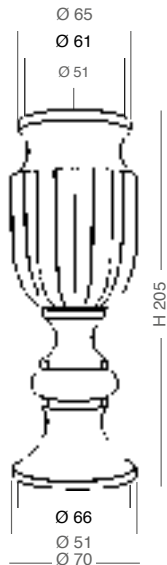

E434
Ø70 x H205

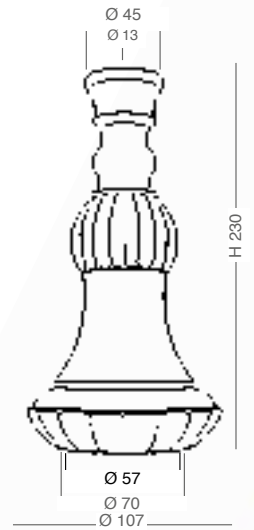

E433
Ø107 x H230

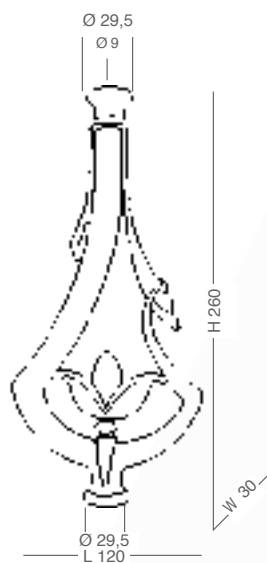

13-045
L120 x W30 x H260
filetto/thread M 10/1



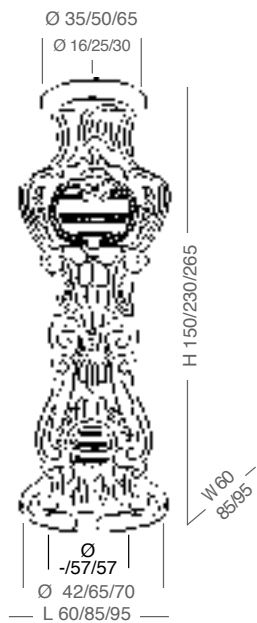

E279
 L60 x W60 x H150

E297
 L85 x W85 x H230



E025
 L63 x W63 x H235

E030
 L80 x W80 x H300

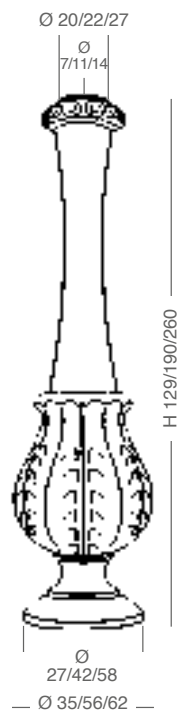

E052
Ø35 x H129
filetto/thread M 10/1

14-039
Ø56 x H190

E107
Ø62 x H260

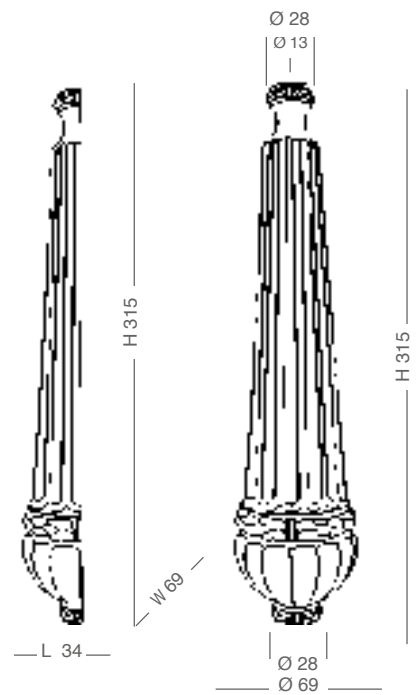

14-054
L34 x W69 x H315
1 pezzo / 1 piece

E428
Ø69 x H315
2 pezzi saldati / 2 pcs joined

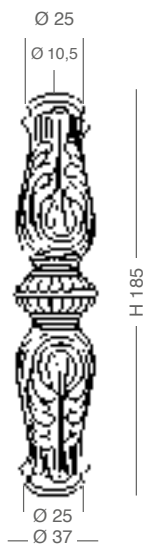

13-047
Ø37 x H185

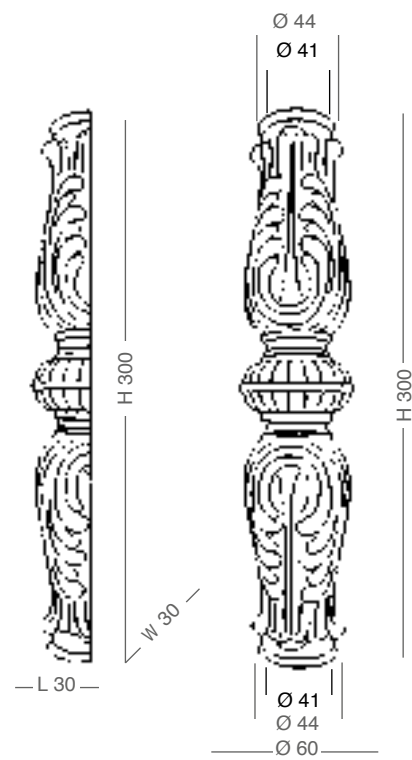

14-046
L60 x W30 x H300
1 pezzo / 1 piece

14-047
Ø60 x H300
2 pezzi saldati
2 pcs joined

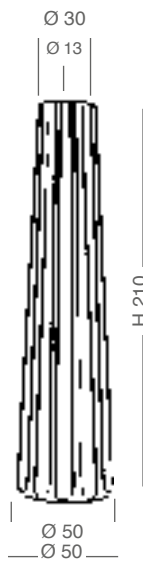

E431
 $\varnothing 50 \times H 210$

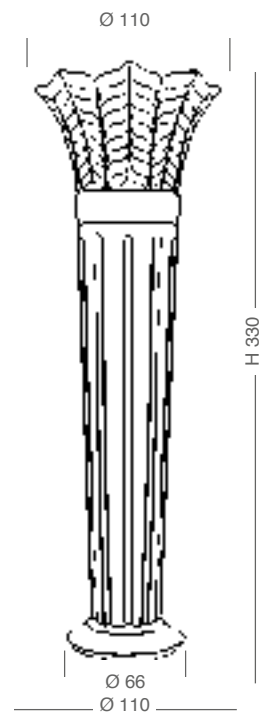

E232
 $\varnothing 110 \times H 330$
2 pezzi non saldati / 2 pcs not joined

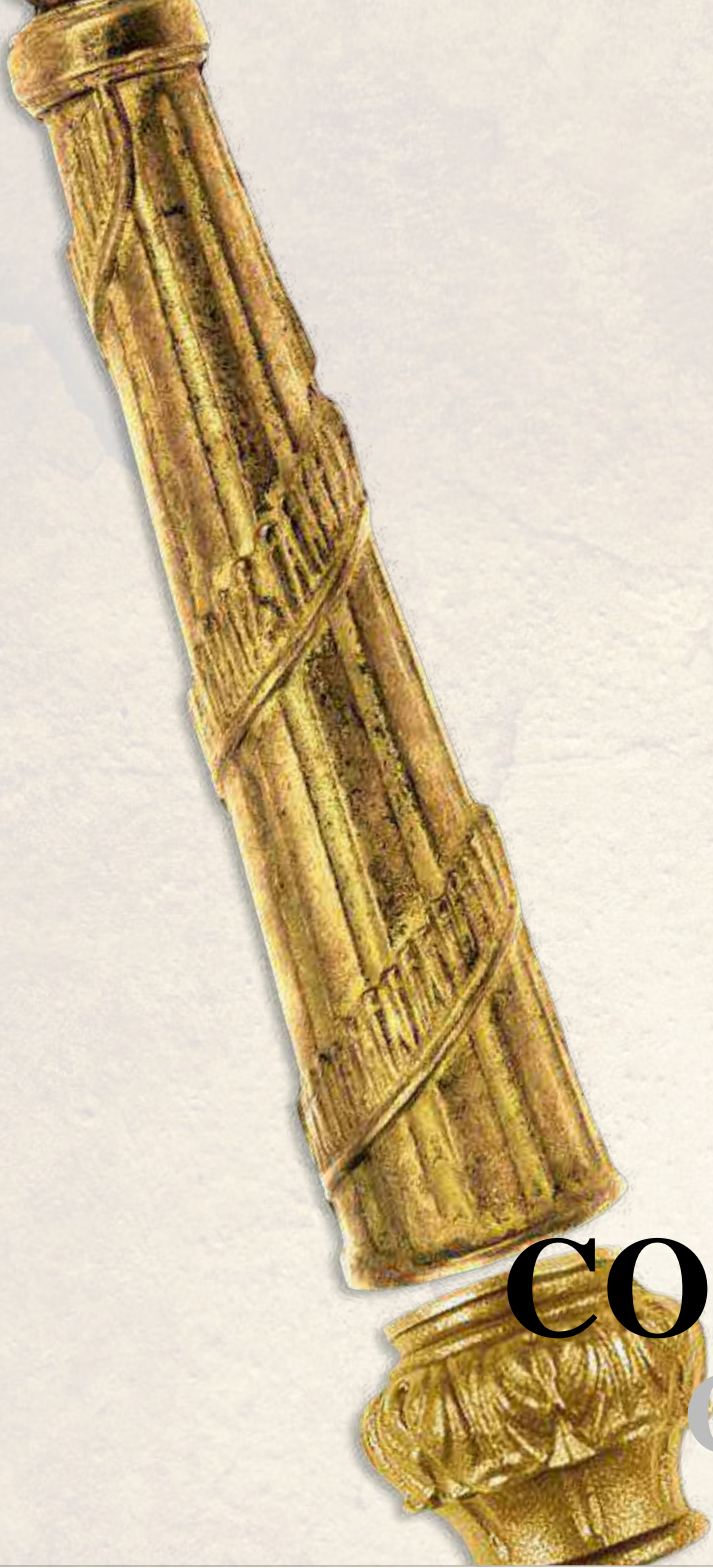

COLONNE COMPONIBILI

COMPOSABLE COLUMNS

Lettura misure:

Measurement legenda:

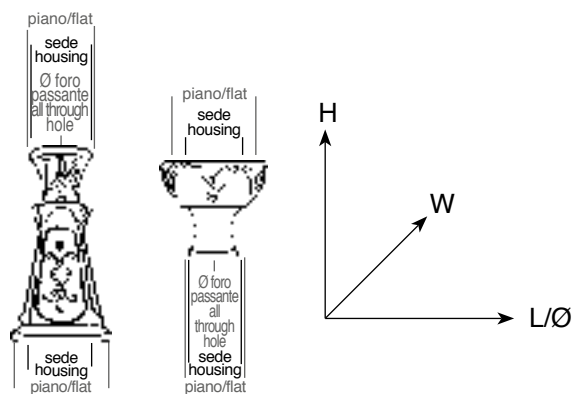

N.B. quota sedi specificata in NERO
housing dimension in BLACK

L= Lunghezza/Length

H= Altezza/Height

W= Larghezza/Width

Ø= Diametro/Diameter

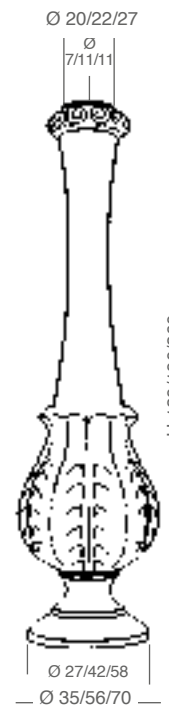

E052
 \varnothing 35 x H129
 filetto/thread M 10/1

14-039
 \varnothing 56 x H190

E107
 \varnothing 70 x H260

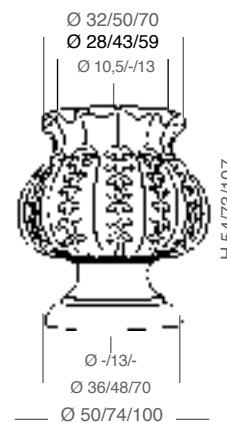

F130
 \varnothing 50 x H54

14-042
 \varnothing 74 x H73

F025
 \varnothing 100 x H107

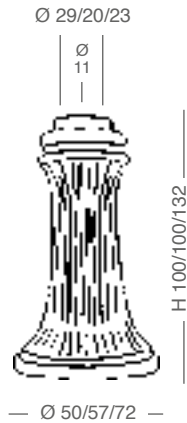

14-005
Ø50 x H100

14-003
Ø57 x H100

14-001
Ø72 x H132

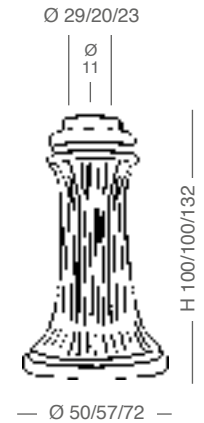

14-005
Ø50 x H100

14-003
Ø57 x H100

14-001
Ø72 x H132

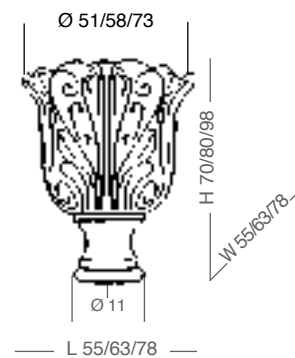

14-006
L55 x W55 x H70

14-004
L63 x W63 x H80

14-002
L78 x W78 x H98

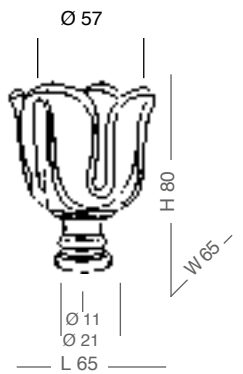

E369
L65 x W65 x H80

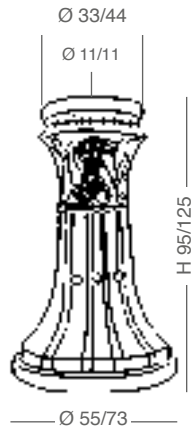

E259
Ø55 x H95

E260
Ø73 x H125

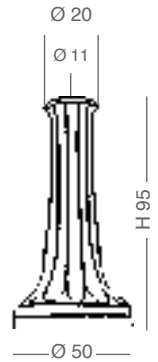

14-009
Ø50 x H95



E263
Ø64 x H75

E264
Ø85 x H100

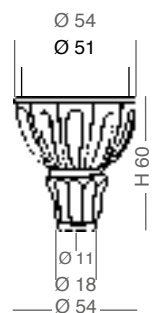

14-010
Ø54 x H60

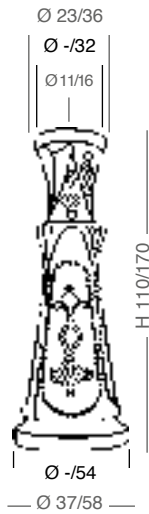

14-019
 \varnothing 37 x H110

14-017
 \varnothing 58 x H170

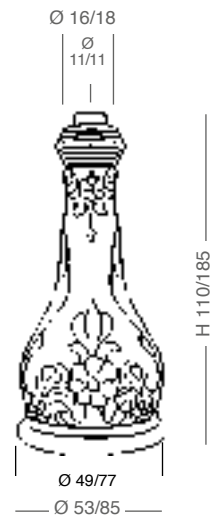

14-015
 \varnothing 53 x H110

14-013
 \varnothing 85 x H185



14-020
 \varnothing 42 x H45

14-018
 \varnothing 65 x H70

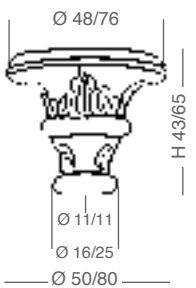

14-016
 \varnothing 50 x H43

14-014
 \varnothing 80 x H65

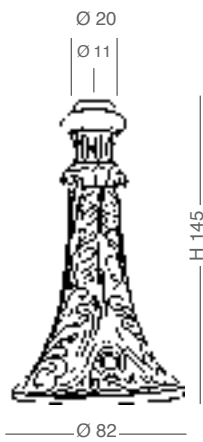

E285
Ø82 x H145

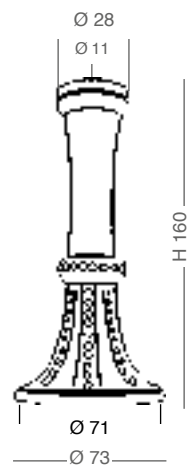

14-021
Ø73 x H160



E286
Ø87 x H70

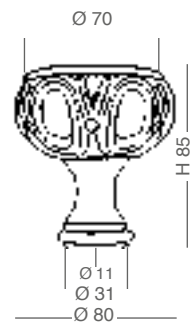

14-022
Ø80 x H85

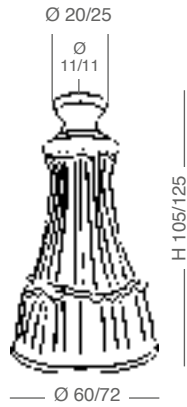

E365
Ø60 x H105

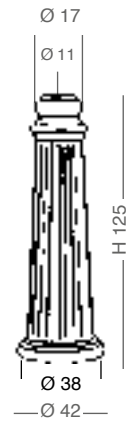

14-011
Ø42 x H125

E363
Ø72 x H125

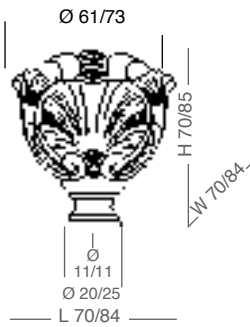

E366
L70 x W70 x H70

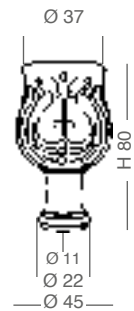

14-012
Ø45 x H80

E364
L84 x W84 x H85

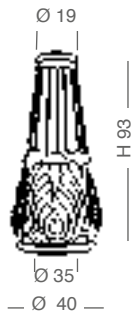

14-058
Ø40 x H93

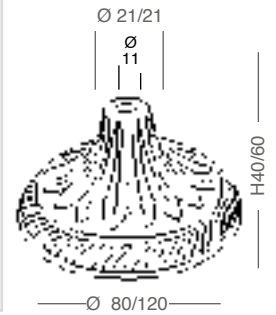

17-105
Ø120 x H60

17-106
Ø80 x H40



14-057
Ø30 x H40

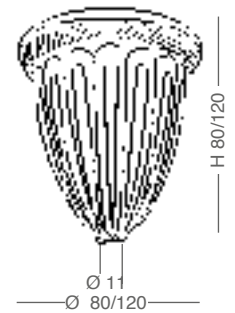

14-061
Ø120 x H120

14-062
Ø80 x H80

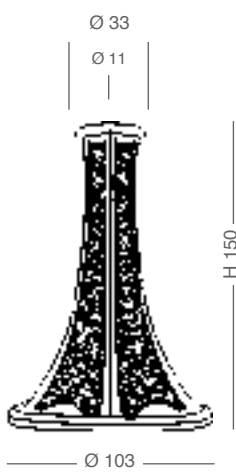

E390
 Ø103 x H150

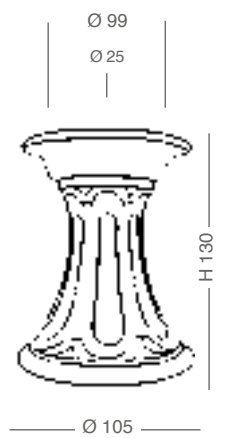

E397
 Ø105 x H130



E391
 Ø109 x H85

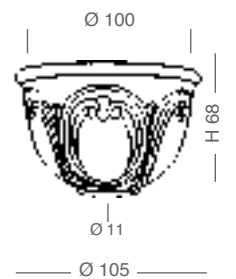

E398
 Ø105 x H68

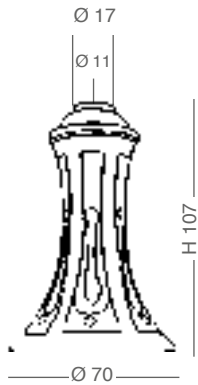

14-037
Ø70 x H107

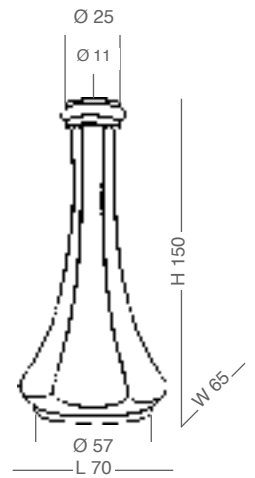

14-040
L70 x W65 x H150

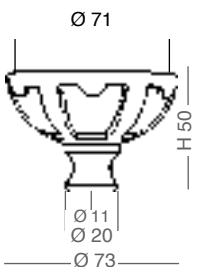

14-038
Ø73 x H50

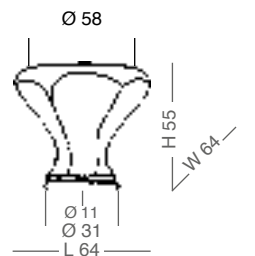

14-041
L64 x W64 x H55

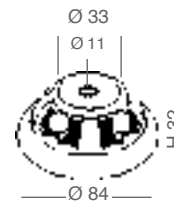

G432
Ø84 x H32

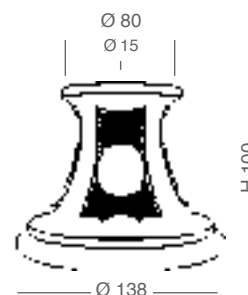

E392
Ø138 x H100

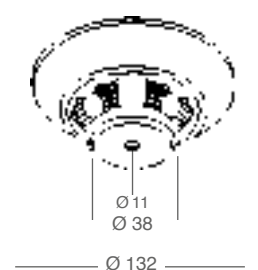

G431
Ø132 x H49

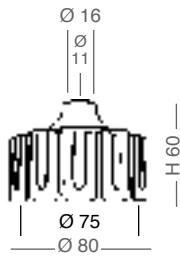

14-025
Ø80 x H60

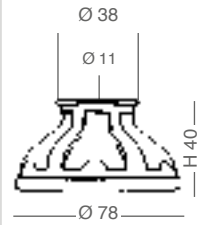

14-033
Ø78 x H40

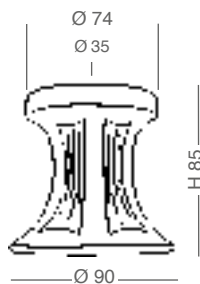

14-026
Ø90 x H85

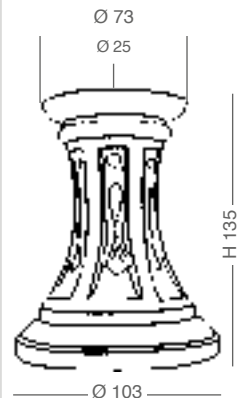

14-034
Ø103 x H135

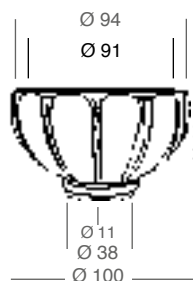

14-027
Ø100 x H60

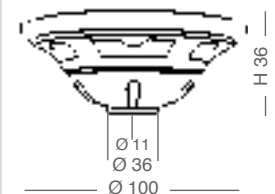

17-003
Ø100 x H36

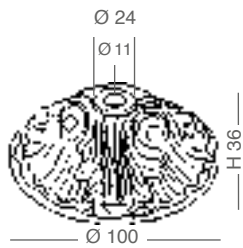

G401
Ø100 x H36

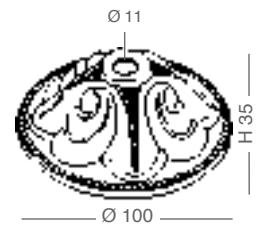

G392
Ø100 x H35

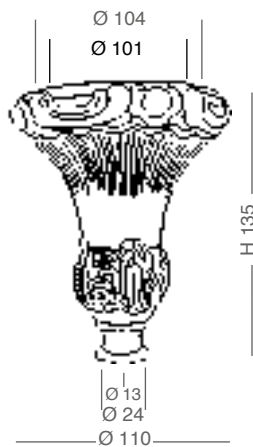

E362
Ø110 x H135

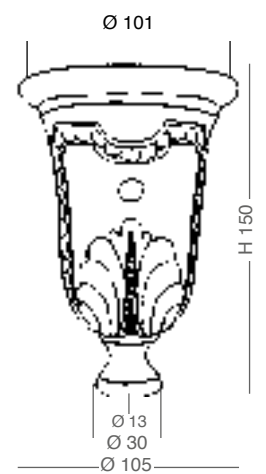

E361
Ø105 x H150

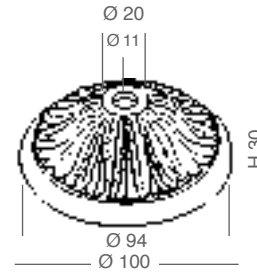

G336
Ø100 x H30

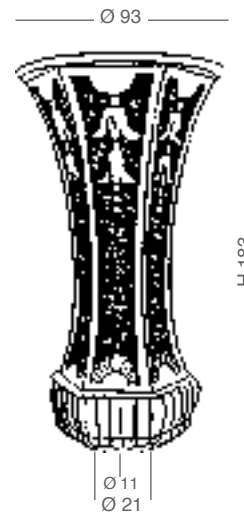

E332
Ø93 x H183

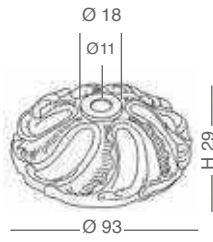

G405
Ø93 x H29

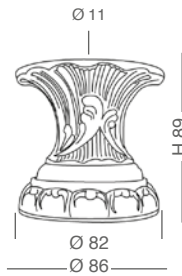

E352
Ø86 x H89

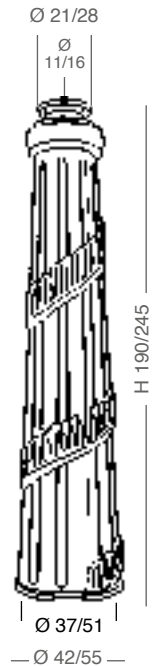

E251
Ø42 x H190

E249
Ø55 x H245

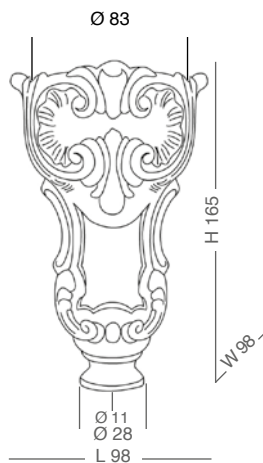

E353
L98 x W98 x H165

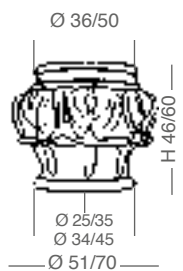

E250
Ø51 x H46

E248
Ø70 x H60

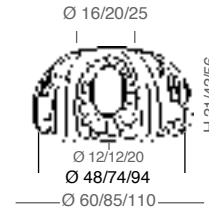

F408
Ø60 x H31

F409
Ø85 x H43

F402
Ø110 x H56

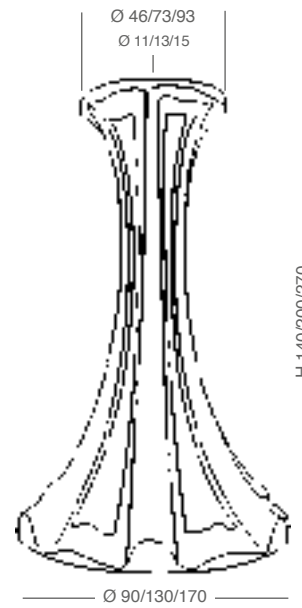

F405
Ø90 x H140

F406
Ø130 x H200

F407
Ø170 x H270

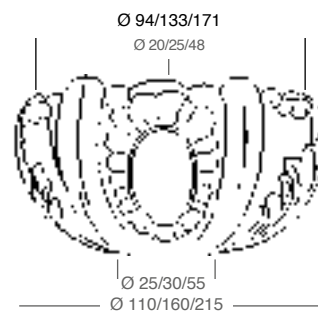

F402
Ø110 x H56
Ø94 sede int/impost

F403
Ø160 x H81
Ø133 sede int/impost

F404
Ø215 x H116
Ø172 sede int/impost

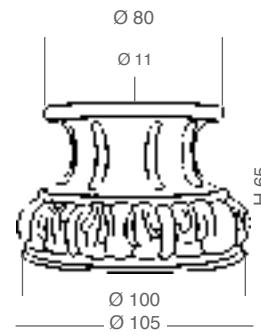

F432
 $\varnothing 105 \times H 65$

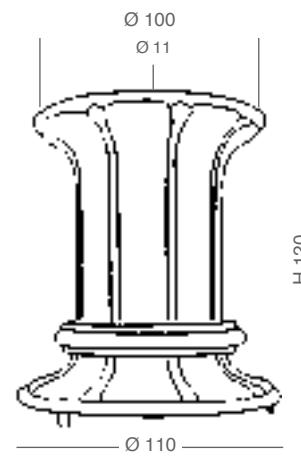

F431
 $\varnothing 110 \times H 120$

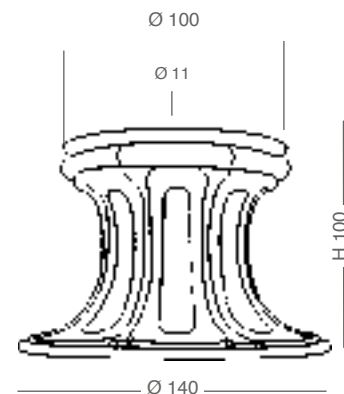

F430
 $\varnothing 140 \times H 100$



esempio di utilizzo
use example

29-126

L15 x W5 x H45

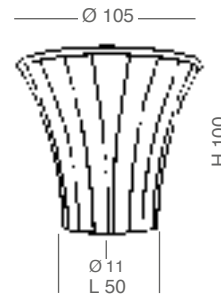

14-050

Ø105 x H100

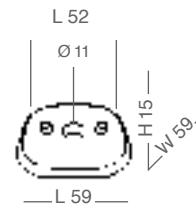

40-079

L59 x W59 x H15

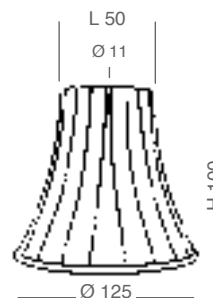

14-051

Ø125 x H100

Distanziali	81	F051	99	F173	92	F329	86	F504	106	Finali	113	L065	115
		F054	87	F176	98	F330	103	F507	105			L066	117
14-008	96	F055	104	F176	101	F337	95	F509	105	16-010	120	L067	116
14-032	99	F057	107	F178	104	F342	95	F510	105	16-011	120	L068	117
14-044	100	F058	107	F179	98	F343	93	F511	102	16-012	120	L085	118
14-045	100	F069	98	F179	101	F344	93	F513	105	16-013	120	L086	119
15-001	87	F069	101	F183	93	F345	93	F514	83	16-014	120	L087	119
15-002	87	F070	98	F187	89	F346	93			16-015	120	L089	119
15-003	81	F070	101	F194	86	F347	95	Sfere	109	16-016	120	L091	117
15-004	88	F071	98	F200	85	F348	95			16-017	120	L092	117
15-005	88	F071	101	F201	86	F349	95	16-018	110	21-001	113	L093	117
15-007	88	F072	98	F202	86	F351	95	16-019	110	21-002	113	L094	117
15-010	97	F072	101	F203	93	F352	85	16-020	110	21-003	113	L095	119
15-011	97	F083	107	F208	86	F353	85	16-021	110	21-004	113	L096	119
15-012	96	F085	106	F214	89	F354	85	16-022	109	21-005	113	L101	119
15-015	88	F086	107	F215	89	F356	84	16-022-02	109	21-006	113	L112	116
15-017	88	F087	106	F216	89	F357	84	16-023	109	21-008	116	L113	116
15-019	97	F088	107	F228	97	F359	84	16-023-02	109	21-010	116	L117	119
15-020	105	F090	106	F229	97	F363	93	16-024	109	21-011	116	L118	119
15-027	106	F091	107	F230	97	F364	103	16-024-02	109	21-012	116	L119	119
15-028	106	F093	106	F234	86	F365	103	16-025	109	21-013	117	L120	118
15-030	102	F094	107	F235	86	F379	104	16-025-02	109	21-016	118	L121	116
15-031	81	F095	106	F236	86	F381	90	16-026	109	21-017	114	L122	114
15-032	81	F096	107	F237	86	F382	90	16-026-02	109	21-018	118	L123	114
15-033	81	F098	106	F242	94	F388	83	16-027	109	21-020	118	L125	118
15-034	81	F099	87	F245	89	F391	103	16-027-02	109	21-021	117	L140	115
15-034-10	81	F101	100	F246	94	F392	81	16-028	109	21-022	117	L141	115
15-035	81	F102	91	F254	82	F393	94	16-028-02	109	21-033	114	L142	115
15-036	81	F103	87	F255	82	F394	103	16-029	109	21-034	114	L143	115
40-019	106	F105	100	F256	82	F396	104	16-029-02	109	21-035	114	L144	115
40-020	106	F106	91	F257	82	F400	104	16-030	109	5201-OTT	121	L147	113
40-021	106	F109	100	F258	82	F416	83	16-030-02	109	5230-OTT	121	L148	115
F001	81	F110	91	F259	82	F427	89	16-032	110	5280-OTT	121		
F002	89	F111	87	F260	82	F429	99	16-033	110	5290-OTT	121		
F003	89	F113	100	F261	82	F433	94	16-034	110	5415-OTT	121		
F004	88	F114	91	F262	87	F434	83	16-035	110	L001	119		
F005	87	F115	91	F263	83	F437	86	16-036	110	L003	116		
F006	87	F118	91	F265	82	F438	84	16-037	110	L007	116		
F007	88	F119	99	F266	82	F439	84	16-038	110	L019	114		
F009	89	F120	90	F269	86	F440	103	F138	111	L020	118		
F010	96	F121	90	F271	97	F441	102	F138-02	111	L029	118		
F016	96	F125	98	F272	97	F442	88	F142	111	L030	118		
F017	81	F125	101	F275	93	F443	83	F142-02	111	L036	120		
F018	84	F128	98	F276	85	F445	83	F147	111	L037	120		
F019	99	F128	101	F277	85	F446	102	F147-02	111	L039	114		
F024	98	F129	97	F278	93	F449	98	F152	111	L040	115		
F025	99	F130	99	F285	83	F449	101	F152-02	111	L041	113		
F026	94	F131	106	F286	81	F451	83	F152-10	111	L042	118		
F028	96	F132	106	F289	99	F457	105	F156	111	L043	120		
F029	96	F133	106	F297	96	F458	107	F156-02	111	L044	114		
F030	96	F135	87	F298	102	F459	107	F156-10	111	L050	119		
F031	96	F136	83	F300	89	F460	107	F231	111	L052	116		
F034	87	F137	83	F306	95	F461	82	F232	111	L053	119		
F035	100	F144	83	F307	95	F462	83	F233	111	L054	117		
F036	100	F150	96	F309	102	F478	102	F328	109	L055	117		
F037	100	F151	97	F310	102	F479	102	F464	109	L056	117		
F038	100	F158	92	F312	92	F488	85	F468	111	L057	117		
F043	91	F162	87	F317	105	F489	85	F468-02	111	L059	118		
F044	100	F163	90	F318	83	F490	94	F469	111	L060	114		
F048	97	F164	89	F325	85	F492	81	F470	111	L061	114		
F050	88	F166	105	F326	85	F498	82	F471	111	L062	114		

DISTANZIALI SFERE FINALI SPACERS SPHERES FINIALS

Distanziali
Spacers

p.81

Sfere
Spheres

p.109

Finali
Finials

p.113



DISTANZIALI SPACERS

Lettura misure:
Measurement legenda:

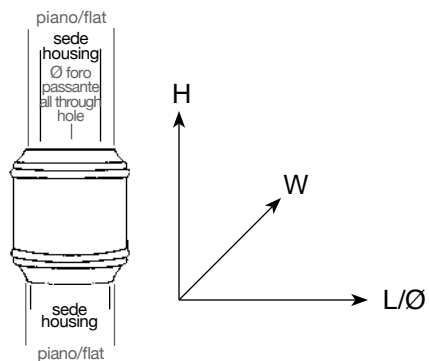

N.B. quota sedi specificata in NERO
housing dimension in BLACK

L= Lunghezza/Length
H= Altezza/Height
W= Larghezza/Width
Ø= Diametro/Diameter

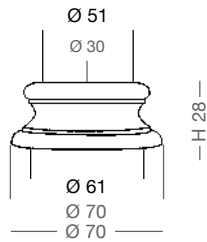

F492
Ø70 x H28

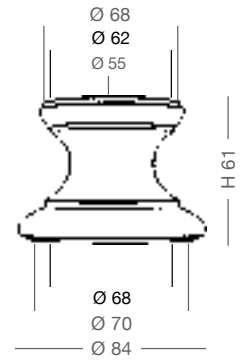

F017
Ø84 x H61

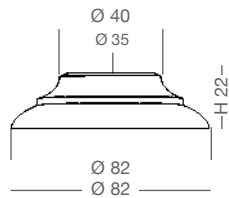

F392
Ø82 x H22

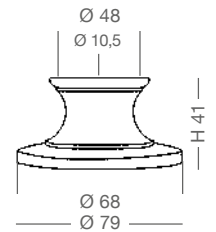

F286
Ø79 x H41

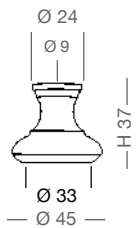

F001
Ø45 x H37
filetto/ thread M 10/1

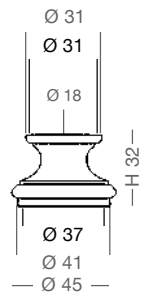

15-003
Ø45 x H32

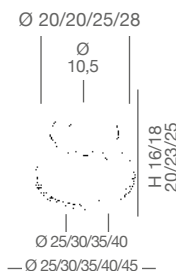

15-035 Ø25 x H16
15-034 Ø30 x H18
15-033 Ø35 x H20



15-034-10
Ø30 x H18

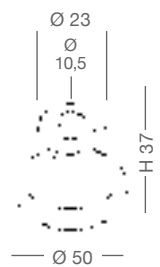

15-036
Ø60 x H37

15-032 Ø40 x H23
15-031 Ø45 x H25

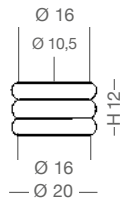

F498
Ø20 x H12

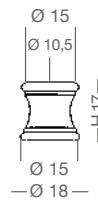

F254
Ø18 x H17

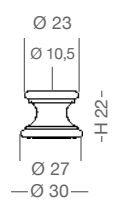

F461
Ø30 x H22

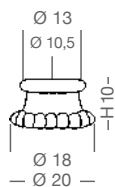

F255
Ø20 x H10

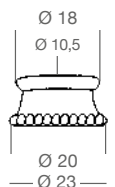

F256
Ø23 x H11

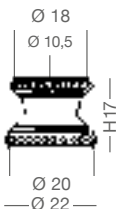

F259
Ø22 x H17

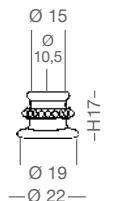

F258
Ø22 x H17

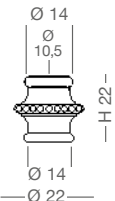

F260
Ø22 x H22

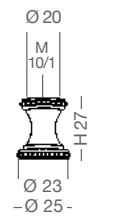

F261
Ø25 x H27

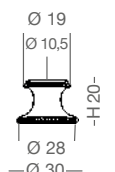

F266
Ø30 x H20

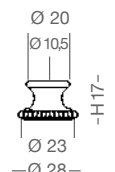

F257
Ø28 x H17

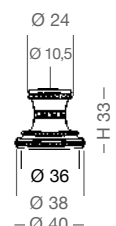

F265
Ø40 x H33

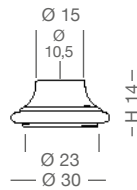

F416
Ø30 x H14

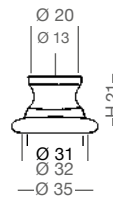

F434
Ø35 x H21

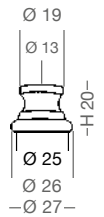

F263
Ø27 x H20

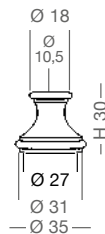

F443
Ø35 x H30

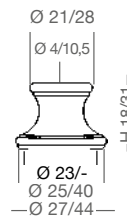

F462 **F451**
Ø27 x H18 Ø44 x H31

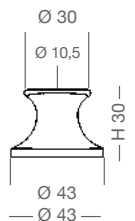

F285
Ø43 x H30

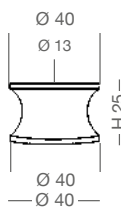

F514
Ø40 x H25

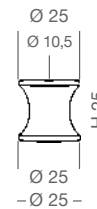

F445
Ø25 x H25

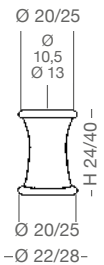

F137 **F136**
Ø22 x H24 Ø28 x H40

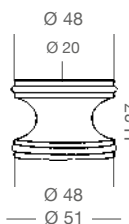

F388
Ø51 x H37

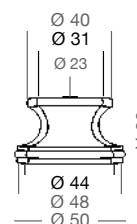

F144
Ø50 x H32

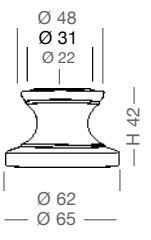

F318
Ø65 x H42

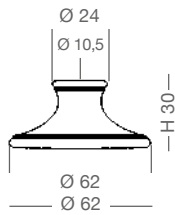

F439
Ø62 x H30

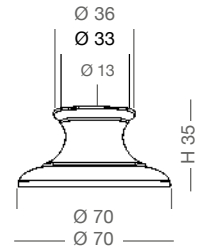

F438
Ø70 x H35

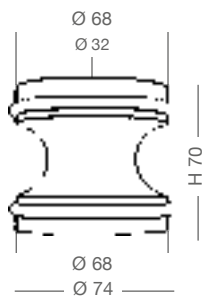

F357
Ø74 x H70

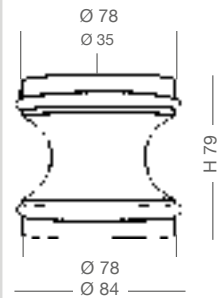

F356
Ø84 x H79

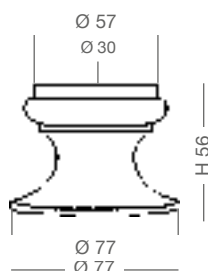

F359
Ø77 x H56

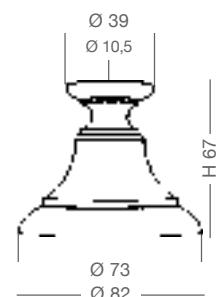

F018
Ø83 x H67

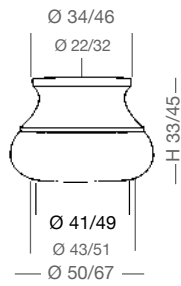

F489
 $\varnothing 50 \times H33$

F488
 $\varnothing 67 \times H45$

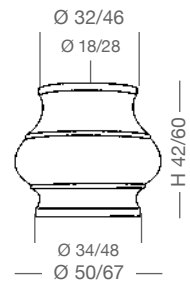

F277
 $\varnothing 50 \times H42$

F276
 $\varnothing 67 \times H60$

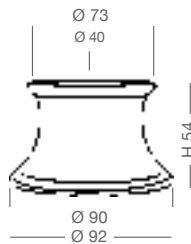

F200
 $\varnothing 92 \times H54$

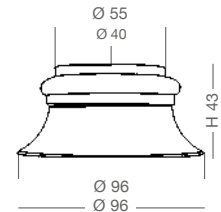

F352
 $\varnothing 96 \times H43$

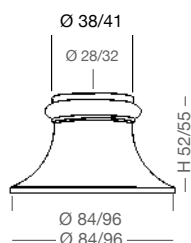

F354
 $\varnothing 84 \times H52$

F353
 $\varnothing 96 \times H55$

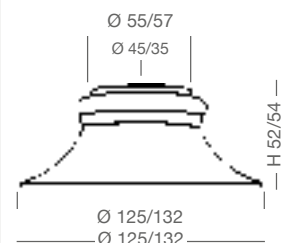

F326
 $\varnothing 125 \times H52$

F325
 $\varnothing 132 \times H54$

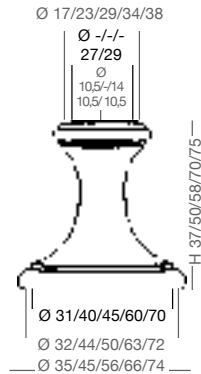

F006
 $\varnothing 35 \times H37$

F054
 $\varnothing 66 \times H70$



F005
 $\varnothing 26 \times H35$

F103
 $\varnothing 45 \times H56$

15-002
 $\varnothing 45 \times H50$

15-001
 $\varnothing 74 \times H75$

F099
 $\varnothing 35 \times H46$

F111
 $\varnothing 56 \times H58$

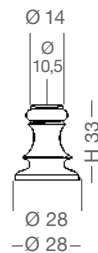

F162
 $\varnothing 28 \times H33$



F034
 $\varnothing 47 \times H50$

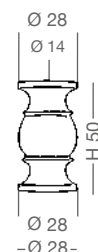

F135
 $\varnothing 28 \times H50$

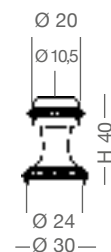

F262
 $\varnothing 30 \times H40$

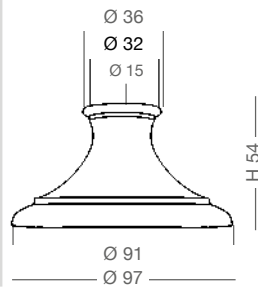

F437
Ø97 x H54

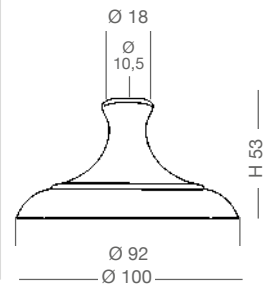

F269
Ø100 x H53

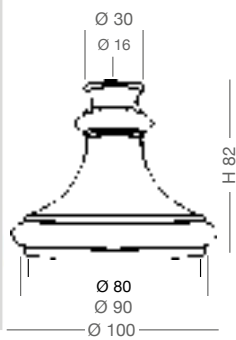

F329
Ø100 x H82

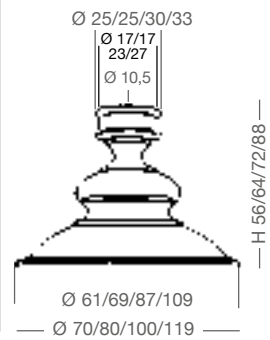

F237
Ø70 x H56

F235
Ø100 x H72

F236
Ø80 x H64

F234
Ø119 x H88

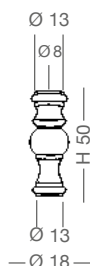

F004
 Ø18 x H50
 filetto/thread M 10/1

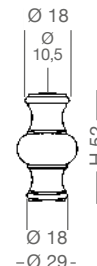

F007
 Ø29 x H52

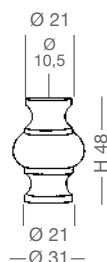

15-005
 Ø31 x H48



15-007
 Ø55 x H97

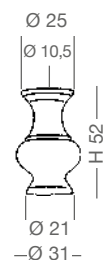

15-017
 Ø31 x H52

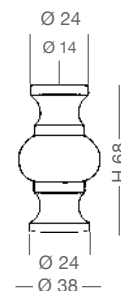

15-004
 Ø38 x H68

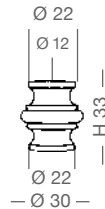

15-015
 $\varnothing 30 \times H 33$

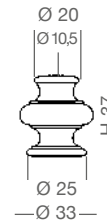

F442
 $\varnothing 33 \times H 37$

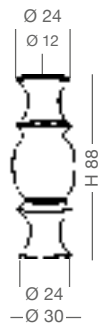

F050
 $\varnothing 30 \times H 88$

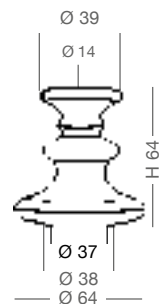

F187
 $\varnothing 64 \times H 64$

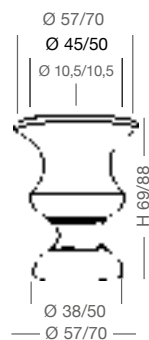

F427
 $\varnothing 57 \times H 69$

F300
 $\varnothing 70 \times H 88$

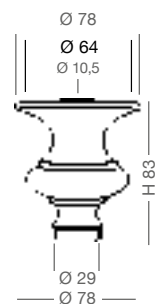

F164
 $\varnothing 78 \times H 83$



F214
Ø39 x H74



F215 **F216**
Ø52 x H95 Ø67 x H115

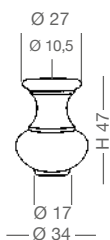

F002
Ø34 x H47



F009
Ø46 x H68

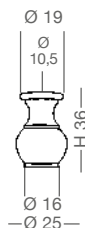

F003
Ø25 x H36

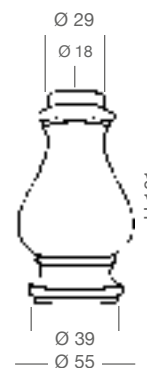

F245
Ø55 x H101

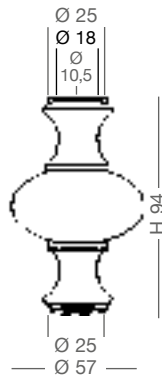

F115
Ø57 x H94

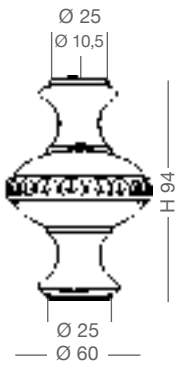

F118
Ø60 x H94

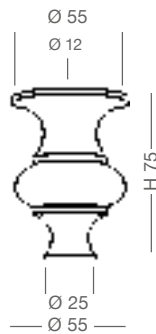

F278
Ø55 x H75

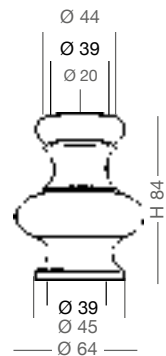

F275
Ø64 x H84

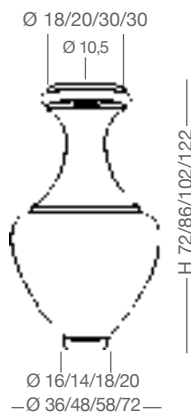

F163
Ø36 x H72

F121
Ø58 x H102

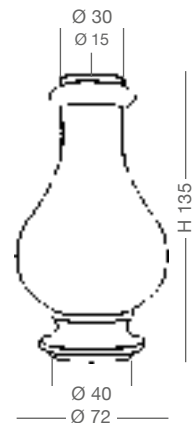

F381
Ø72 x H135

F120
Ø48 x H86

F382
Ø72 x H122

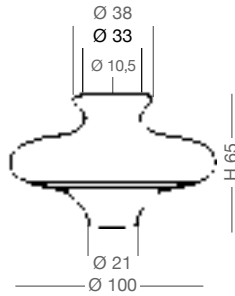

F194
Ø100 x H65

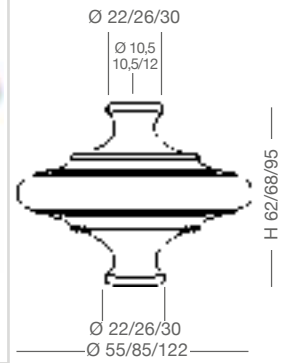

F202
Ø55 x H62

F208
Ø122 x H95

F201
Ø85 x H68



F102
Ø32 x H52

F110
Ø48 x H77

F106
Ø43 x H66

F114
Ø58 x H95
foro / hole Ø13

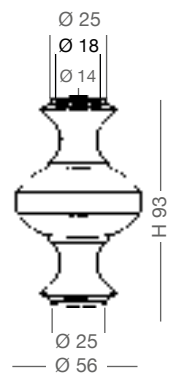

F043
Ø56 x H93

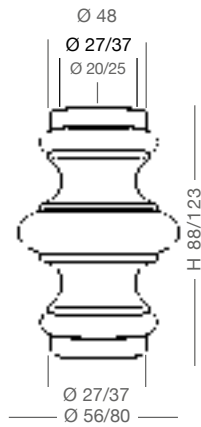

F344
 $\varnothing 56 \times H 88$

F345
 $\varnothing 80 \times H 123$

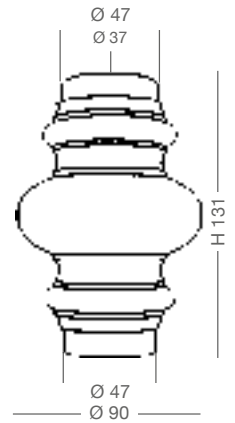

F346
 $\varnothing 90 \times H 131$

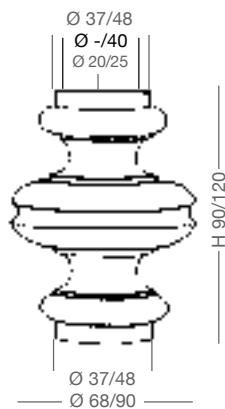

F343
 $\varnothing 68 \times H 90$

F363
 $\varnothing 90 \times H 120$

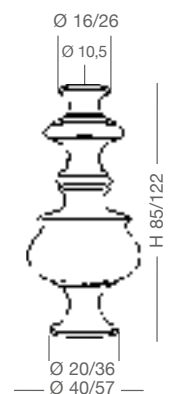

F183
 $\varnothing 40 \times H 85$

F203
 $\varnothing 57 \times H 122$

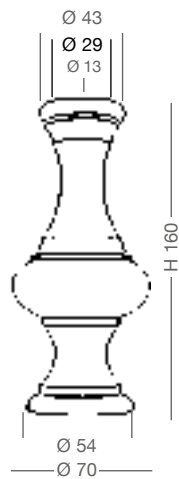

F242
Ø70 x H160

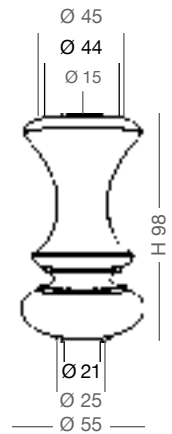

F490
Ø55 x H98

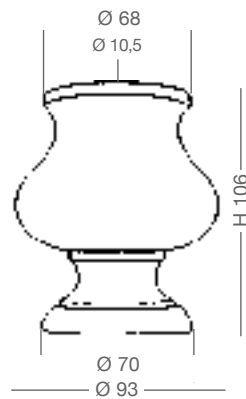

F026
Ø93 x H106

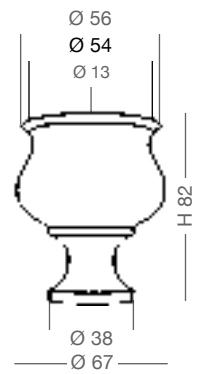

F393
Ø67 x H82

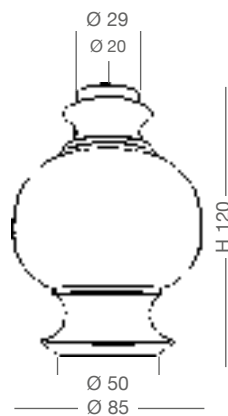

F246
Ø85 x H120

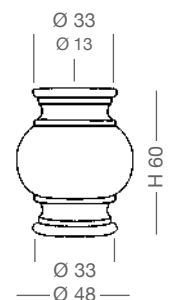

F433
Ø48 x H60

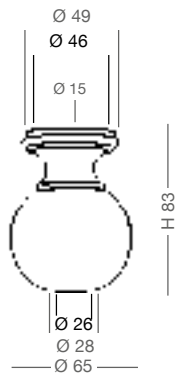

F342
Ø65 x H83

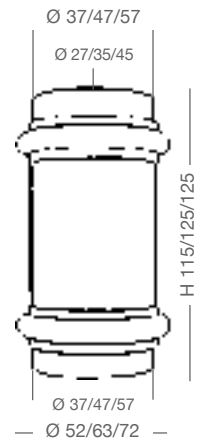

F347 Ø52 x H115
F348 Ø63 x H125
F349 Ø72 x H125

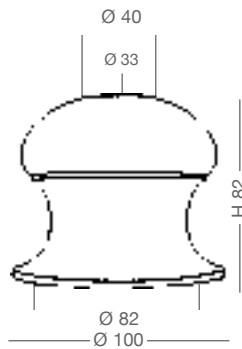

F337
Ø100 x H82

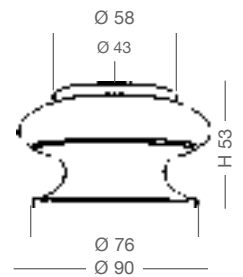

F351
Ø90 x H53

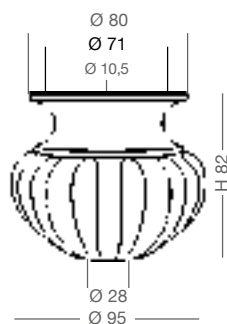

F306
Ø95 x H82

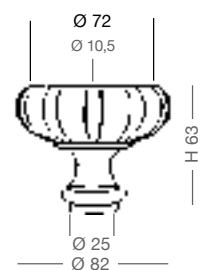

F307
Ø82 x H63

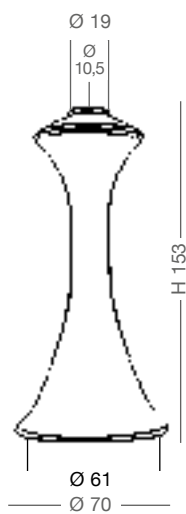

F158
 $\varnothing 70 \times H 153$

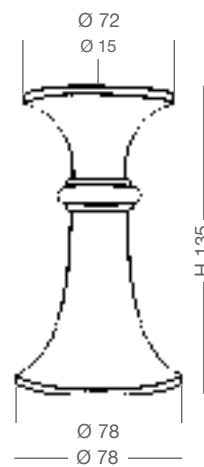

F312
 $\varnothing 78 \times H 135$

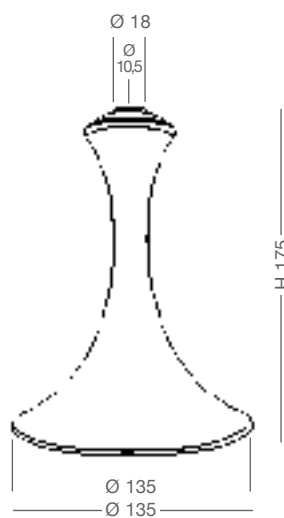

F173
 $\varnothing 135 \times H 175$



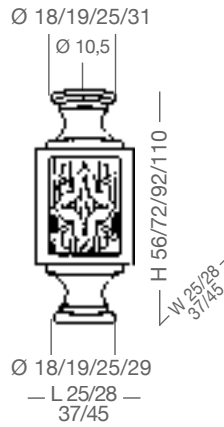

F031
L25 x W25 x H56

F029 Ø int. 13
L37 x W37 x H92



F297
Ø47 x H63

F030
L28 x W28 x H72

F028
L45 x W45 x H110

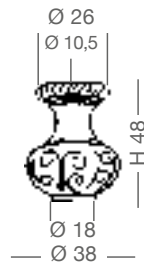

F150
Ø38 x H48

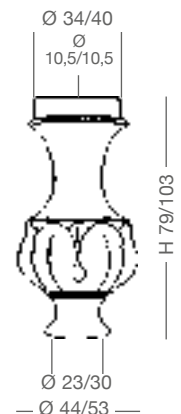

F010
Ø44 x H79

F016
Ø53 x H103



14-008
Ø45 x H48

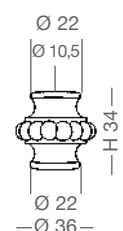

15-012
Ø36 x H34



F228
Ø42 x H74

F230
Ø70 x H113



F151
Ø40 x H74

F048
Ø60 x H103



F229
Ø57 x H92



F272
Ø42 x H58

F271
Ø57 x H78

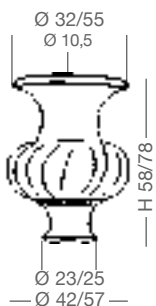

F129
Ø50 x H71



15-011
Ø33 x H49

15-010
Ø41 x H66



15-019
Ø44 x H63



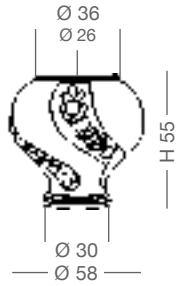

F051
Ø58 x H55
filetto/thread M 10/1

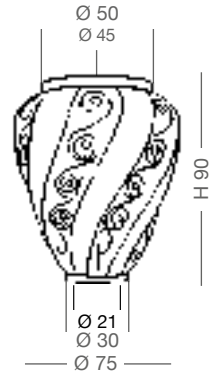

F019
Ø75 x H90

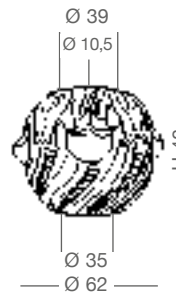

F289
Ø62 x H48

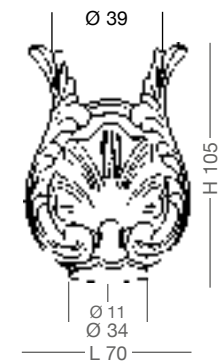

14-032
L70 x W70 x H105

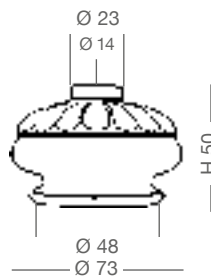

F429
Ø73 x H50

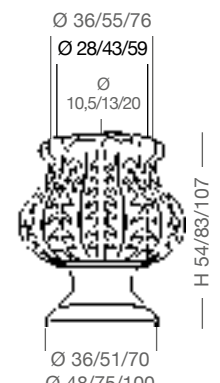

F130 Ø50 x H54
F119 Ø75 x H80
F025 Ø100 x H107



F101
Ø35 x H52

F109
Ø52 x H77

F105
Ø45 x H67

F113
Ø62 x H92
foro / hole Ø13



F044
Ø60 x H90

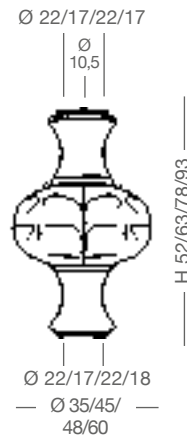

F038
Ø35 x H52

F036
Ø48 x H78

F037
Ø45 x H63

F035
Ø60 x H93
foro / hole Ø13

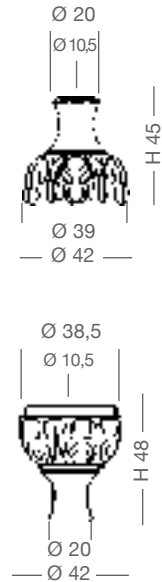

14-045
Ø42 x H45

14-044
Ø42 x H48

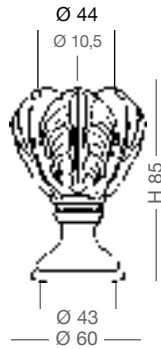

F125
Ø60 x H85

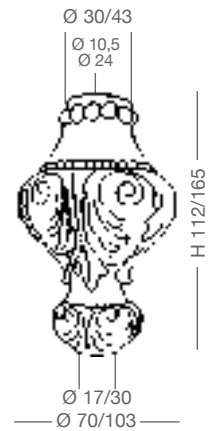

F176 **F179**
Ø70 x H112 Ø103 x H165

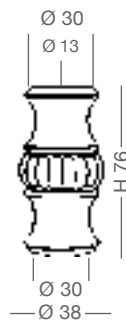

F128
Ø38 x H76

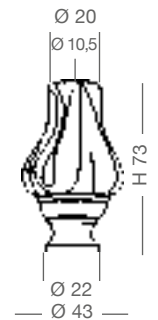

F449
Ø43 x H73

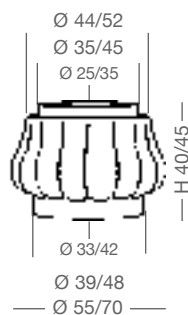

F070 **F069**
Ø55 x H40 Ø70 x H45

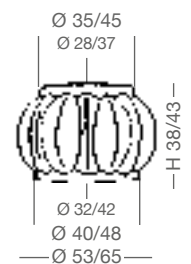

F071 **F072**
Ø53 x H38 Ø65 x H43

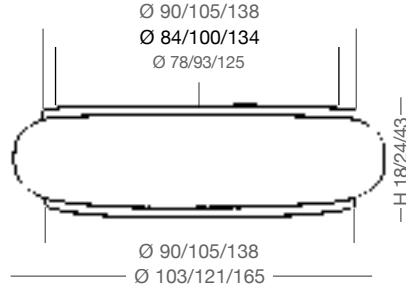

F309

$\varnothing 103 \times H18$

F298

$\varnothing 121 \times H24$

F310

$\varnothing 165 \times H43$

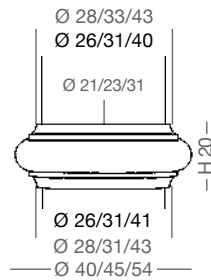

F479

$\varnothing 40 \times H20$

F478

$\varnothing 45 \times H20$

F441

$\varnothing 54 \times H20$

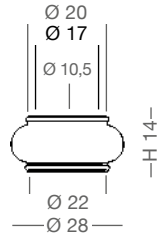

F446

$\varnothing 28 \times H14$

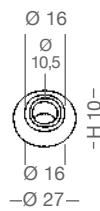

F511

$\varnothing 27 \times H10$

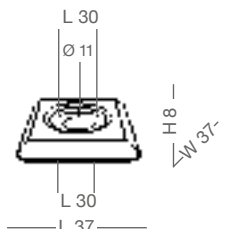

15-030

$L37 \times W37 \times H8$

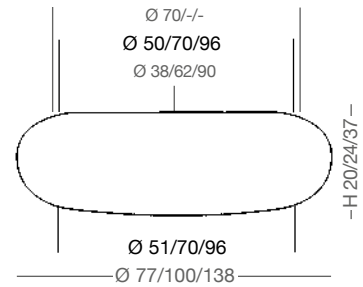

F391

$\varnothing 77 \times H20$

F330

$\varnothing 100 \times H24$

F365

$\varnothing 138 \times H37$

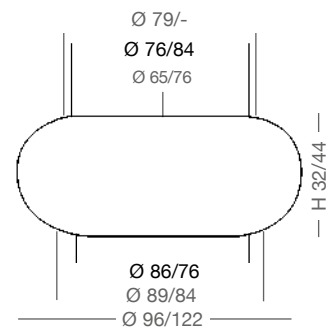

F440

$\varnothing 96 \times H32$

F364

$\varnothing 122 \times H44$

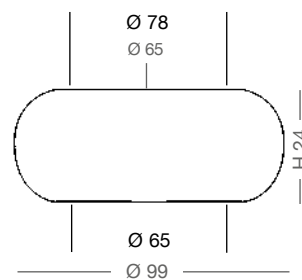

F394

$\varnothing 99 \times H24$

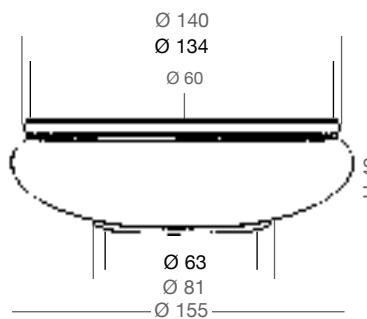

F178
 $\varnothing 155 \times H 49$

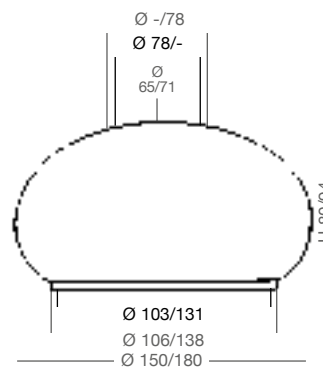

F379 **F396**
 $\varnothing 150 \times H 80$ $\varnothing 180 \times H 94$

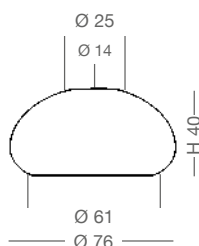

F055
 $\varnothing 76 \times H 40$

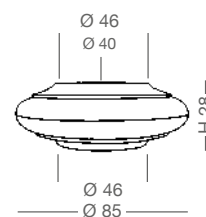

F400
 $\varnothing 85 \times H 28$

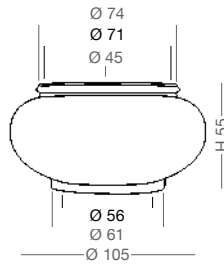

F166
Ø105 x H55

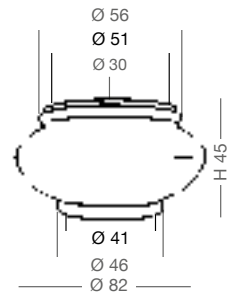

F317
Ø82 x H45

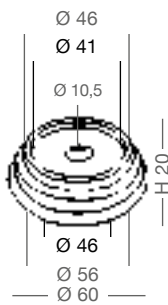

F509
Ø60 x H20

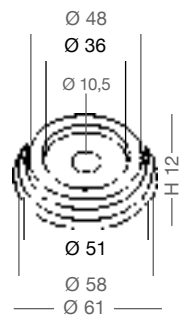

F513
Ø61 x H12

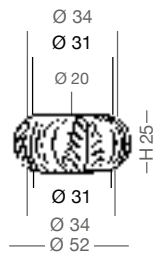

15-020
Ø52 x H25

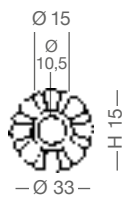

F457
Ø33 x H15

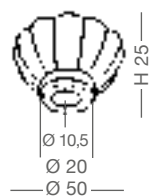

F507
Ø50 x H25

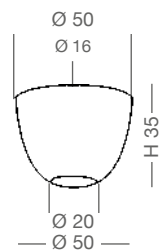

F510
Ø50 x H35

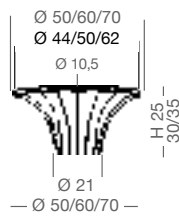

F098
Ø50 x H25

F095
Ø60 x H30

F093
Ø70 x H35

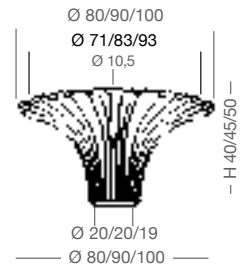

F090
Ø80 x H40

F087
Ø90 x H45

F085
Ø100 x H50

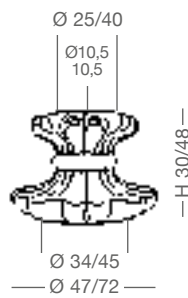

15-028
Ø47 x H30

15-027
Ø72 x H48

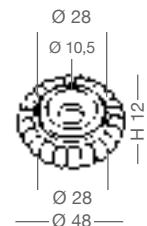

F504
Ø48 x H12

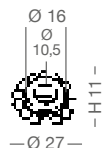

40-021
Ø27 x H11
pressofuso/die casted

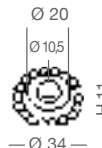

F131
Ø27 x H11
stampato a caldo/hot pressing

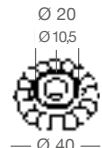

40-020
Ø34 x H11
pressofuso/die casted

F132
Ø34 x H11
stampato a caldo/hot pressing

40-019
Ø40 x H12
pressofuso/die casted

F133
Ø40 x H12
stampato a caldo/hot pressing

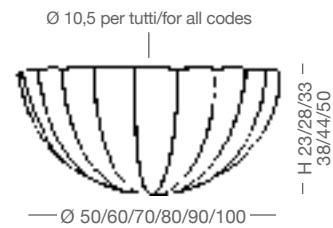

F096
Ø50 x H23

F094
Ø60 x H28

F091
Ø70 x H33

F088
Ø80 x H38

F086
Ø90 x H44

F083
Ø100 x H50

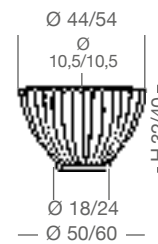

F058
Ø50 x H32

F057
Ø60 x H40

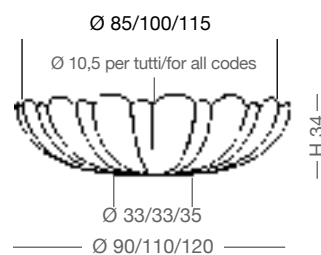

F458
Ø90 x H34

F459
Ø110 x H34

F460
Ø120 x H34



SFERE

SPHERES

Lettura misure:
Measurement legenda:

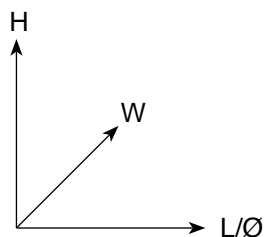
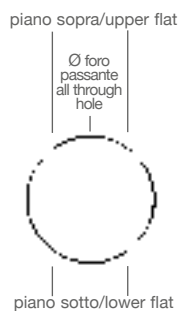

L= Lunghezza/Length
H= Altezza/Height
W= Larghezza/Width
Ø= Diametro/Diameter



F464

Ø25 x H23
filetto/thread M 10/1

F328

Ø32 x H30
filetto/thread M 10/1

16-022

Ø50 x H48
filetto/thread M 10/1

16-022-02

Ø50 x H45
2 fori/2 holes Ø11

16-023

Ø60 x H58
filetto/thread M 10/1

16-023-02

Ø60 x H55
2 fori/2 holes Ø11

16-024

Ø70 x H68
filetto/thread M 10/1

16-024-02

Ø70 x H65
2 fori/2 holes Ø11

16-025

Ø80 x H78
filetto/thread M 10/1

16-025-02

Ø80 x H75
2 fori/2 holes Ø11

16-026

Ø90 x H88
filetto/thread M 10/1

16-026-02

Ø90 x H85
2 fori/2 holes Ø11

16-027

Ø100 x H98
filetto/thread M 10/1

16-027-02

Ø100 x H95
2 fori/2 holes Ø11

16-028

Ø110 x H108
filetto/thread M 10/1

16-028-02

Ø110 x H105
2 fori/2 holes Ø11

16-029

Ø130 x H128
filetto/thread M 10/1

16-029-02

Ø130 x H125
2 fori/2 holes Ø11

16-030

Ø160 x H158
filetto/thread M 10/1

16-030-02

Ø160 x H155
2 fori/2 holes Ø11



16-032

Ø50 x H45

2 fori passanti /2 all through holes Ø11

16-033

Ø60 x H55

2 fori passanti /2 all through holes Ø11

16-034

Ø70 x H65

2 fori passanti /2 all through holes Ø11

16-035

Ø80 x H75

2 fori passanti /2 all through holes Ø11

16-036

Ø90 x H85

2 fori passanti /2 all through holes Ø11

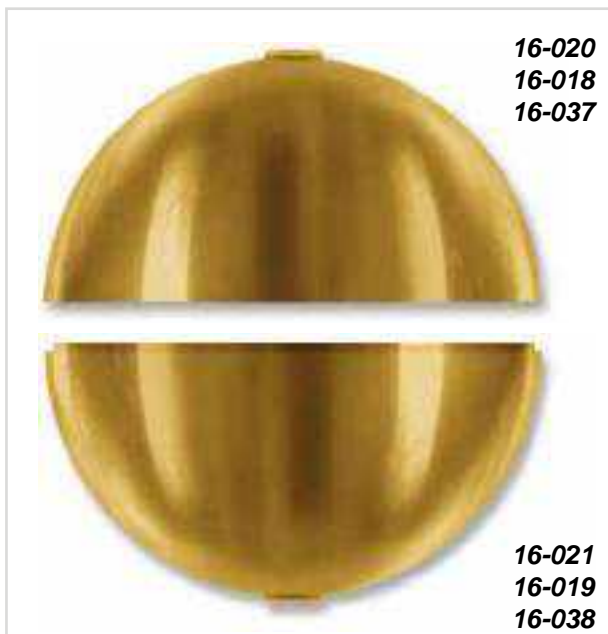

16-020

16-018

16-037

16-020

Ø80 x H41

piano sopra/upper flat Ø20

primo foro/first hole Ø11

16-021

Ø80 x H41 - maschio/male

piano sotto/lower flat Ø20

primo foro/first hole Ø11

16-018

Ø100 x H51

piano sopra/upper flat Ø20

primo foro/first hole Ø11

16-019

Ø100 x H51 - maschio/male

piano sotto/lower flat Ø20

primo foro/first hole Ø11

16-037

Ø120 x H60

piano sotto/lower flat Ø20

primo foro/first hole Ø11

16-038

Ø120 x H60 - maschio/male

piano sopra/upper flat Ø20

primo foro/first hole Ø11



F231

Ø60 x H40
2 fori/2 holes Ø11
2 imposte/2 pre-housing Ø20

F471

Ø62 x H43
filetto/thread M 10/1

F233

Ø80 x H54
2 fori/2 holes Ø20
2 imposte/2 pre-housing Ø30

F469

Ø80 x H58
filetto/thread M 10/1

F232

Ø100 x H73
2 fori/2 holes Ø30
2 imposte/2 pre-housing Ø40

F470

Ø100 x H78
filetto/thread M 10/1



F138

Ø60 x H28
filetto passante M 10/1
all through thread M 10/1

F138-02

Ø60 x H28
foro passante Ø11
all through hole Ø11

F142

Ø80 x H38
filetto passante M 10/1
all through thread M 10/1

F142-02

Ø80 x H38
foro passante Ø11
all through hole Ø11

F147

Ø100 x H48
filetto passante M 10/1
all through thread M 10/1

F147-02

Ø100 x H48
foro passante Ø11
all through hole Ø11

F152

Ø130 x H63
filetto passante M 10/1
all through thread M 10/1

F152-02

Ø130 x H63
foro passante Ø11
all through hole Ø11

F152-10

Ø130 x H63
senza foro/without hole

F468

Ø250 x H125
filetto passante M 10/1
all through thread M 10/1

F468-02

Ø250 x H125
foro passante Ø11
all through hole Ø11

F156

Ø160 x H78
filetto passante M 10/1
all through thread M 10/1

F156-02

Ø160 x H78
foro passante Ø11
all through hole Ø11

F156-10

Ø160 x H78
senza foro/without hole

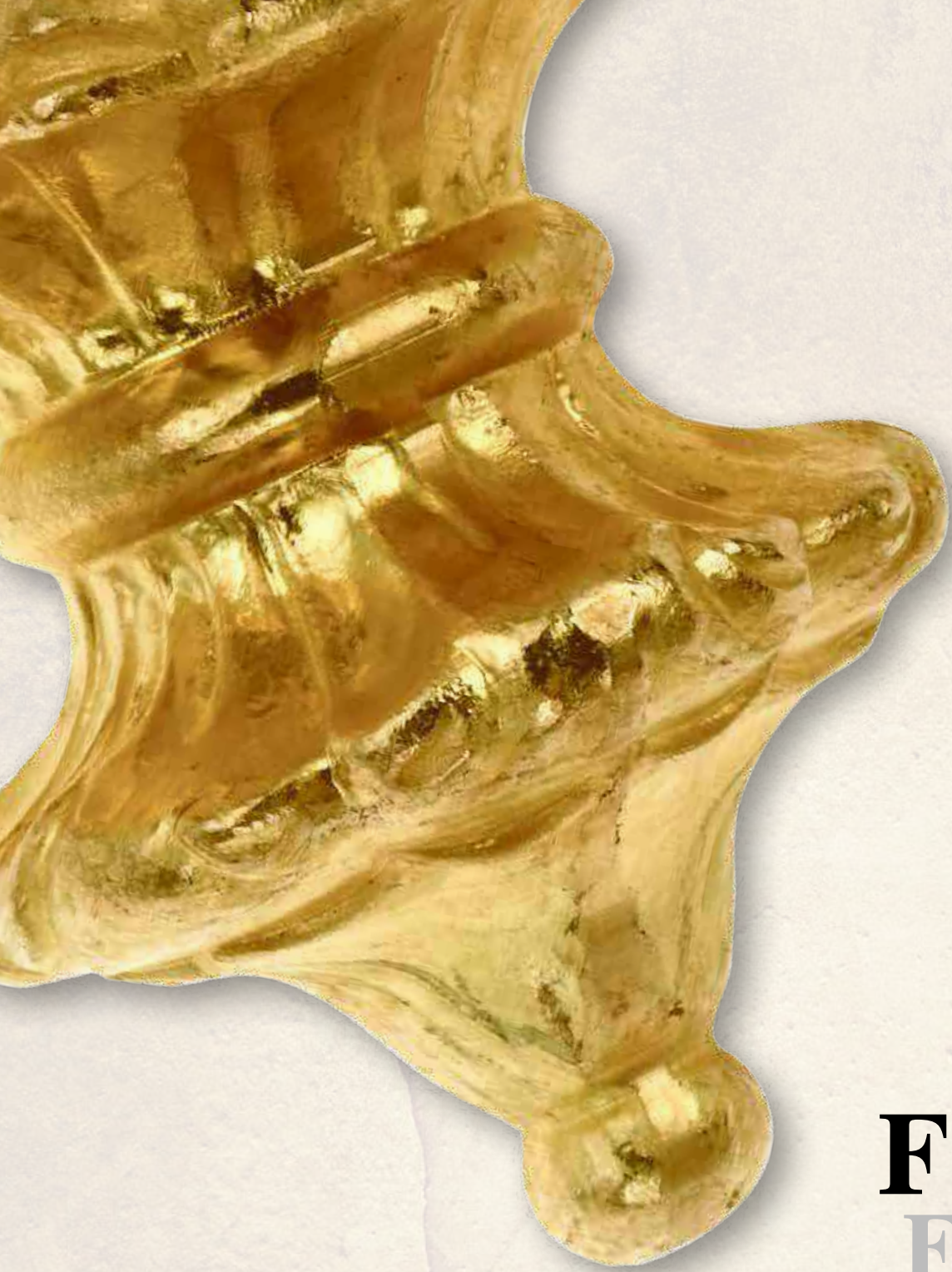

FINALI FINIALS

Lettura misure:
Measurement legenda:

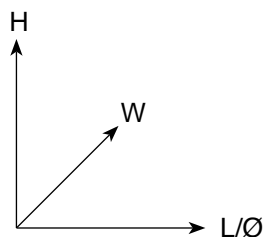
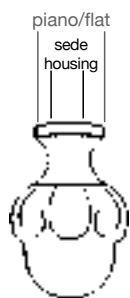

L= Lunghezza/Length
H= Altezza/Height
W= Larghezza/Width
Ø= Diametro/Diameter



21-001

L35 x W16 x H75
filetto/thread M 10/1
piano appoggio/flat support Ø14



L147

L45 x W17 x H80
filetto/thread M 10/1
piano appoggio/flat support Ø14



21-005

L75 x W18 x H85
filetto/thread M 10/1
piano appoggio/flat support Ø13



21-003

L67 x W15 x H67
filetto/thread M 10/1
piano appoggio/flat support Ø14



21-004

L60 x W15 x H60
filetto/thread M 10/1
piano appoggio/flat support Ø14



21-006

L65 x W20 x H85
filetto/thread M 10/1
piano appoggio/flat support Ø16



21-002

L50 x W16 x H53
filetto/thread M 10/1
piano appoggio/flat support Ø15



L041

Ø52 x H75
filetto/thread M 10/1
piano appoggio/flat support Ø22

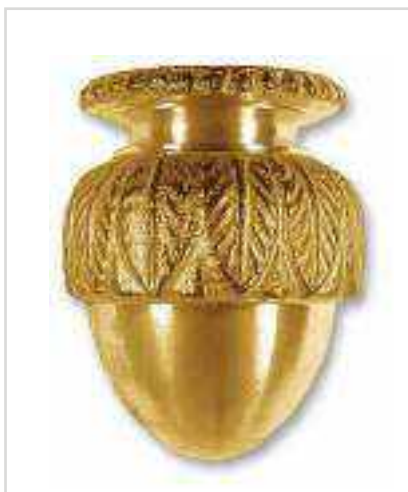

21-034

Ø32 x H44
filetto/thread M 10/1
piano appoggio/flat support Ø22

L061

Ø60 x H77
filetto/thread M 10/1
piano appoggio/flat support Ø50



21-033

Ø32 x H44
filetto/thread M 10/1
piano appoggio/flat support Ø22

L062

Ø60 x H78
filetto/thread M 10/1
piano appoggio/flat support Ø50



L044

Ø30 x H59
filetto/thread M 10/1
piano appoggio/flat support Ø21

L039

Ø42 x H85
filetto/thread M 10/1
piano appoggio/flat support Ø35



L019

Ø25 x H50
filetto/thread M 10/1
piano appoggio/flat support Ø20



L123

Ø25 x H48
filetto/thread M 10/1
piano appoggio/flat support Ø18



L060

Ø55 x H80
filetto/thread M 10/1
piano appoggio/flat support Ø41



21-035

Ø30 x H59
filetto/thread M 10/1
piano appoggio/flat support Ø35



21-017

Ø32 x H47
filetto/thread M 10/1
piano appoggio/flat support Ø19
sede interna/internal housing Ø16



L122

L36 x W32 x H56
filetto/thread M 10/1
piano appoggio/flat support Ø22



L140 - componibile con/modular with L142/L144
 Ø56,5 x H15
 filetto/thread M 10/1
 piano appoggio/flat support Ø30
 sede interna/internal housing Ø27,5



L140 - componibile con/modular with L141/L143
 Ø56,5 x H15
 filetto/thread M 10/1
 piano appoggio/flat support Ø30
 sede interna/internal housing Ø27,5



L142
 Ø60 x H34,5
 filetto/thread M 10/1
 sede interna/internal housing Ø51



L141
 Ø54,5 x H35
 filetto/thread M 10/1
 sede interna/internal housing Ø51



L144
 Ø49,5 x H38
 filetto/thread M 10/1



L143
 Ø50 x H38
 filetto/thread M 10/1



L148
 Ø43 x H55
 filetto/thread M 10/1
 piano appoggio/flat support Ø25



L065
 Ø43 x H87
 filetto/thread M 10/1
 piano appoggio/flat support Ø20



L040
 Ø40 x H80
 filetto/thread M 10/1
 piano appoggio/flat support Ø33



21-011

L23 x W30 x H38
filetto/thread M 10/1
piano appoggio/flat support Ø13

21-010

L30 x W30 x H53
filetto/thread M 10/1
piano appoggio/flat support Ø15



L113

L20 x W18 x H40
filetto/thread M 10/1
piano appoggio/flat support Ø17

L112

L35 x W32 x H55
filetto/thread M 10/1
piano appoggio/flat support Ø19



L121

Ø21 x H52
filetto/thread M 10/1
piano appoggio/flat support Ø13



L007

Ø25 x H40
filetto/thread M 10/1
piano appoggio/flat support Ø14



21-012

Ø18 x H38
filetto/thread M 10/1
piano appoggio/flat support Ø12



L003

Ø20 x H35
filetto/thread M 10/1
piano appoggio/flat support Ø15



L067

Ø37 x H40
filetto/thread M 10/1
piano appoggio/flat support Ø19

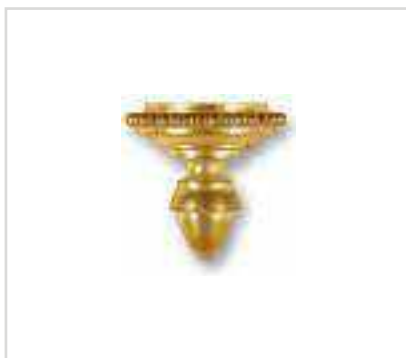

L052

Ø28 x H27
filetto/thread M 10/1
piano appoggio/flat support Ø21



21-008

Ø20 x H13
filetto/thread M 10/1
piano appoggio/flat support Ø16



L091

Ø35 x H55
filetto/thread M 10/1
piano appoggio/flat support Ø23

L066

Ø55 x H82
filetto/thread M 10/1
piano appoggio/flat support Ø38



L054

Ø30 x H40
filetto/thread M 10/1
piano appoggio/flat support Ø19

L057

Ø48 x H58
filetto/thread M 10/1
piano appoggio/flat support Ø30



L055

Ø30 x H40
filetto/thread M 10/1
piano appoggio/flat support Ø20

L056

Ø44 x H55
filetto/thread M 10/1
piano appoggio/flat support Ø30



L092

Ø50 x H48
filetto/thread M 10/1
piano appoggio/flat support Ø32

L093

Ø76 x H68
filetto/thread M 10/1
piano appoggio/flat support Ø40

L094

Ø95 x H90
filetto/thread M 10/1
piano appoggio/flat support Ø70
sede interna/internal housing Ø61



21-022

Ø20 x H23
filetto/thread M 10/1
piano appoggio/flat support Ø14

21-021

Ø35 x H41
filetto/thread M 10/1
piano appoggio/flat support Ø25
sede interna/internal housing Ø15,5

21-013

Ø50 x H62
filetto/thread M 10/1
piano appoggio/flat support Ø35
sede interna/internal housing Ø20,5



L068

Ø48 x H66
filetto/thread M 10/1
piano appoggio/flat support Ø22



L059

Ø57 x H96
filetto/thread M 10/1
piano appoggio/flat support Ø40



L085

Ø28 x H39
filetto/thread M 10/1
piano appoggio/flat support Ø20



L029

Ø30 x H70
filetto/thread M 10/1
piano appoggio/flat support Ø24

L042

Ø48 x H73
filetto/thread M 10/1
piano appoggio/flat support Ø28

L030

Ø37 x H80
filetto/thread M 10/1
piano appoggio/flat support Ø27



L120

Ø42 x H72
filetto/thread M 10/1
piano appoggio/flat support Ø25



21-018

Ø25 x H53
filetto/thread M 10/1
piano appoggio/flat support Ø18



21-016

L38 x Ø36 x H65
filetto/thread M 10/1
piano appoggio/flat support Ø25



L020

Ø37 x H50
filetto/thread M 10/1
piano appoggio/flat support Ø38
sede interna/internal housing Ø33



21-020

Ø24 x H38
filetto/thread M 10/1
piano appoggio/flat support Ø20



L125

Ø37 x H40
filetto/thread M 10/1
piano appoggio/flat support Ø20



L118
 Ø25 x H25
 filetto/thread M 10/1
 piano appoggio/flat support Ø20



L087
 Ø20 x H30
 filetto/thread M 10/1
 piano appoggio/flat support Ø14

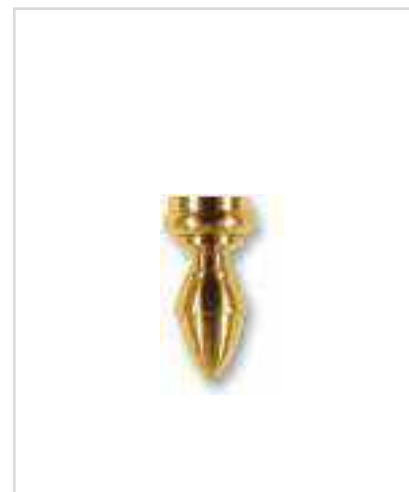

L095
 Ø14 x H24
 filetto/thread M 10/1
 piano appoggio/flat support Ø13

L117
 Ø30 x H30
 filetto/thread M 10/1
 piano appoggio/flat support Ø21

L089
 Ø29 x H38
 filetto/thread M 10/1
 piano appoggio/flat support Ø21

L096
 Ø18 x H36
 filetto/thread M 10/1
 piano appoggio/flat support Ø15



L001
 Ø20 x H35
 filetto/thread M 10/1
 piano appoggio/flat support Ø15



L086
 Ø27 x H29
 filetto/thread M 10/1
 piano appoggio/flat support Ø16



L050
 Ø28 x H40
 filetto/thread M 10/1
 piano appoggio/flat support Ø19



L053
 Ø22 x H17
 filetto/thread M 10/1
 piano appoggio/flat support Ø12



L119
 Ø20 x H16
 filetto/thread M 10/1
 piano appoggio/flat support Ø15



L101
 Ø30 x H12
 filetto/thread M 10/1
 piano appoggio/flat support Ø27
 sede interna/internal housing Ø25,5



16-016

Ø25 x H46
filetto/thread M 10/1
piano appoggio/flat support Ø18
sede interna/internal housing Ø25

16-015

Ø30 x H42
filetto/thread M 10/1
piano appoggio/flat support Ø19
sede interna/internal housing Ø16

16-014

Ø35 x H50
filetto/thread M 10/1
piano appoggio/flat support Ø22
sede interna/internal housing Ø18

16-013

Ø40 x H55
filetto/thread M 10/1
piano appoggio/flat support Ø25
sede interna/internal housing Ø22

16-012

Ø45 x H62
filetto/thread M 10/1
piano appoggio/flat support Ø26
sede interna/internal housing Ø22

16-011

Ø50 x H73
filetto/thread M 10/1
piano appoggio/flat support Ø38
sede interna/internal housing Ø36

16-010

Ø58 x H85
filetto/thread M 10/1
piano appoggio/flat support Ø38
sede interna/internal housing Ø36



16-017

Ø40 x H80
filetto/thread M 10/1
piano appoggio/flat support Ø26
sede interna/internal housing Ø22



L036

Ø37 x H73
filetto/thread M 10/1
piano appoggio/flat support Ø30

L037

Ø40 x H75
filetto/thread M 10/1
piano appoggio/flat support Ø30

L043

Ø47 x H95
filetto/thread M 10/1
piano appoggio/flat support Ø30



5230-OTT
Ø30 x H30
filetto/thread M 10/1



5280-OTT
Ø25 x H35
filetto/thread M 10/1



5290-OTT
Ø25 x H35
filetto/thread M 10/1



5201-OTT
Ø35 x H55
filetto/thread M 10/1



5415-OTT
L28 x W30 x H30
filetto/thread M 10/1

Copricentri	125	17-057	125	G020	135	G396	126	20-003-12	147	20-010-01	147
		17-057-02	125	G020-F	135	G397	126	20-004	147	20-010-02	147
17-001	137	17-058	125	G023	127	G398	126	20-004-03	147	20-010-03	147
17-002	137	17-058-02	125	G023-F	127	G399	130	20-004-04	147	20-010-04	147
17-003	137	17-060	132	G024	135	G400	130	20-004-05	147	20-010-05	147
17-004	137	17-061	132	G024-F	135	G401	130	20-004-06	147	20-010-06	147
17-007	136	17-062	132	G053	141	G402	130	20-004-08	147	20-010-30	147
17-008	136	17-064	126	G108	135	G403	129	20-004-10	147	20-010-31	147
17-009	136	17-078	137	G112	135	G404	129	20-004-12	147	20-010-32	147
17-010	136	17-079	141	G169	127	G412	131	20-004-30	147	20-010-33	147
17-011	136	17-080	141	G170	127	G413	138	20-004-36	147	20-011	147
17-012	131	17-081	141	G175	132	G414	139	20-005	147	20-011-01	147
17-013	129	17-082	141	G176	133	G416	138	20-005-02	147	20-011-02	147
17-014	129	17-083	141	G179	132	G418	138	20-005-03	147	20-011-03	147
17-015	129	17-084	137	G180	133	G420	138	20-005-04	147	20-011-04	147
17-016	133	17-085	125	G181	126	G422	139	20-005-05	147	20-011-05	147
17-017	132	17-086	127	G184	133	G426	135	20-005-06	147	20-011-06	147
17-018	133	17-087	127	G187	132	G431	139	20-005-08	147	20-012-05	148
17-019	127	17-088	127	G188	133	G450	130	20-005-10	147	20-013	146
17-020	127	17-089	125	G189	126	G462	139	20-005-12	147	J001	144
17-021	127	17-090	125	G190	132	G464	141	20-006	147	J001-05	144
17-022	127	17-091	128	G191	133	G465	141	20-006-02	147	J001-06	144
17-023	127	17-092	128	G198	130	G466	141	20-006-03	147	J001-08	144
17-024	127	17-095	132	G202	129	G467	131	20-006-04	147	J001-10	144
17-025	126	17-096	132	G217	141	G468	131	20-006-05	147	J001-12	144
17-026	126	17-097	132	G219	141	G469	131	20-006-06	147	J029	148
17-027	126	17-100	134	G220	141	G470	141	20-006-08	147	J030	148
17-028	126	17-101	134	G233	140	G471	131	20-006-10	147	J031	148
17-029	126	17-102	134	G251	127	S012	125	20-006-12	147	J032	148
17-030	126	17-103	134	G255	127	S013	125	20-006-30	147	J033	148
17-031	126	17-104	134	G300	136			20-007	147	J034	148
17-032	126	17-110	134	G305	136	Anelli	143	20-007-02	147	J035	148
17-033	128	17-111	134	G316	130			20-007-03	147	J070	148
17-034	132	17-112	134	G317	130	20-001	145	20-007-04	147	J071	148
17-035	127	17-113	134	G318	130	20-001-03	145	20-007-05	147	J071-02	148
17-036	127	17-114	134	G319	130	20-001-04	145	20-007-06	147	J071-03	148
17-037	141	17-115	134	G324	130	20-001-05	145	20-007-08	147	J072	148
17-038	141	17-116	134	G327	136	20-001-06	145	20-007-10	147	J085	145
17-039	141	17-117	134	G328	130	20-001-08	145	20-008	147	J085-05	145
17-040	141	17-118	134	G342	140	20-001-10	145	20-008-01	147	J085-06	145
17-041	141	18-061	137	G343	140	20-001-12	145	20-008-02	147	J094	148
17-042	141	18-062	137	G344	140	20-002	147	20-008-03	147	J099	148
17-043	141	G003	127	G345	140	20-002-03	147	20-008-04	147	J100	148
17-044	141	G003-F	127	G351	133	20-002-04	147	20-008-05	147	J107	144
17-045	138	G004	135	G362	136	20-002-05	147	20-008-06	147	J107-06	144
17-046	138	G004-F	135	G365	131	20-002-06	147	20-008-08	147	J107-08	144
17-047	138	G008	135	G369	128	20-002-08	147	20-008-30	147	J107-10	144
17-048	138	G008-F	135	G370	128	20-002-10	147	20-009	147	J107-12	144
17-049	139	G012	135	G371	129	20-002-12	147	20-009-01	147	J113	146
17-050	139	G012-F	135	G373	135	20-003	147	20-009-02	147	J120	143
17-051	138	G015	127	G375	140	20-003-03	147	20-009-03	147	J121	143
17-052	138	G015-F	127	G376	140	20-003-04	147	20-009-04	147	J122	143
17-053	138	G016	135	G377	131	20-003-05	147	20-009-05	147		
17-054	138	G016-F	135	G378	131	20-003-06	147	20-009-06	147		
17-055	129	G019	127	G379	131	20-003-08	147	20-009-08	147		
17-056	129	G019-F	127	G395	126	20-003-10	147	20-010	147		

COPRICENTRI E ANELLI

COVER BODIES & RINGS

Copricentri
Cover Bodies

p.125

Anelli
Rings

p.143



COPRICENTRI COVER BODIES

Lettura misure:
Measurement legenda:

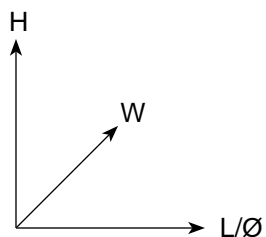
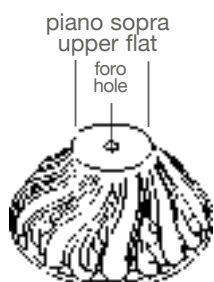

L= Lunghezza/Length
H= Altezza/Height
W= Larghezza/Width
Ø= Diametro/Diameter



17-058

Ø140 x H48 · foro/hole Ø10,5
piano sopra/upper flat Ø18

17-057

Ø200 x H70 · foro/hole Ø10,5
piano sopra/upper flat Ø24

17-089

Ø250 x H80 · foro/hole Ø10,5
piano sopra/upper flat Ø39

17-058-02

foro/hole Ø27

17-057-02

foro/hole Ø27

17-090

Ø300 x H90 · foro/hole Ø10,5
piano sopra/upper flat Ø41



17-085

Ø200 x H60 · foro/hole Ø10,5
piano sopra/upper flat Ø30



S013

Ø250 x H80
piano sopra/upper flat Ø40

S012

Ø300 x H90
piano sopra/upper flat Ø48



G181

Ø120 x H36 · foro/hole Ø10,5
piano sopra/upper flat Ø15

G189

Ø150 x H45 · foro/hole Ø10,5
piano sopra/upper flat Ø18



17-030

Ø50 x H15 · foro/hole Ø10,5
piano sopra/upper flat Ø13

17-029

Ø60 x H18 · foro/hole Ø10,5
piano sopra/upper flat Ø14

17-028

Ø80 x H24 · foro/hole Ø10,5
piano sopra/upper flat Ø20

17-027

Ø100 x H28 · foro/hole Ø10,5
piano sopra/upper flat Ø14

17-064

Ø140 x H38 · foro/hole Ø10,5
piano sopra/upper flat Ø16

17-026

Ø160 x H42 · foro/hole Ø10,5
piano sopra/upper flat Ø18

17-025

Ø200 x H50 · foro/hole Ø10,5
piano sopra/upper flat Ø20



17-032

Ø140 x H40 · foro/hole Ø10,5
piano sopra/upper flat Ø22

17-031

Ø200 x H55 · foro/hole Ø10,5
piano sopra/upper flat Ø30



G398

Ø80 x H22 · foro/hole Ø10,5
piano sopra/upper flat Ø15

G397

Ø100 x H28 · foro/hole Ø10,5
piano sopra/upper flat Ø17

G396

Ø120 x H32 · foro/hole Ø10,5
piano sopra/upper flat Ø20

G395

Ø140 x H35 · foro/hole Ø10,5
piano sopra/upper flat Ø21



17-024

Ø60 x H17 · foro/hole Ø10,5
piano sopra/upper flat Ø13

17-023

Ø80 x H20 · foro/hole Ø10,5
piano sopra/upper flat Ø13

17-022

Ø100 x H25 · foro/hole Ø10,5
piano sopra/upper flat Ø15

17-021

Ø120 x H30 · foro/hole Ø10,5
piano sopra/upper flat Ø18

17-020

Ø140 x H35 · foro/hole Ø10,5
piano sopra/upper flat Ø21

17-019

Ø160 x H40 · foro/hole Ø10,5
piano sopra/upper flat Ø21



G003

Ø50 x H11 · foro/hole Ø10,5
piano sopra/upper flat Ø13
stampato a caldo/hot pressing

G003-F

Ø50 x H11 · foro/hole Ø10,5
piano sopra/upper flat Ø13
pressofuso/die casting

17-036

Ø60 x H14 · foro/hole Ø10,5
piano sopra/upper flat Ø15

17-035

Ø70 x H16 · foro/hole Ø10,5
piano sopra/upper flat Ø14

G015

Ø80 x H17 · foro/hole Ø10,5
piano sopra/upper flat Ø16
stampato a caldo/hot pressing

G015-F

Ø80 x H17 · foro/hole Ø10,5
piano sopra/upper flat Ø16
pressofuso/die casting

G019

Ø90 x H18 · foro/hole Ø10,5
piano sopra/upper flat Ø18
stampato a caldo/hot pressing

G019-F

Ø90 x H18 · foro/hole Ø10,5
piano sopra/upper flat Ø18
pressofuso/die casting

G023

Ø100 x H19 · foro/hole Ø10,5
piano sopra/upper flat Ø18
stampato a caldo/hot pressing

G023-F

Ø100 x H19 · foro/hole Ø10,5
piano sopra/upper flat Ø18
pressofuso/die casting

G169

Ø110 x H21 · foro/hole Ø10,5
piano sopra/upper flat Ø21

G170

Ø120 x H23 · foro/hole Ø10,5
piano sopra/upper flat Ø25



17-086

Ø100 x H30 · foro/hole Ø10,5
piano sopra/upper flat Ø30

17-087

Ø140 x H40 · foro/hole Ø10,5
piano sopra/upper flat Ø30

17-088

Ø200 x H55 · foro/hole Ø10,5
piano sopra/upper flat Ø30



G251

Ø50 x H17 · foro/hole Ø10,5
piano sopra/upper flat Ø16

G255

Ø90 x H22 · foro/hole Ø10,5
piano sopra/upper flat Ø28



17-092

Ø200 x H78 · foro/hole Ø10,5
piano sopra/upper flat Ø48



G370

Ø140 x H68 · foro/hole Ø10,5
piano sopra/upper flat Ø28

G369

Ø200 x H92 · foro/hole Ø10,5
piano sopra/upper flat Ø46



17-091

Ø200 x H94 · foro/hole Ø10,5
piano sopra/upper flat Ø35



17-033

Ø160 x H65 · foro/hole Ø10,5
piano sopra/upper flat Ø55



17-015
Ø110 x H34 · foro/hole Ø10,5
piano sopra/upper flat Ø14

17-014
Ø140 x H44 · foro/hole Ø10,5
piano sopra/upper flat Ø17

17-013
Ø200 x H62 · foro/hole Ø10,5
piano sopra/upper flat Ø28



G404
Ø80 x H28 · foro/hole Ø10,5
piano sopra/upper flat Ø15

G371
Ø100 x H35 · foro/hole Ø10,5
piano sopra/upper flat Ø16

G403
Ø140 x H57 · foro/hole Ø10,5
piano sopra/upper flat Ø25



G202
Ø140 x H50 · foro/hole Ø10,5
piano sopra/upper flat Ø20



17-055
Ø80 x H34 · foro/hole Ø10,5
piano sopra/upper flat Ø17

17-056
Ø100 x H41 · foro/hole Ø10,5
piano sopra/upper flat Ø22



G316

Ø60 x H30 · foro/hole Ø10,5
piano sopra/upper flat Ø13

G317

Ø80 x H34 · foro/hole Ø10,5
piano sopra/upper flat Ø13

G318

Ø100 x H37 · foro/hole Ø10,5
piano sopra/upper flat Ø16

G319

Ø120 x H43 · foro/hole Ø10,5
piano sopra/upper flat Ø18

G324

Ø140 x H50 · foro/hole Ø10,5
piano sopra/upper flat Ø20

G328

Ø160 x H56 · foro/hole Ø10,5
piano sopra/upper flat Ø23



G402

Ø80 x H27 · foro/hole Ø10,5
piano sopra/upper flat Ø15

G401

Ø100 x H36 · foro/hole Ø10,5
piano sopra/upper flat Ø20

G400

Ø120 x H39 · foro/hole Ø10,5
piano sopra/upper flat Ø21

G399

Ø140 x H45 · foro/hole Ø10,5
piano sopra/upper flat Ø26



G198

Ø140 x H40 · foro/hole Ø10,5
piano sopra/upper flat Ø30



G450

Ø100 x H21 · foro/hole Ø10,5
piano sopra/upper flat Ø25



G379
Ø100 x H35 · foro/hole Ø10,5
piano sopra/upper flat Ø18

G378
Ø120 x H41 · foro/hole Ø10,5
piano sopra/upper flat Ø23

G377
Ø140 x H46 · foro/hole Ø10,5
piano sopra/upper flat Ø25



G412
Ø90 x H30 · foro/hole Ø10,5
piano sopra/upper flat Ø17

G365
Ø120 x H45 · foro/hole Ø10,5
piano sopra/upper flat Ø28



G467
Ø60 x H7 · foro/hole Ø10,5
piano sopra/upper flat Ø13

G468
Ø80 x H11 · foro/hole Ø10,5
piano sopra/upper flat Ø18

G469
Ø100 x H13 · foro/hole Ø10,5
piano sopra/upper flat Ø20

G471
Ø120 x H15 · foro/hole Ø10,5
piano sopra/upper flat Ø25



17-012
Ø80 x H22 · foro/hole Ø10,5
piano sopra/upper flat Ø15



G175
 Ø80 x H30 · foro/hole Ø10,5
 piano sopra/upper flat Ø12

G179
 Ø100 x H38 · foro/hole Ø10,5
 piano sopra/upper flat Ø14

17-034
 Ø110 x H41 · foro/hole Ø10,5
 piano sopra/upper flat Ø14

G187
 Ø120 x H46 · foro/hole Ø10,5
 piano sopra/upper flat Ø15

G190
 Ø140 x H52 · foro/hole Ø10,5
 piano sopra/upper flat Ø18



17-060
 Ø80 x H40 · foro/hole Ø10,5
 piano sopra/upper flat Ø13

17-061
 Ø100 x H52 · foro/hole Ø10,5
 piano sopra/upper flat Ø15

17-062
 Ø140 x H72 · foro/hole Ø10,5
 piano sopra/upper flat Ø22



17-095
 Ø116 x H38 · foro/hole Ø10,5
 piano sopra/upper flat Ø15

17-096
 Ø120 x H36 · foro/hole Ø10,5
 piano sopra/upper flat Ø18

17-097
 Ø160 x H44 · foro/hole Ø10,5
 piano sopra/upper flat Ø18



17-017
 Ø110 x H39 · foro/hole Ø10,5
 piano sopra/upper flat Ø26



G176
Ø80 x H30 · foro/hole Ø10,5
piano sopra/upper flat Ø11

G188
Ø120 x H46 · foro/hole Ø10,5
piano sopra/upper flat Ø17



17-018
Ø100 x H40 · foro/hole Ø10,5
piano sopra/upper flat Ø17

G180
Ø100 x H38 · foro/hole Ø10,5
piano sopra/upper flat Ø13

G191
Ø140 x H53 · foro/hole Ø10,5
piano sopra/upper flat Ø19

G184
Ø110 x H42 · foro/hole Ø10,5
piano sopra/upper flat Ø15



17-016
Ø100 x H42 · foro/hole Ø10,5
piano sopra/upper flat Ø15



G351
Ø70 x H22 · foro/hole Ø10,5
piano sopra/upper flat Ø24



17-100

Ø80 x H20 · foro/hole Ø10,5
piano sopra/upper flat Ø15

17-102

Ø120 x H30 · foro/hole Ø10,5
piano sopra/upper flat Ø18

17-104

Ø250 x H57 · foro/hole Ø10,5
piano sopra/upper flat Ø18

17-101

Ø100 x H25 · foro/hole Ø10,5
piano sopra/upper flat Ø18

17-103

Ø200 x H45 · foro/hole Ø10,5
piano sopra/upper flat Ø18



17-118

Ø300 x H76 foro/hole Ø10,5

17-115

Ø160 x H41 foro/hole Ø10,5

17-112

Ø100 x H26 foro/hole Ø10,5

17-117

Ø250 x H63 foro/hole Ø10,5

17-114

Ø140 x H36 foro/hole Ø10,5

17-111

Ø80 x H13 foro/hole Ø10,5

17-116

Ø200 x H50 foro/hole Ø10,5

17-113

Ø120 x H31 foro/hole Ø10,5

17-110

Ø60 x H10 foro/hole Ø10,5



G004

Ø50 x H11 · foro/hole Ø10,5
piano sopra/upper flat Ø12
stampato a caldo/hot pressing

G004-F

Ø50 x H11 · foro/hole Ø10,5
piano sopra/upper flat Ø12
pressofuso/die casting

G008

Ø60 x H13 · foro/hole Ø10,5
piano sopra/upper flat Ø13
stampato a caldo/hot pressing

G008-F

Ø60 x H13 · foro/hole Ø10,5
piano sopra/upper flat Ø13
pressofuso/die casting

G012

Ø70 x H15 · foro/hole Ø10,5
piano sopra/upper flat Ø14
stampato a caldo/hot pressing

G012-F

Ø70 x H15 · foro/hole Ø10,5
piano sopra/upper flat Ø14
pressofuso/die casting

G016

Ø80 x H17 · foro/hole Ø10,5
piano sopra/upper flat Ø14
stampato a caldo/hot pressing

G016-F

Ø80 x H17 · foro/hole Ø10,5
piano sopra/upper flat Ø14
pressofuso/die casting

G020

Ø90 x H18 · foro/hole Ø10,5
piano sopra/upper flat Ø15
stampato a caldo/hot pressing

G020-F

Ø90 x H18 · foro/hole Ø10,5
piano sopra/upper flat Ø15
pressofuso/die casting

G024

Ø100 x H20 · foro/hole Ø10,5
piano sopra/upper flat Ø14
stampato a caldo/hot pressing

G024-F

Ø100 x H20 · foro/hole Ø10,5
piano sopra/upper flat Ø14
pressofuso/die casting



G108

Ø80 x H14 · foro/hole Ø10,5
piano sopra/upper flat Ø17

G112

Ø90 x H16 · foro/hole Ø10,5
piano sopra/upper flat Ø18



G373

Ø140 x H31 · foro/hole Ø10,5
piano sopra/upper flat Ø75



G426

Ø70 x H28 · foro/hole Ø10,5
piano sopra/upper flat Ø15



17-008

Ø140 x H52 · foro/hole Ø10,5
piano sopra/upper flat Ø36

17-007

Ø200 x H74 · foro/hole Ø10,5
piano sopra/upper flat Ø50



17-009

Ø140 x H36 · foro/hole Ø10,5
piano sopra/upper flat Ø36



17-011

Ø80 x H21 · foro/hole Ø10,5
piano sopra/upper flat Ø18

17-010

Ø100 x H25 · foro/hole Ø10,5
piano sopra/upper flat Ø25



G362

Ø70 x H18 · foro/hole Ø10,5
piano sopra/upper flat Ø21

G327

Ø110 x H22 · foro/hole Ø10,5
piano sopra/upper flat Ø35

G300

Ø80 x H20 · foro/hole Ø10,5
piano sopra/upper flat Ø35

G305

Ø140 x H20 · foro/hole Ø10,5
piano sopra/upper flat Ø40



17-002

Ø140 x H60 · foro/hole Ø10,5
piano sopra/upper flat Ø37

17-001

Ø200 x H80 · foro/hole Ø10,5
piano sopra/upper flat Ø55



17-004

Ø80 x H30 · foro/hole Ø10,5
piano sopra/upper flat Ø16

17-003

Ø100 x H36 · foro/hole Ø10,5
piano sopra/upper flat Ø20



18-061

Ø80 x H24 · foro/hole Ø10,5
piano sopra/upper flat Ø13
stampato a caldo/hot pressing

18-062

Ø100 x H31 · foro/hole Ø10,5
piano sopra/upper flat Ø16
stampato a caldo/hot pressing



17-084

Ø40 x H2 · foro/hole Ø10,5
piano sopra/upper flat Ø38
tornito da barra/bar turned

17-078

Ø45 x H2,5 · foro/hole Ø10,5
tornito da barra/bar turned



17-054

Ø100 x H25 · foro/hole Ø10,5
piano sopra/upper flat Ø42

17-053

Ø120 x H30 · foro/hole Ø10,5
piano sopra/upper flat Ø38

17-052

Ø140 x H35 · foro/hole Ø10,5
piano sopra/upper flat Ø46

17-051

Ø160 x H40 · foro/hole Ø10,5
piano sopra/upper flat Ø55



G418

Ø70 x H18 · foro/hole Ø10,5
piano sopra/upper flat Ø13

G413

Ø100 x H29 · foro/hole Ø10,5
piano sopra/upper flat Ø18



17-048

Ø100 x H34 · foro/hole Ø10,5
piano sopra/upper flat Ø14

17-047

Ø120 x H42 · foro/hole Ø10,5
piano sopra/upper flat Ø16

17-046

Ø140 x H48 · foro/hole Ø10,5
piano sopra/upper flat Ø18

17-045

Ø160 x H55 · foro/hole Ø10,5
piano sopra/upper flat Ø21



G420

Ø70 x H20 · foro/hole Ø10,5
piano sopra/upper flat Ø14

G416

Ø100 x H29 · foro/hole Ø10,5
piano sopra/upper flat Ø19



G422

Ø70 x H22 · foro/hole Ø10,5
piano sopra/upper flat Ø14

G414

Ø100 x H35 · foro/hole Ø10,5
piano sopra/upper flat Ø21



17-050

Ø70 x H18 · foro/hole Ø10,5
piano sopra/upper flat Ø20

17-049

Ø90 x H21 · foro/hole Ø10,5
piano sopra/upper flat Ø16



G462

Ø120 x H43 · foro/hole Ø10,5
piano sopra/upper flat Ø30



G431

Ø132 x H49 · foro/hole Ø10,5
piano sopra/upper flat Ø38



G375

Ø100 x H30 · foro/hole Ø10,5
piano sopra/upper flat Ø30

G376

Ø150 x H45 · foro/hole Ø10,5
piano sopra/upper flat Ø45



G233

Ø140 x H33 · foro/hole Ø10,5
piano sopra/upper flat Ø30



G344

L100 x W100 x H35
foro/hole Ø10,5
piano sopra/upper flat Ø22

G342

L65 x W65 x H27
foro/hole Ø10,5
piano sopra/upper flat Ø20



G345

L100 x W100 x H35
foro/hole Ø10,5
piano sopra/upper flat Ø22

G343

L65 x W65 x H27
foro/hole Ø10,5
piano sopra/upper flat Ø20



G464 pressofuso/die casted
Ø60 x H7 · foro/hole Ø10,5
piano sopra/upper flat Ø13

G465 pressofuso/die casted
Ø80 x H11 · foro/hole Ø10,5
piano sopra/upper flat Ø15

G466 pressofuso/die casted
Ø100 x H13 · foro/hole Ø10,5
piano sopra/upper flat Ø18

G470 pressofuso/die casted
Ø120 x H15 · foro/hole Ø10,5
piano sopra/upper flat Ø23

G053 stampato a caldo/hot pressing
Ø60 x H7 · foro/hole Ø10,5
piano sopra/upper flat Ø13

G217 stampato a caldo/hot pressing
Ø80 x H11 · foro/hole Ø10,5
piano sopra/upper flat Ø15

G219 stampato a caldo/hot pressing
Ø100 x H13
foro/hole Ø10,5
piano sopra/upper flat Ø18

G220 stampato a caldo/hot pressing
Ø120 x H15 · foro/hole Ø10,5
piano sopra/upper flat Ø23



17-044 pressofuso/die casted
Ø50 x H3 · foro/hole Ø10,5

17-043 pressofuso/die casted
Ø60 x H3 · foro/hole Ø10,5

17-042 pressofuso/die casted
Ø70 x H3 · foro/hole Ø10,5

17-041 pressofuso/die casted
Ø80 x H3 · foro/hole Ø10,5

17-040 pressofuso/die casted
Ø90 x H3 · foro/hole Ø10,5

17-039 pressofuso/die casted
Ø100 x H3 · foro/hole Ø10,5

17-038 pressofuso/die casted
Ø110 x H3 · foro/hole Ø10,5

17-037 pressofuso/die casted
Ø120 x H3 · foro/hole Ø10,5

17-079 pressofuso/die casted
Ø130 x H3 · foro/hole Ø10,5

17-080 pressofuso/die casted
Ø140 x H3 · foro/hole Ø10,5

17-081 pressofuso/die casted
Ø150 x H3 · foro/hole Ø10,5

17-082 pressofuso/die casted
Ø160 x H3 · foro/hole Ø10,5

17-083 pressofuso/die casted
Ø200 x H3 · foro/hole Ø10,5



ANELLI RINGS

Lettura misure:
Measurement legenda:

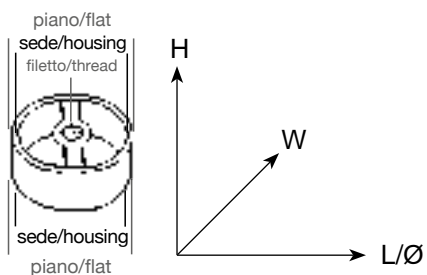

N.B. quota sedi specificata in NERO
housing dimension in BLACK

L= Lunghezza/Length
H= Altezza/Height
W= Larghezza/Width
Ø= Diametro/Diameter

Esempio Codice-Fori / Code-holes Example
Fori / Holes Ø10,5

20-001	= senza fori/whitout holes
20-001-01	= 1 foro/hole
20-001-02	= 2 fori/holes
20-001-03	= 3 fori/holes
20-001-04	= 4 fori/holes
20-001-05	= 5 fori/holes
20-001-06	= 6 fori/holes
20-001-08	= 8 fori/holes
20-001-10	= 10 fori/holes
20-001-12	= 12 fori/holes
20-001-30	= senza fori/whitout holes 3 righe/ruls
20-001-31	= 1 foro/hole 3 righe/ruls
20-001-32	= 2 fori/holes 3 righe/ruls
20-001-33	= 3 fori/holes 3 righe/ruls
20-001-36	= 6 fori/holes 3 righe/ruls

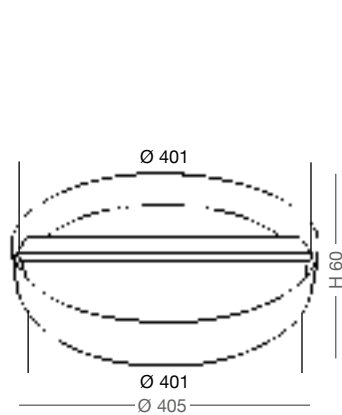

J120
Ø405 x H60

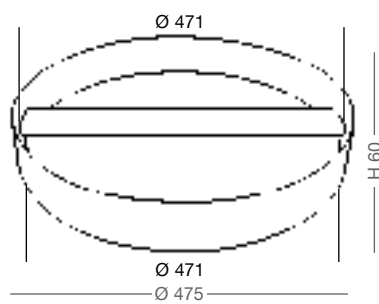

J121
Ø475 x H60

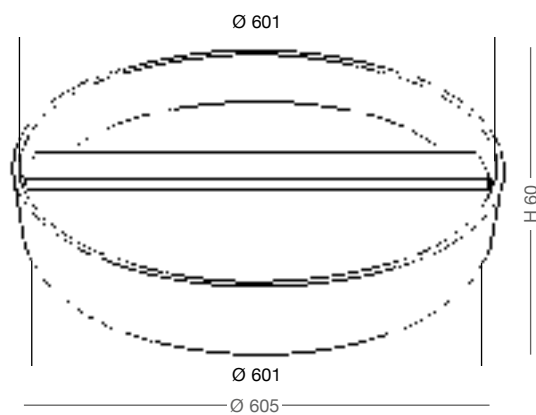

J122
Ø605 x H60

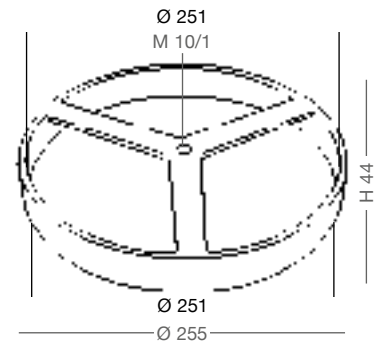

J001

Ø250 x H44

fori/holes

-05, -06, -08, -10, -12

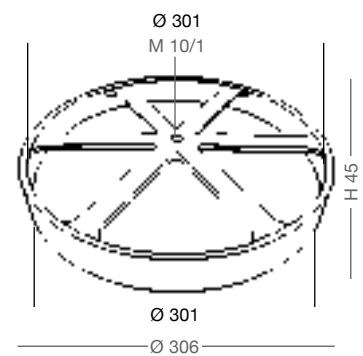

J107

Ø300 x H45

fori/holes

-06, -08, -10, -12

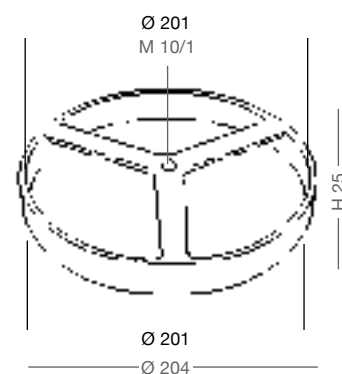

20-001

Ø200 x H25

fori/holes

-03, -04, -05, -06, -08, -10, -12

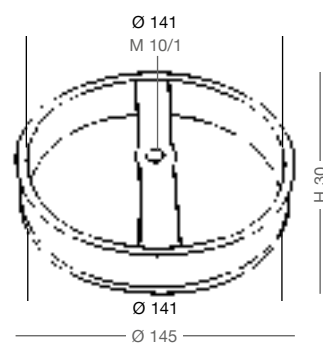

J085

Ø145 x H30

fori/holes

-05, -06

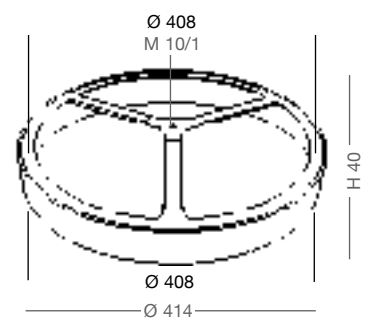

20-013
Ø414 x H40

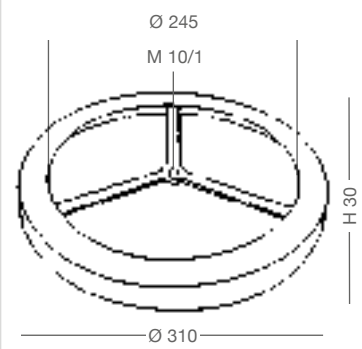

J113
Ø310 x H30

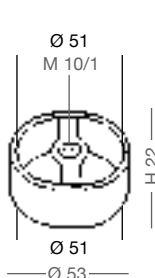

20-011
Ø50 x H22

fori/holes
-01, -02, -03,
-04, -05, -06

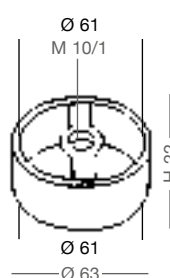

20-010
Ø60 x H22

fori/holes
-01, -02, -03, -04, -05,
-06, -30, -31, -32, -33

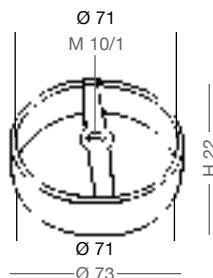

20-009
Ø70 x H22

fori/holes
-01, -02, -03, -04, -05,
-06, -08

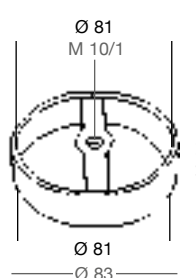

20-008
Ø80 x H22

fori/holes
-01, -02, -03, -04, -05,
-06, -08, -30

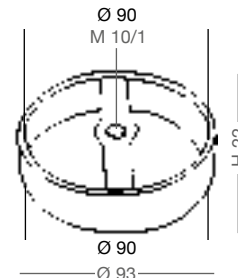

20-007
Ø90 x H22

fori/holes
-02, -03, -04, -05, -06,
-08, -10

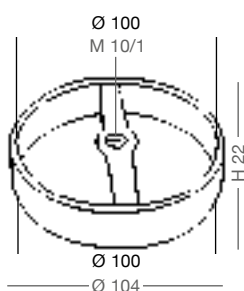

20-006
Ø100 x H22

fori/holes
-02, -03, -04, -05, -06,
-08, -10, -12, -30

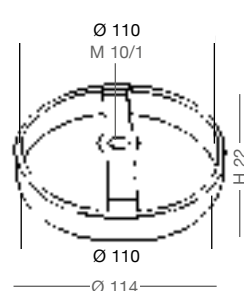

20-005
Ø110 x H22

fori/holes
-02, -03, -04, -05, -06,
-08, -10, -12

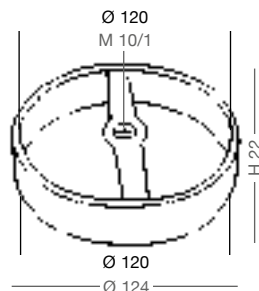

20-004
Ø120 x H22

fori/holes
-03, -04, -05, -06, -08,
-10, -12, -30, -36

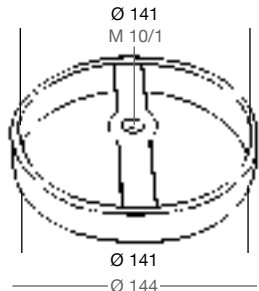

20-003
Ø140 x H24

fori/holes
-03, -04, -05, -06, -08,
-10, -12

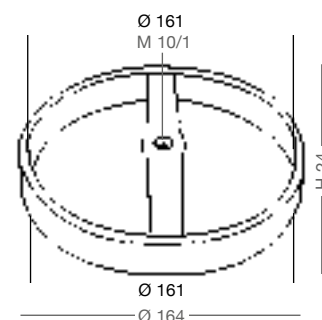

20-002
Ø160 x H24

fori/holes
-03, -04, -05, -06, -08,
-10, -12

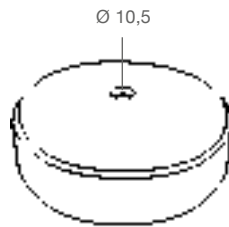

J029
Ø45 x H23

J072
Ø55 x H25

J032
Ø70 x H23

J034
Ø90 x H23

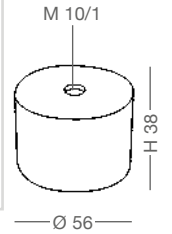

J094
Ø56 x H38

J030
Ø50 x H23

J031
Ø60 x H23

J033
Ø80 x H23

J035
Ø100 x H23

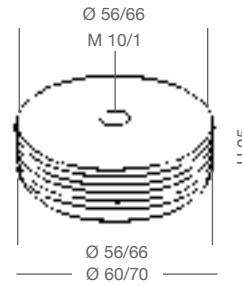

J099
Ø60 x H25

J100
Ø70 x H25

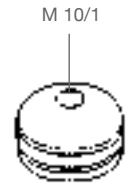

J070
Ø39 x H25

J071
Ø45 x H25

fori/holes
-02, -03

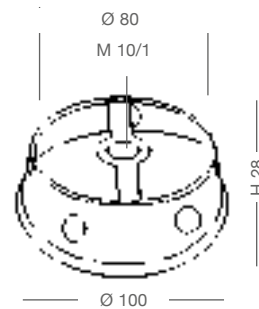

20-012-05
Ø100 x H28



Padelline	153	18-069	164	G247	158	19-007	177
		18-070	164	G253	163	19-008	176
18-001	154	18-071	164	G259	171	19-009	177
18-002	157	18-072	154	G267	158	19-010	179
18-003	154	18-073	172	G272	171	19-011	179
18-004	155	G005	172	G273	171	19-013	178
18-005	153	G006	164	G274	166	19-015	178
18-006	156	G010	164	G279	169	19-016	178
18-007	154	G013	169	G314	161	19-017	179
18-008	157	G014-F	164	G315	161	19-019	180
18-009	156	G017	170	G331	160	19-019-10	180
18-010	153	G018	164	G332	160	19-020	178
18-011	156	G021	170	G336	165	19-021	178
18-012	158	G022	164	G337	172	19-022	176
18-013	159	G026	168	G338	172	K001	175
18-014	161	G027	168	G348	172	K005	175
18-015	155	G028	169	G349	172	K006	178
18-016	155	G029	169	G352	167	K007	176
18-017	153	G034	156	G357	163	K008	175
18-018	157	G050	168	G358	163	K009	175
18-019	153	G053	170	G366	163	K016	177
18-020	154	G062	155	G367	163	K020	178
18-021	159	G074	159	G380	166	K035	177
18-022	158	G077	161	G381	166	K042	179
18-023	154	G125	168	G382	166	K044	175
18-024	159	G126	166	G385	160	K055	178
18-025	157	G131	153	G386	160	K057	175
18-026	160	G135	157	G387	159	K066	180
18-027	156	G137-F	166	G388	159	K067	180
18-030	168	G139	161	G389	167	K069	177
18-032	169	G147	155	G390	167	K070	178
18-033	169	G148	156	G393	164	K074	179
18-034	169	G151	162	G405	163	K077	179
18-035	169	G151-F	162	G408	163	K079	177
18-036	168	G154	169	G411	163	K080	179
18-037	168	G155	162	G445	155	K081	180
18-038	168	G155-F	162	G446	165	K082	180
18-039	168	G158-F	153	G447	160	K083	180
18-040	158	G159-F	162	G448	161	K084	180
18-041	160	G162-F	153	G451	160	K085	180
18-042	160	G163	162	G452	158	K086	180
18-045	170	G163-F	162	G457	167	K087	180
18-046	158	G167	162	G458	167	K088	175
18-047	158	G167-F	162	G460	171	K089	176
18-048	162	G171	162	G464	170	K090	176
18-049	166	G171-F	162	G465	170	K091	176
18-050	166	G174	170	G466	170	K092	179
18-051	171	G178	170	G470	170	K095	179
18-052	170	G182	170	G472	162	K096	180
18-053	170	G186	170	Z280	163	K102	177
18-054	167	G205	154	Z281	163	K103	175
18-055	171	G209	162			Z280	181
18-056	167	G217	170			Z281	181
18-057	167	G218	154			Z282	181
18-058	153	G219	170	Portacandele	175		
18-060	164	G220	170	19-001	176		
18-064	172	G236	161	19-002	176		
18-066	165	G237	159	19-004	176		
18-067	165	G241	171	19-005	176		
18-068	165	G244	157	19-006	175		

PADELLINE E PORTACANDELE BOBECHES & CANDLE HOLDER

Padelline
Bobeches

p.153

Portacandele
Candle holder

p.175



PADELLINE BOBECHES

Lettura misure:
Measurement legenda:



foro
hole
piano sopra
upper flat

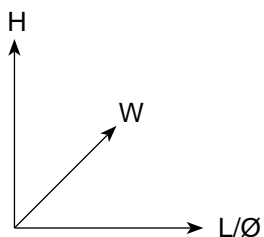

L= Lunghezza/Length
H= Altezza/Height
W= Larghezza/Width
Ø= Diametro/Diameter



G131

Ø70 x H14
foro/hole Ø10,5
piano sopra/round flat Ø30

18-005

Ø95 x H13
foro/hole Ø10,5
piano sopra/round flat Ø35



G158-F

Ø80 x H13
foro/hole Ø10,5
piano sopra/round flat Ø15
pressofuso/die casted

G162-F

Ø100 x H15
foro/hole Ø10,5
piano sopra/round flat Ø18
pressofuso/die casted



18-010

Ø95 x H12
foro/hole Ø10,5
piano sopra/round flat Ø16



18-019

Ø97 x H11
foro/hole Ø10,5
piano sopra/round flat Ø20



18-017

Ø93 x H15
foro/hole Ø10,5
piano sopra/round flat Ø15



18-058

Ø90 x H12
foro/hole Ø10,5
piano sopra/round flat Ø18



18-007

Ø90 x H5
foro/hole Ø10,5
piano sopra/round flat Ø15

18-072

Ø120 x H5
foro/hole Ø10,5
piano sopra/round flat Ø20



G205

Ø70 x H26
foro/hole Ø10,5
piano sopra/round flat Ø14

G218

Ø100 x H20
foro/hole Ø10,5
piano sopra/round flat Ø14



18-020

Ø90 x H14
foro/hole Ø10,5
piano sopra/round flat Ø12



18-003

Ø95 x H20
foro/hole Ø10,5
piano sopra/round flat Ø15



18-001

Ø90 x H14
foro/hole Ø10,5
piano sopra/round flat Ø22



18-023

Ø100 x H14
foro/hole Ø10,5
piano sopra/round flat Ø35



18-004
L75 x W75 x H10
foro/hole Ø10,5
piano sopra/round flat Ø14



18-015
Ø98 x H15
foro/hole Ø10,5
piano sopra/round flat Ø15



18-016
Ø72 x H18
foro/hole Ø10,5
piano sopra/round flat Ø14



G147
Ø67 x H11
foro/hole Ø10,5
piano sopra/round flat Ø20



G062
Ø65 x H8
foro/hole Ø10,5
piano sopra/round flat Ø22



G445
Ø66 x H30 · foro/hole Ø10,5
piano sopra/round flat Ø15



18-027
 L80 x W80 x H12
 foro/hole Ø10,5
 piano sopra/round flat Ø16



G034
 L85 x W85 x H15
 foro/hole Ø10,5
 piano sopra/round flat Ø15



G148
 L105 x W105 x H18
 foro/hole Ø10,5
 piano sopra/round flat Ø20



18-009
 L110 x W100 x H19
 foro/hole Ø10,5
 piano sopra/round flat Ø16



18-006
 L100 x W100 x H20
 foro/hole Ø10,5
 piano sopra/round flat Ø23



18-011
 L104 x W104 x H10
 foro/hole Ø10,5
 piano sopra/round flat Ø20



G244

L120 x W120 x H28
foro/hole Ø10,5
piano sopra/round flat Ø14



18-025

L90 x W90 x H18
foro/hole Ø10,5
piano sopra/round flat Ø13



18-008

L105 x W105 x H24
foro/hole Ø10,5
piano sopra/round flat Ø16



18-002

L100 x W100 x H17
foro/hole Ø10,5
piano sopra/round flat Ø18



18-018

L104 x W104 x H14
foro/hole Ø10,5
piano sopra/round flat Ø15



G135

L85 x W85 x H13
foro/hole Ø10,5
piano sopra/round flat Ø13



18-012
L90 x W90 x H21
foro/hole Ø10,5
piano sopra/round flat Ø13



G247
L100 x W100 x H15
foro/hole Ø10,5
piano sopra/round flat Ø30

G267
L110 x W110 x H10
foro/hole Ø10,5
piano sopra/round flat Ø14



18-040
L104 x W104 x H26
foro/hole Ø10,5
piano sopra/round flat Ø15



18-022
L110 x W110 x H30
foro/hole Ø10,5
piano sopra/round flat Ø20



G452
L74 x W74 x H30
foro/hole Ø10,5
piano sopra/round flat Ø16



18-047
L53 x W53 x H7
foro/hole Ø10,5
piano sopra/round flat Ø13

18-046
L80 x W80 x H10
foro/hole Ø10,5
piano sopra/round flat Ø13



18-021
L70 x W70 x H37
foro/hole Ø10,5
piano sopra/round flat Ø14



G074
L90 x W90 x H35
foro/hole Ø10,5
piano sopra/round flat Ø18



18-024
L65 x W65 x H26
foro/hole Ø10,5
piano sopra/round flat Ø15



18-013
L80 x W80 x H24
foro/hole Ø10,5
piano sopra/round flat Ø15



G237
L70 x W70 x H20
foro/hole Ø10,5
piano sopra/round flat Ø17



G388
L90 x W90 x H23
foro/hole Ø10,5
piano sopra/round flat Ø16

G387
L106 x W106 x H27
foro/hole Ø10,5
piano sopra/round flat Ø18



G331
L65 x W65 x H30
foro/hole Ø10,5
piano sopra/round flat Ø13



18-042
L80 x W80 x H29
foro/hole Ø10,5
piano sopra/round flat Ø13

G332
L100 x W100 x H45
foro/hole Ø10,5
piano sopra/round flat Ø19

18-041
L100 x W100 x H37
foro/hole Ø10,5
piano sopra/round flat Ø16



G386
Ø85 x H25
foro/hole Ø10,5
piano sopra/round flat Ø14



18-026
Ø80 x H25
foro/hole Ø10,5
piano sopra/round flat Ø16

G385
Ø110 x H35
foro/hole Ø10,5
piano sopra/round flat Ø18



G447
Ø110 x H30
foro/hole Ø10,5
piano sopra/round flat Ø20



G451
Ø90 x H28 foro/hole Ø10,5
piano sopra/round flat Ø17



G448
Ø96 x H34 foro/hole Ø10,5
piano sopra/round flat Ø26



G314
Ø60 x H30
foro/hole Ø10,5
piano sopra/round flat Ø13

G315
Ø80 x H34
foro/hole Ø10,5
piano sopra/round flat Ø13



G139
Ø92 x H21 foro/hole Ø10,5
piano sopra/round flat Ø28



18-014
Ø85 x H17
foro/hole Ø10,5
piano sopra/round flat Ø22



G236
Ø82 x H17
foro/hole Ø10,5
piano sopra/round flat Ø30



G077
Ø80 x H15
foro/hole Ø10,5
piano sopra/round flat Ø20



G151
 Ø50 x H11 · foro/hole Ø10,5
 piano sopra/round flat Ø13
 stampato - *printed*

G151-F
 Ø50 x H11 · foro/hole Ø10,5
 piano sopra/round flat Ø13
 pressofuso - *die casted*

G155
 Ø60 x H13 · foro/hole Ø10,5
 piano sopra/round flat Ø13
 stampato - *printed*

G155-F
 Ø60 x H13 · foro/hole Ø10,5
 piano sopra/round flat Ø13
 pressofuso - *die casted*

G159-F
 Ø70 x H15 · foro/hole Ø10,5
 piano sopra/round flat Ø14
 pressofuso - *die casted*

G163
 Ø80 x H17 · foro/hole Ø10,5
 piano sopra/round flat Ø16
 stampato - *printed*

G163-F
 Ø80 x H17 · foro/hole Ø10,5
 piano sopra/round flat Ø16
 pressofuso - *die casted*

G167
 Ø90 x H18 · foro/hole Ø10,5
 piano sopra/round flat Ø18
 stampato - *printed*

G167-F
 Ø90 x H18 · foro/hole Ø10,5
 piano sopra/round flat Ø18
 stampato - *printed*

G171
 Ø100 x H19 · foro/hole Ø10,5
 piano sopra/round flat Ø19
 stampato - *printed*

G171-F
 Ø100 x H19 · foro/hole Ø10,5
 piano sopra/round flat Ø19
 pressofuso - *die casted*



G209
 Ø70 x H16
 foro/hole Ø10,5
 piano sopra/round flat Ø13



18-048
 L90 x W90 x H15
 foro/hole Ø10,5
 piano sopra/round flat Ø16



G472
 L85 x W23 x H80



G367
Ø75 x H26 · foro/hole Ø10,5
piano sopra/round flat Ø19



G358
Ø75 x H14 · foro/hole Ø10,5
piano sopra/round flat Ø15

G411
Ø105 x H39 · foro/hole Ø10,5
piano sopra/round flat Ø20

G357
Ø105 x H18 · foro/hole Ø10,5
piano sopra/round flat Ø16

G366
Ø130 x H56 · foro/hole Ø10,5
piano sopra/round flat Ø24

G253
Ø130 x H21 · foro/hole Ø10,5
piano sopra/round flat Ø20



G408
Ø100 x H25 · foro/hole Ø10,5
piano sopra/round flat Ø45



G405
Ø93 x H29 · foro/hole Ø10,5
piano sopra/round flat Ø18



Z281
L80 x W80 x H40 · foro/hole Ø10,5
piano sopra/round flat Ø16



Z280
L100 x W100 x H30 · foro/hole Ø10,5
piano sopra/round flat Ø16



18-069

Ø90 x H30
foro/hole Ø10,5
piano sopra/round flat Ø14

18-070

Ø120 x H35
foro/hole Ø10,5
piano sopra/round flat Ø14

18-071

Ø140 x H40
foro/hole Ø10,5
piano sopra/round flat Ø14



G006

Ø60 x H12 · foro/hole Ø10,5
piano sopra/round flat Ø14
stampato - printed

G018

Ø90 x H20 · foro/hole Ø10,5
piano sopra/round flat Ø24
stampato - printed

G010

Ø70 x H14 · foro/hole Ø10,5
piano sopra/round flat Ø19
stampato - printed

G022

Ø110 x H22 · foro/hole Ø10,5
piano sopra/round flat Ø24
stampato - printed

G014-F

Ø80 x H17 · foro/hole Ø10,5
piano sopra/round flat Ø20
pressofuso - die casted



G393

L85 x W85 x H32
foro/hole Ø10,5
piano sopra/round flat Ø15



18-060

L82 x W82 x H31
foro/hole Ø10,5
piano sopra/round flat Ø21



18-068
Ø120 x H35
foro/hole Ø10,5
piano sopra/round flat Ø14



18-066
Ø100 x H30 foro/hole Ø10,5

18-067
Ø120 x H35 foro/hole Ø10,5



G336
Ø100 x H30 · foro/hole Ø10,5
piano sopra/round flat Ø20



G446
Ø100 x H18 · foro/hole Ø10,5
piano sopra/round flat Ø24



18-050
 Ø70 x H11 · foro/hole Ø10,5
 piano sopra/round flat Ø48

18-049
 Ø100 x H12 · foro/hole Ø10,5
 piano sopra/round flat Ø76



G382
 Ø85 x H30 · foro/hole Ø10,5
 piano sopra/round flat Ø16

G381
 Ø100 x H43 · foro/hole Ø10,5
 piano sopra/round flat Ø22



G137-F
 Ø57 x H17
 foro/hole Ø10,5
 piano sopra/round flat Ø14



G380
 Ø85 x H27 · foro/hole Ø10,5
 piano sopra/round flat Ø18



G274
 Ø100 x H20 · foro/hole Ø10,5
 piano sopra/round flat Ø22



G126
 L60 x W60 x H13
 foro/hole Ø10,5
 piano sopra/round flat Ø12



G389
Ø100 x H38 · foro/hole Ø10
piano sopra/round flat Ø20,5



G390
L98 x W86 x H35 · foro/hole Ø10,5
piano sopra/round flat Ø12



18-057
L80 x W70 x H18 · foro/hole Ø10,5
piano sopra/round flat Ø25



G458
L70 x W30 x H25 · foro/hole Ø10,5
piano sopra/round flat Ø17

18-056
L100 x W88 x H24 · foro/hole Ø10,5
piano sopra/round flat Ø30

G457
L90 x W102 x H35 · foro/hole Ø10,5
piano sopra/round flat Ø20



18-054
Ø58 x H14 · foro/hole Ø10,5
piano sopra/round flat Ø17



G352
Ø50 x H17 · foro/hole Ø10,5
piano sopra/round flat Ø15



18-030
 Ø58 x H23
 foro/hole Ø10,5
 piano sopra/round flat Ø15



G125
 Ø50 x H20
 foro/hole Ø10,5
 piano sopra/round flat Ø17



18-038
 Ø32 x H10
 foro/hole Ø10,5
 piano sopra/round flat Ø13



G050
 Ø40 x H15
 foro/hole Ø10,5
 piano sopra/round flat Ø17



G027
 Ø40 x H15
 foro/hole Ø10,5
 piano sopra/round flat Ø17



18-039
 Ø34 x H15
 foro/hole Ø10,5
 piano sopra/round flat Ø13



18-036
 Ø46 x H8
 foro/hole Ø10,5
 piano sopra/round flat Ø15



G026
 Ø35 x H10
 foro/hole Ø10,5
 piano sopra/round flat Ø14



18-037
 Ø32 x H10
 foro/hole Ø10,5
 piano sopra/round flat Ø14



G013
Ø65 x H9
foro/hole Ø10,5
piano sopra/round flat Ø15



G154
Ø65 x H12
foro/hole Ø10,5
piano sopra/round flat Ø18



18-033
Ø56 x H12
foro/hole Ø10,5
piano sopra/round flat Ø19



G029
Ø58 x H10
foro/hole Ø10,5
piano sopra/round flat Ø21



18-034
Ø58 x H5
foro/hole Ø10,5
piano sopra/round flat Ø35



18-032
L80 x W80 x H22
foro/hole Ø10,5
piano sopra/round flat Ø16



G028
L52 x W52 x H13
foro/hole Ø10,5
piano sopra/round flat Ø13



G279
Ø50 x H8 · foro/hole Ø10,5
piano sopra/round flat Ø12



18-035
Ø46 x H8
foro/hole Ø10,5
piano sopra/round flat Ø15



G017
 Ø70 x H10 · foro/hole Ø10,5
 piano sopra/round flat Ø30
 stampato a caldo/hot pressing

G021
 Ø85 x H19 · foro/hole Ø10,5
 piano sopra/round flat Ø40
 stampato a caldo/hot pressing

18-053
 Ø70 x H10 · foro/hole Ø10,5
 piano sopra/round flat Ø30
 pressofuso - die casted

18-052
 Ø85 x H19 · foro/hole Ø10,5
 piano sopra/round flat Ø40
 pressofuso - die casted



G174
 Ø60 x H12 · foro/hole Ø10,5
 piano sopra/round flat Ø14
 stampato a caldo/hot pressing

G178
 Ø70 x H14 · foro/hole Ø10,5
 piano sopra/round flat Ø14
 stampato a caldo/hot pressing

G182
 Ø80 x H17 · foro/hole Ø10,5
 piano sopra/round flat Ø17
 stampato a caldo/hot pressing

G186
 Ø90 x H20 · foro/hole Ø10,5
 piano sopra/round flat Ø17
 stampato a caldo/hot pressing



G053 stampato a caldo/hot pressing
 Ø60 x H9 · foro/hole Ø10,5
 piano sopra/round flat Ø13

G217 stampato a caldo/hot pressing
 Ø80 x H12 · foro/hole Ø10,5
 piano sopra/round flat Ø15

G219 stampato a caldo/hot pressing
 Ø100 x H16 · foro/hole Ø10,5
 piano sopra/round flat Ø16

G220 stampato a caldo/hot pressing
 Ø120 x H20 · foro/hole Ø10,5
 piano sopra/round flat Ø17

G464 pressofuso/die casted
 Ø60 x H9 · foro/hole Ø10,5
 piano sopra/round flat Ø13

G465 pressofuso/die casted
 Ø80 x H12 · foro/hole Ø10,5
 piano sopra/round flat Ø15

G466 pressofuso/die casted
 Ø100 x H16 · foro/hole Ø10,5
 piano sopra/round flat Ø16

G470 pressofuso/die casted
 Ø120 x H20 · foro/hole Ø10,5
 piano sopra/round flat Ø17



18-045
 Ø100 x H20 · foro/hole Ø10,5
 piano sopra/round flat Ø36



G241
Ø88 x H20 · foro/hole Ø10,5
piano sopra/round flat Ø17



18-051
Ø83 x H19 · foro/hole Ø10,5
piano sopra/round flat Ø25



G272
Ø70 x H20 · foro/hole Ø10,5
piano sopra/round flat Ø20



G259
Ø63 x H18 · foro/hole Ø10,5
piano sopra/round flat Ø36

G273
Ø80 x H20 · foro/hole Ø10,5
piano sopra/round flat Ø25



18-055
Ø40 x H12 · foro/hole Ø10,5
piano sopra/round flat Ø17



G460
Ø50 x H8
piano sopra/round flat Ø12



18-064

L100 x W100 x H30 · foro/hole Ø10,5



G349

L67 x W67 x H5 · foro/hole Ø10,5
piano sopra/round flat Ø58

G348

L104 x W105 x H5 · foro/hole Ø10,5
piano sopra/round flat Ø93



G337

L95 x W95 x H53
foro/hole Ø10,5
piano sopra/round flat Ø15

G338

L115 x W115 x H68
foro/hole Ø10,5
piano sopra/round flat Ø16



G005

Ø53 x H9 · foro/hole Ø10,5
piano sopra/round flat Ø13

18-073

Ø70 x H10 · foro/hole Ø10,5
piano sopra/round flat Ø16





PORTACANDELE

CANDLE HOLDER

Lettura misure:
Measurement legenda:

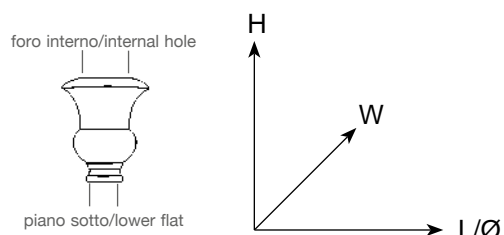

L= Lunghezza/Length
H= Altezza/Height
W= Larghezza/Width
Ø= Diametro/Diameter



K005
Ø25 x H27
filetto/thread M 10/1
piano sotto/lower flat Ø14
foro interno/internal hole Ø18



K044
Ø26 x H28
filetto/thread M 10/1
piano sotto/lower flat Ø15
foro interno/internal hole Ø19



K008
Ø30 x H35
filetto/thread M 10/1
piano sotto/lower flat Ø19
foro interno/internal hole Ø19



K103
Ø30 x H48
filetto/thread M 10/1
piano sotto/lower flat Ø15
foro interno/internal hole
Ø21,5



K057
Ø28 x H39
filetto/thread M4
piano sotto/lower flat Ø11
foro interno/internal hole Ø19,5



K001
Ø30 x H40
filetto/thread M 10/1
piano sotto/lower flat Ø18
foro interno/internal hole Ø22,5



K009
Ø30 x H40
filetto/thread M 10/1
piano sotto/lower flat Ø17
foro interno/internal hole Ø19,5



K088
Ø36 x H38
filetto/thread M 10/1
piano sotto/lower flat Ø16
foro interno/internal hole Ø27



19-006
Ø28 x H40
filetto/thread M 10/1
piano sotto/lower flat Ø15
foro interno/internal hole Ø22,5



K089

Ø38 x H40
filetto/thread M 10/1
piano sotto/lower flat Ø16
foro interno/internal hole Ø22

K090

Ø40 x H45
filetto/thread M 10/1
piano sotto/lower flat Ø16
foro interno/internal hole Ø22

K091

Ø49 x H55
filetto/thread M 10/1
piano sotto/lower flat Ø19
foro interno/internal hole Ø25



19-002

Ø45 x H38
piano sotto/lower flat Ø16
foro interno/internal hole
Ø22,5
primo foro/first hole Ø10,5

19-001

Ø56 x H50
piano sotto/lower flat Ø22
foro interno/internal hole Ø29
primo foro/first hole Ø10,5



19-005

Ø31 x H45
filetto/thread M 10/1
piano sotto/lower flat Ø17
foro interno/internal hole Ø22,5

19-004

Ø36 x H55
filetto/thread M 10/1
piano sotto/lower flat Ø19
foro interno/internal hole Ø27,5



19-008

Ø40 x H62
piano sotto/lower flat Ø18
foro interno/internal hole Ø30
primo foro/first hole Ø10,5



19-022

Ø32 x H44
filetto/ thread M 10/1



K007

Ø30 x H42
filetto/thread M 10/1
piano sotto/lower flat Ø17
foro interno/internal hole Ø19,5



K035
Ø38 x H58
filetto/thread M 10/1
piano sotto/lower flat Ø20
foro interno/internal hole Ø18



19-007
Ø33 x H76
filetto/thread M 10/1
piano sotto/lower flat Ø19
foro interno/internal hole Ø20,5



K016
Ø36 x H40
filetto/thread M 10/1
piano sotto/lower flat Ø21
foro interno/internal hole Ø31



K102
Ø37 x H42
filetto/thread M4
piano sotto/lower flat Ø22
foro interno/internal hole Ø22,5



K069
Ø48 x H60
filetto/thread M 10/1
piano sotto/lower flat Ø18
foro interno/internal hole Ø30,5



19-009
Ø28 x H50
filetto/thread M 10/1
piano sotto/lower flat Ø15
foro interno/internal hole Ø22



K079
Ø50 x H63
filetto/thread M 10/1
piano sotto/lower flat Ø30
foro interno/internal hole Ø40,5



K070

Ø48 x H60
filetto/thread M 10/1
piano sotto/lower flat Ø18
foro interno/internal hole Ø29,5



K020

Ø30 x H50
filetto/thread M 10/1
piano sotto/lower flat Ø15
foro interno/internal hole Ø21



19-016

Ø45 x H55
filetto/thread M 10/1
piano sotto/lower flat Ø16
foro interno/internal hole Ø23



19-015

Ø35 x H30
filetto/thread M 10/1
piano sotto/lower flat Ø12
foro interno/internal hole Ø29



19-021

Ø35 x H36
filetto/thread M 10/1
piano sotto/lower flat Ø16
foro interno/internal hole Ø28



K006

Ø32 x H38
filetto/thread M 10/1
piano sotto/lower flat Ø14
foro interno/internal hole Ø28



19-013

Ø30 x H40
filetto/thread M 10/1
piano sotto/lower flat Ø14
foro interno/internal hole Ø20



K055

Ø35 x H45
filetto/thread M 10/1
piano sotto/lower flat Ø18
foro interno/internal hole Ø27,5



19-020

Ø40 x H46
filetto/thread M 10/1
piano sotto/lower flat Ø16
foro interno/internal hole Ø30



19-010
Ø35 x H38
filetto/thread M 10/1
piano sotto/lower flat Ø15
foro interno/internal hole Ø23



19-011
Ø35 x H40
filetto/thread M 10/1
piano sotto/lower flat Ø12
foro interno/internal hole Ø20



K077
L40 x W44 x H48
filetto/thread M 10/1
piano sotto/lower flat Ø21
foro interno/internal hole Ø34



K080
Ø70 x H42
piano sotto/lower flat Ø17
foro interno/internal hole Ø61
primo foro/first hole Ø10,5



K074
Ø40 x H55
filetto/thread M 10/1
piano sotto/lower flat Ø25
foro interno/internal hole Ø34



K092
Ø38 x H62
filetto/thread M 10/1
piano sotto/lower flat Ø18
foro interno/internal hole Ø32



K042
Ø43 x H63
filetto/thread M 10/1
piano sotto/lower flat Ø17
foro interno/internal hole Ø26,5



19-017
Ø40 x H60
filetto/thread M 10/1
piano sotto/lower flat Ø16
foro interno/internal hole Ø27,5



K095
L54 x W54 x H74
filetto/thread M 10/1
piano sotto/lower flat Ø13
foro interno/internal hole Ø28



K084

Ø36 x H38
filetto/thread M 10/1
piano sotto/lower flat Ø15
foro interno/internal hole Ø21,5

K085

Ø40 x H45
filetto/thread M 10/1
piano sotto/lower flat Ø16
foro interno/internal hole Ø21

K086

Ø49 x H55
filetto/thread M 10/1
piano sotto/lower flat Ø19
foro interno/internal hole Ø26,5



K081

L42 x W42 x H43
filetto/thread M 10/1
piano sotto/lower flat Ø16
foro interno/internal hole Ø22,5

K082

L44 x W44 x H50
filetto/thread M 10/1
piano sotto/lower flat Ø16
foro interno/internal hole Ø22,5

K083

L52 x W52 x H62
filetto/thread M 10/1
piano sotto/lower flat Ø18
foro interno/internal hole Ø27,5



K066

Ø37 x H50
filetto/thread M 10/1
piano sotto/lower flat Ø17
foro interno/internal hole Ø21

K067

Ø54 x H70
filetto/thread M 10/1
piano sotto/lower flat Ø22
foro interno/internal hole Ø29



19-019

Ø56 x H70
filetto/thread M 10/1
piano sotto/lower flat Ø15
foro interno/internal hole Ø32



19-019-10

L26 x W26 x H10
accessorio per portacandela
candle holder accessory
piano sotto/lower flat Ø13
primo foro/first hole Ø10,5



K087

Ø32 x H75
foro interno/internal hole Ø27

K096

Ø32 x H100
foro interno/internal hole Ø27



Z282

L45 x W45 x H40

piano sotto/lower flat \varnothing 14 - foro interno/internal hole \varnothing 32 - primo foro/first hole \varnothing 10,5



Z281

L80 x W80 x H40

piano sotto/lower flat \varnothing 20 - foro interno/internal hole \varnothing 60 - primo foro/first hole \varnothing 10,5



Z280

L100 x W100 x H30

piano sotto/lower flat \varnothing 20 - foro interno/internal hole - \varnothing 55 - primo foro/first hole \varnothing 10,5



Bracci Scanalati	185	23-073	198	096-VI05	224	25-051	242	H166	254	H595	240	H836	287
		23-080	197	096-VI06	226	25-052	242	H168	254	H601	275	H838	234
22-002	187	23-081	199	096-VI06-01	226	25-053	242	H245	277	H603	262	H839	234
22-003	185	23-082	199	096-VI06-02	226	25-054	275	H246	277	H604	284	H840	263
22-004	187	23-083	199	096-VI06-03	228	25-055	265	H313	268	H615	245	H841	263
22-005	187	23-084	193	096-VI07	224	25-056	264	H316	268	H616	245	H842	263
22-006	187	H016	191	096-VI08	225	25-057	269	H379	248	H617	245	H849	234
22-007	186	H019	191	096-VI09	225	25-061	237	H381	248	H620	255	H850	263
22-008	186	H022	191	096-VI10	224	25-062	237	H382	278	H621	255	H851	289
22-011	189	H209	194	15-030	223	25-063	237	H383	278	H623	264	H852	289
22-013	189	H213	194	25-082	222	25-064	237	H386	278	H626	235	H853	289
22-014	189	H215	194	25-083	222	25-065	237	H402	275	H627	235		
22-017	188	H301	194	25-084	222	25-066	237	H414	253	H630	266		
22-018	188	H307	194	25-085	222	25-069	268	H416	253	H631	266	Bracci Riccioi Portatubo	291
22-019	205	H312	194	25-086	222	25-070	236	H417	253	H636	273		
23-007	202	H338	194	25-087	222	25-071	236	H436	241	H643	264	27-005	291
23-008	202	H431	194	26-001	223	25-072	236	H437	241	H647	247	27-006	291
23-009	196	H478	198	26-002	223	25-073	236	H438	241	H648	247	27-007	292
23-010	196	H535	190	26-010	223	25-074	231	H439	242	H649	251	27-008	292
23-011	203	H561	198	26-011	223	25-075	231	H440	242	H650	251	27-010	293
23-012	203	H593	201	26-012	223	25-076	231	H441	242	H651	266	27-011	293
23-013	202	H594	201	26-013	223	25-077	231	H453	239	H656	249	27-012	294
23-014	202	H597	196	26-020	223	25-078	231	H454	239	H659	268	27-014	294
23-015	192	H606	185	H781	220	25-079	272	H455	239	H660	270	27-017	295
23-016	192	H607	185	H782	221	25-080	233	H458	275	H668	274	27-017	295
23-017	191	H608	185	H783	220	25-081	233	H459	275	H671	285	27-046	295
23-018	191	H609	196	H784	220	25-089	262	H464	251	H672	274	27-001	296
23-019	205	H611	200	H790	221	25-081	233	H464	251	H672	274	27-002	296
23-019-10	205	H612	200	H794	219	25-089	262	H464	251	H672	274	27-003	296
23-020	205	H613	198	H795	219	25-090	235	H465	251	H677	286	27-007	292
23-020-10	205	H614	198	H796	219	25-091	235	H467	233	H678	284	27-008	292
23-021	195	H619	198	H798	219	25-092	235	H468	233	H697	269	27-010	293
23-022	195	H642	192	H799	221	25-093	232	H471	240	H713	276	27-011	293
23-023	195	H747	193			25-094	232	H472	240	H717	244	27-012	294
23-024	195	H748	193			25-095	232	H473	240	H719	281	27-032	298
23-025	195	H763	189	Bracci Tubo Interno	231	25-096	232	H474	267	H720	236	27-033	298
23-026	195	H793	201	25-001	239	25-097	256	H475	267	H721	236	27-034	298
23-027	195			25-002	239	25-098	256	H476	281	H730	285	27-035	298
23-028	195			25-003	239	25-100	255	H502	240	H731	286	27-031	299
23-029	193	Bracci Filo Esterno	207	25-004	239	25-101	255	H504	246	H732	247	27-044	299
23-030	199	24-001	212	25-008	238	25-102	254	H505	246	H733	247	27-049	299
23-031	199	24-002	212	25-009	238	25-103	254	H513	246	H734	248	27-050	299
23-032	199	24-003	213	25-010	238	25-104	260	H514	246	H735	248	27-021	300
23-034	201	24-004	213	25-011	238	25-105	260	H515	246	H739	283	27-022	300
23-035	201	24-005	207	25-012	238	25-106	261	H516	244	H740	283	27-027	300
23-036	201	24-008	209	25-013	238	25-107	261	H517	244	H741	283	27-029	300
23-038	203	24-009	214	25-014	278	25-108	257	H518	244	H744	244	27-042	301
23-039	203	24-010	208	25-015	278	25-109	257	H519	271	H753	264	27-043	301
23-040	203	24-017	211	25-016	278	25-110	257	H520	271	H754	250	27-045	301
23-041	196	24-019	217	25-017	255	25-111	257	H523	270	H755	250	D301	301
23-042	192	H356	215	25-018	255	25-112	259	H524	270	H758	244	28-016	302
23-043	192	H358	216	25-019	255	25-113	259	H528	252	H768	249	28-018	302
23-044	188	H404	210	25-020	272	25-114	258	H531	249	H777	241	28-019	302
23-045	188	H526	210	25-021	243	25-115	258	H532	249	H778	241	28-022	302
23-046	197	H527	210	25-022	243	25-116	258	H548	254	H805	286	28-024	302
23-047	197	H737	216	25-023	243	25-117	258	H549	254	H806	286	D262	302
23-048	204	H750	211	25-027	282	25-118	260	H554	245	H809	288	28-003	303
23-049	194	H802	217	25-028	282	25-119	260	H555	245	H810	287	28-010	303
23-051	197	H803	217	25-029	282	25-120	259	H556	245	H812	287	28-011	303
23-058	204			25-035	280	25-121	259	H559	250	H813	287	28-020	303
23-059	204	Bracci Componibili	219	25-036	280	25-122	259	H560	250	H814	287	28-026	303
23-063	196	096-VI01	227	25-037	279	25-123	259	H577	243	H815	234	29-132	303
23-064	196	096-VI01-01	227	25-038	279	F514	263	H578	243	H818	288	28-002	304
23-065	196	096-VI01-02	227	25-039	279	H033	268	H579	243	H819	288	28-004	304
23-068	202	096-VI01-03	229	25-040	279	H034	268	H580	243	H820	288	28-007	304
23-069	202	096-VI01-05	229	25-041	235	H040	269	H584	253	H827	234	28-008	304
23-070	202	096-VI02	224	25-042	235	H041	282	H585	253	H828	269	28-009	304
23-071	202	096-VI03	225	25-043	233	H091	269	H586	253	H829	269	28-012	304
23-072	198	096-VI04	225	25-044	233	H139	252	H587	267	H830	282		
						H146	282	H588	267	H831	254		
						H163	271	H589	267	H832	265		

BRACCI

ARMS

Bracci scanalati Grooved Arms	p.185
Bracci con filo esterno Arms with external cable	p.207
Bracci Componibili Composable Arms	p.219
Bracci con tubo interno Arms with internal tube	p.231
Bracci e Riccioli portatubo Tube holder Arms & Curls	p.291



BRACCI Scanalati

Grooved ARMS

Lettura misure:

Measurement legenda:

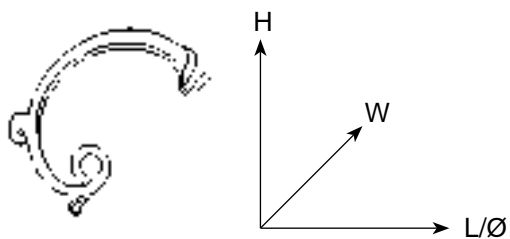

L= Lunghezza/Length

H= Altezza/Height

W= Larghezza/Width

Ø= Diametro/Diameter

Tutti gli articoli filettati M 10/1 sono disponibili con filettatura 1/8 IPS. Per identificare la filettatura 1/8 IPS è necessario aggiungere il suffisso "-01" alla fine di ogni codice articolo.

All Framon threaded articles are M10/1 type; 1/8 IPS thread version is available on customer demand. To obtain 1/8 IPS suffix "-01" must be added at the end of the article code.

Esempio - Example:

22-003 = filetto/thread M 10/1

22-003-01 = filetto/thread 1/8 IPS



H606

L110 x W20 x H110
filetto/thread M10/1

H608

L140 x W20 x H140
filetto/thread M10/1

H607

L180 x W20 x H180
filetto/thread M10/1



22-003

L140 x W18 x H160
filetto/thread M10/1



22-007
L155 x W19 x H170
filetto/thread M10/1



22-008
L150 x W20 x H170
filetto/thread M10/1



22-006
L145 x W19 x H130
filetto/thread M10/1

22-005
L175 x W19 x H175
filetto/thread M10/1



22-002
L120 x W16 x H135
filetto/thread M10/1



22-004
L140 x W15 x H120
filetto/thread M10/1



23-045

L155 x W25 x H90
filetto/thread M10/1

23-044

L220 x W42 x H100
filetto/thread M10/1



22-018

L130 x W21 x H110
filetto/thread M10/1



22-017

L165 x W18 x H110
filetto/thread M10/1



22-013
L100 x W20 x H140
filetto/thread M10/1



22-014
L105 x W19 x H135
filetto/thread M10/1



22-011
L100 x W18 x H160
filetto/thread M10/1



H763
L105 x W14 x H155
filetto/thread M10/1



H535

L160 x W25 x H290
filetto/thread M10/1



H022
L145 x W18 x H110
filetto/thread M10/1

H019
L200 x W19 x H140
filetto/thread M10/1

H016
L325 x W22 x H170
filetto/thread M10/1



23-018
L170 x W18 x H100
filetto/thread M10/1

23-017
L250 x W20 x H140
filetto/thread M10/1



23-043

L140 x W17 x H75
 filetto/thread M10/1

23-042

L210 x W20 x H120
 filetto/thread M10/1



H642

L195 x W32 x H120
 filetto/thread M10/1



23-016

L180 x W18 x H100
 filetto/thread M10/1

23-015

L240 x W22 x H140
 filetto/thread M10/1



H748
L230 x W30 x H125
filetto/thread M10/1

H747
L280 x W41 x H140
filetto/thread M10/1



23-029
L85 x W20 x H130
filetto/thread M10/1



23-084
L360 x W30 x H250
filetto/thread M10/1



H209

L125 x W16 x H65
filetto/thread M10/1

23-049

L190 x W21 x H90
filetto/thread M10/1

H213

L220 x W25 x H110
filetto/thread M10/1

H215

L310 x W28 x H120
filetto/thread M10/1



H338

L110 x W17 x H45
filetto/thread M10/1

H431

L160 x W16 x H70
filetto/thread M10/1

H307

L190 x W16 x H90
filetto/thread M10/1

H301

L235 x W17 x H110
filetto/thread M10/1

H312

L320 x W17 x H110
filetto/thread M10/1



23-028

L140 x W17 x H75
filetto/thread M10/1

23-027

L170 x W17 x H110
filetto/thread M10/1

23-026

L210 x W20 x H130
filetto/thread M10/1

23-025

L360 x W30 x H225
filetto/thread M10/1



23-024

L140 x W17 x H65
filetto/thread M10/1

23-023

L180 x W18 x H100
filetto/thread M10/1

23-022

L245 x W18 x H110
filetto/thread M10/1

23-021

L350 x W25 x H160
filetto/thread M10/1



23-010
L190 x W40 x H60
filetto/thread M10/1

23-009
L250 x W40 x H80
filetto/thread M10/1



23-065
L130 x W18 x H50
filetto/thread M10/1

23-064
L150 x W20 x H70
filetto/thread M10/1

23-063
L190 x W21 x H90
filetto/thread M10/1



H609
L120 x W16 x H60
filetto/thread M10/1

H597
L145 x W16 x H70
filetto/thread M10/1



23-041
L90 x W19 x H55
filetto/thread M10/1



23-047

L170 x W22 x H60
filetto/thread M10/1

23-046

L225 x W22 x H100
filetto/thread M10/1



23-080

L130 x W19 x H170
filetto/thread M10/1

23-051

L200 x W19 x H110
filetto/thread M10/1



23-073
L140 x W18 x H80
filetto/thread M10/1



23-072
L210 x W22 x H130
filetto/thread M10/1

H478
L150 x W22 x H75
filetto/thread M10/1



H613
L120 x W14 x H50
filetto/thread M10/1



H614
L150 x W16 x H60
filetto/thread M10/1

H619
L110 x W14 x H85
filetto/thread M10/1

H561
L145 x W13 x H115
filetto/thread M10/1



23-032
L155 x W21 x H60
filetto/thread M10/1

23-031
L220 x W31 x H90
filetto/thread M10/1

23-030
L320 x W42 x H120
filetto/thread M10/1



23-081
L170 x W18 x H70
filetto/thread M10/1
secondo filetto/second thread M10/1

23-082
L245 x W22 x H125
filetto/thread M10/1
secondo filetto/second thread M10/1

23-083
L300 x W24 x H210
filetto/thread M10/1
secondo filetto/second thread M10/1



H611
L200 x W20 x H130
filetto/thread M10/1



H612
L130 x W20 x H100
filetto/thread M10/1



23-036

L150 x W15 x H120
filetto/thread M10/1

23-035

L200 x W18 x H160
filetto/thread M10/1

23-034

L300 x W25 x H240
filetto/thread M10/1



H593

L120 x W15 x H60
filetto/thread M10/1

H594

L160 x W19 x H95
filetto/thread M10/1



H793

L140 x W23 x H25
filetto/thread M10/1



23-071
L155 x W18 x H110
filetto/thread M10/1

23-070
L220 x W20 x H180
filetto/thread M10/1



23-014
L155 x W18 x H115
filetto/thread M10/1

23-013
L240 x W19 x H180
filetto/thread M10/1



23-008
L150 x W17 x H90
filetto/thread M10/1

23-007
L240 x W24 x H150
filetto/thread M10/1



23-069
L165 x W18 x H85
filetto/thread M10/1

23-068
L205 x W22 x H100
filetto/thread M10/1



23-040

L155 x W20 x H120
filetto/thread M10/1

23-039

L205 x W20 x H140
filetto/thread M10/1

23-038

L300 x W27 x H200
filetto/thread M10/1



23-012

L180 x W21 x H160
filetto/thread M10/1

23-011

L250 x W28 x H240
filetto/thread M10/1



23-059
L160 x W20 x H130
filetto/thread M10/1

23-058
L230 x W17 x H200
filetto/thread M10/1



23-048
L190 x W17 x H155
filetto/thread M10/1

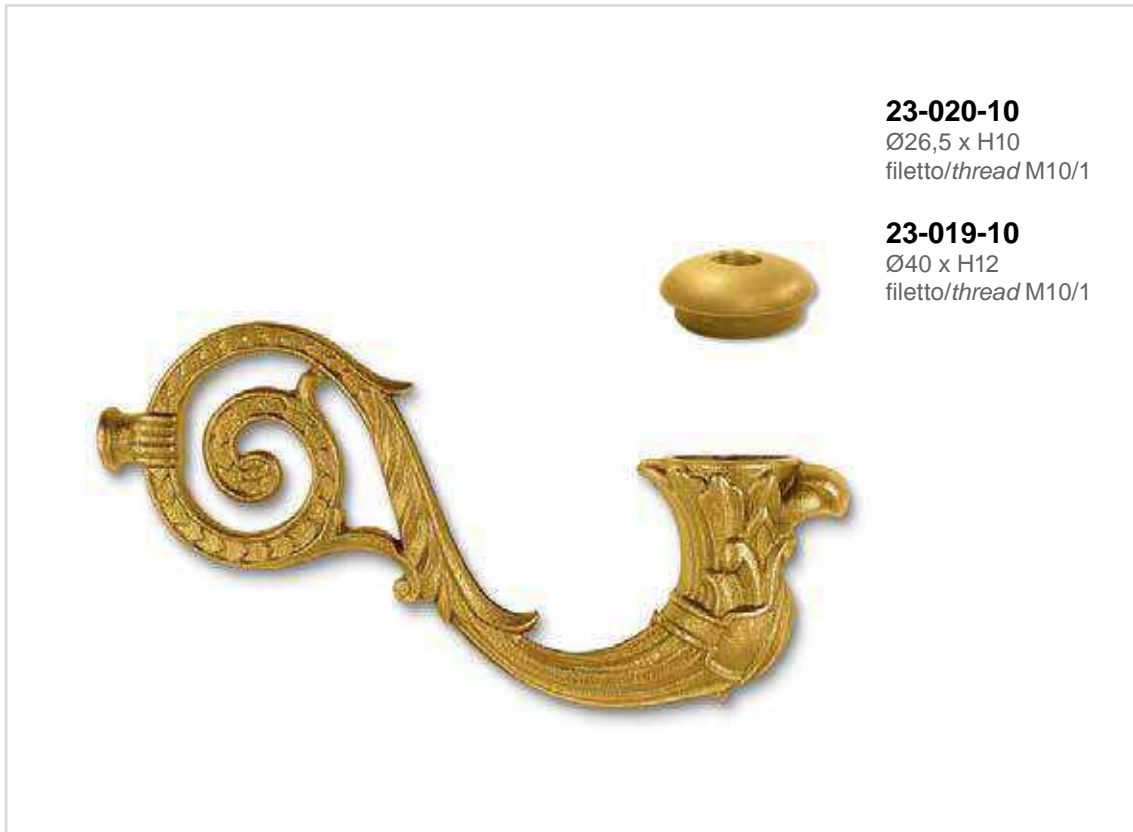

23-020-10
Ø26,5 x H10
filetto/thread M10/1

23-019-10
Ø40 x H12
filetto/thread M10/1

23-020
L155 x W28 x H80
filetto/thread M10/1

23-019
L230 x W42 x H120
filetto/thread M10/1



22-019
L260 x W26 x H200
filetto/thread M10/1



BRACCI con filo esterno

ARMS with external cable

Letture misure:

Measurement legenda:

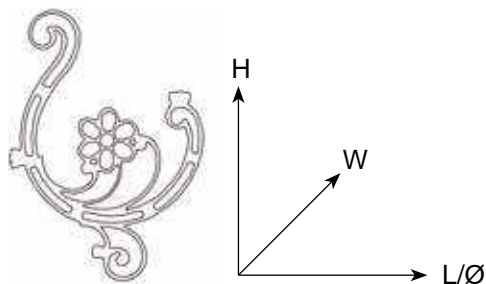

L= Lunghezza/Length

H= Altezza/Height

W= Larghezza/Width

Ø= Diametro/Diameter

Tutti gli articoli filettati M 10/1 sono disponibili con filettatura 1/8 IPS. Per identificare la filettatura 1/8 IPS è necessario aggiungere il suffisso "-01" alla fine di ogni codice articolo.

All Framon threaded articles are M10/1 type; 1/8 IPS thread version is available on customer demand. To obtain 1/8 IPS suffix "-01" must be added at the end of the article code.

Esempio - Example:

24-005 = filetto/thread M 10/1

24-005-01 = filetto/thread 1/8 IPS



24-005

L210 x W21 x H430
filetto/thread M10/1



24-010

L195 x W24 x H320
filetto/thread M10/1



24-008

L180 x W19 x H245
filetto/thread M10/1



H526
L75 x W15 x H160

H527
L130 x W15 x H285



H404
L240 x W18 x H170
filetto/thread M10/1



H750
L190 x W16 x H190
filetto/thread M10/1



24-017
L145 x W18 x H175
filetto/thread M10/1



24-002
L175 x W19 x H350
filetto/thread M10/1

24-001
L230 x W19 x H470
filetto/thread M10/1



24-004
L175 x W19 x H250
filetto/thread M10/1

24-003
L230 x W19 x H350
filetto/thread M10/1



24-009

L150 x W18 x H250
filetto/thread M10/1



H356

L250 x W23 x H330
filetto/thread M10/1



H737
L110 x W12 x H330
filetto/thread M10/1



H358
L200 x W18 x H390
filetto/thread M10/1



24-019
L190 x W21 x H250
filetto/thread M10/1



H803
L130 x W15 x H90
filetto/thread M10/1

H802
L230 x W20 x H160
filetto/thread M10/1



BRACCI Componibili

Composable ARMS

Lettura misure:

Measurement legenda:

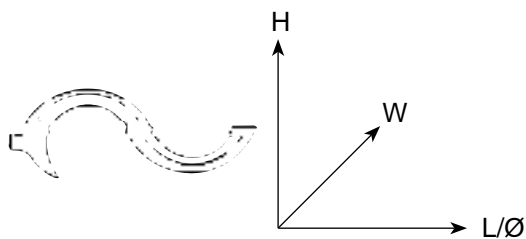

L= Lunghezza/Length

H= Altezza/Height

W= Larghezza/Width

Ø= Diametro/Diameter

Tutti gli articoli filettati M 10/1 sono disponibili con filettatura 1/8 IPS. Per identificare la filettatura 1/8 IPS è necessario aggiungere il suffisso "-01" alla fine di ogni codice articolo.

All Framon threaded articles are M10/1 type; 1/8 IPS thread version is available on customer demand. To obtain 1/8 IPS suffix "-01" must be added at the end of the article code.

Esempio - Example:

H794 = filetto/thread M 10/1

H794-01 = filetto/thread 1/8 IPS



H794
L225 x W49 x H55



H795
L155 x W44 x H55



H798
L165 x W46 x H55



H796
L165 x W45 x H60



H781
L280 x W42 x H55



H783
L310 x W35 x H70



H784
L270 x W65 x H65



H782
L175 x W29 x H30



H790
L200 x W32 x H55



H799
L220 x W40 x H90



Kit completo non montato - Complete Kit not assembled

25-082

L190 x W35 x H120

25-083

L255 x W35 x H140

25-084

L330 x W35 x H160



Kit completo non montato - Complete Kit not assembled

25-085

L330 x W35 x H120

25-086

L450 x W35 x H140

25-087

L580 x W35 x H160



26-020
L35 x W70 x H70



15-030
L35 x W35 x H10



26-002
L160 x W5 x H45
2 pezzi per telaio
2 pcs for frame

26-011
L220 x W5 x H45
2 pezzi per telaio
2 pcs for frame

26-013
L320 x W5 x H45
2 pezzi per telaio
2 pcs for frame



26-001
L170 x W30 x H50

26-010
L230 x W30 x H70

26-012
L330 x W30 x H70



096-VI07

L25 x W25 x H20
 Blocchetto per 096-VI10
Cube for 096-VI10

096-VI02

L31 x W31 x H20
 Blocchetto per 096-VI05
Cube for 096-VI05



096-VI10

L166 x W25 x H63
 Telaio per braccio piccolo
Frame for small arm

096-VI05

L200 x W31 x H75
 Telaio per braccio grande
Frame for large arm



096-VI08

L155 x W3 x H53

Inserto sinistro per telaio 096-VI10

Left-insert for frame 096-VI10

096-VI03

L190 x W3 x H65

Inserto sinistro per telaio 096-VI05

Left-insert for frame 096-VI05

096-VI09

L155 x W3 x H53

Inserto destro per telaio 096-VI10

Right-insert for frame 096-VI10

096-VI04

L190 x W3 x H65

Inserto destro per telaio 096-VI05

Right-insert for frame 096-VI05



Immagine braccio con inserto montato - *Picture assembled arm with insert*

misura piccola / small measure
096-VI10 + 096-VI08 + 096-VI09

misura grande / large measure
096-VI05 + 096-VI03 + 096-VI04



096-VI06

L120 x W17 x H65
filetto/ thread M10/1

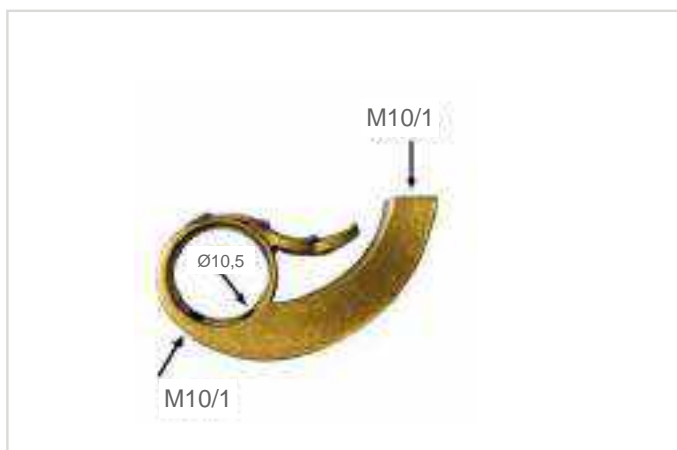

096-VI06-01

L120 x W17 x H65
Componente per braccio "S"
Component for "S" arm

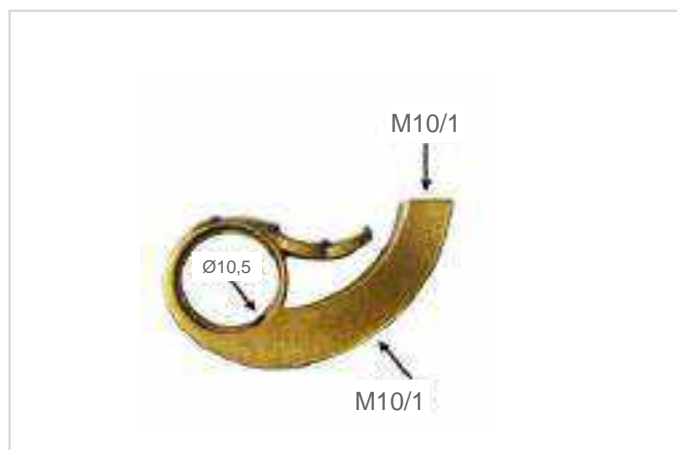

096-VI06-02

L120 x W17 x H65
Componente per braccio "C"
Component for "C" arm

Esempio di utilizzo *Use Example*

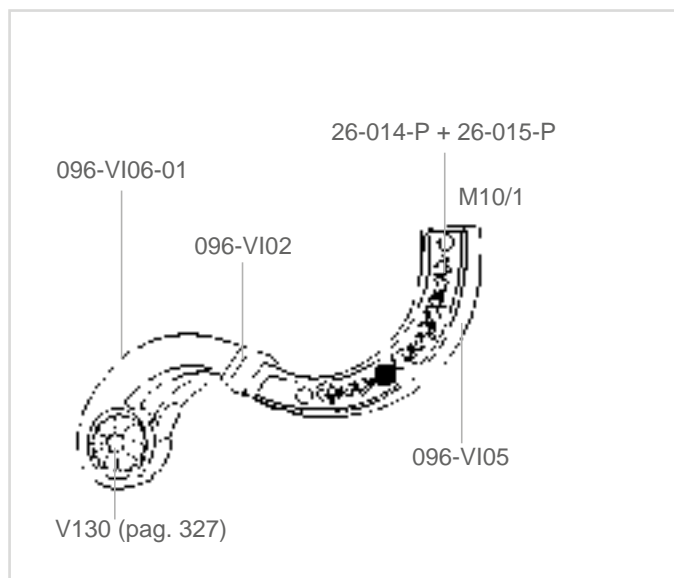

Esempio di utilizzo *Use Example*

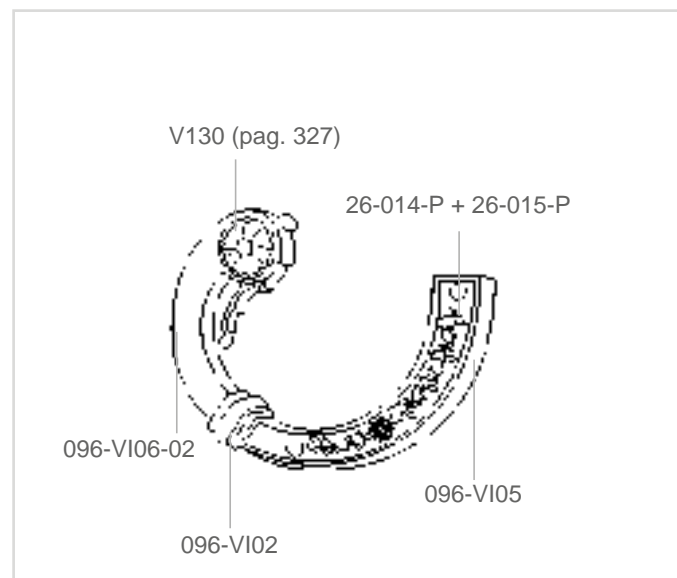



096-VI01

L143 x W20 x H65
filetto/ thread M10/1



096-VI01-01

L143 x W20 x H65
Componente per braccio "S"
Component for "S" arm

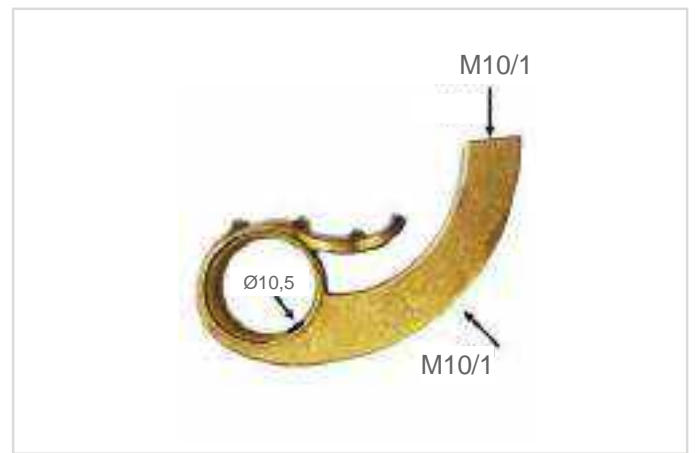

096-VI01-02

L143 x W20 x H65
Componente per braccio "C"
Component for "C" arm

Esempio di utilizzo *Use Example*

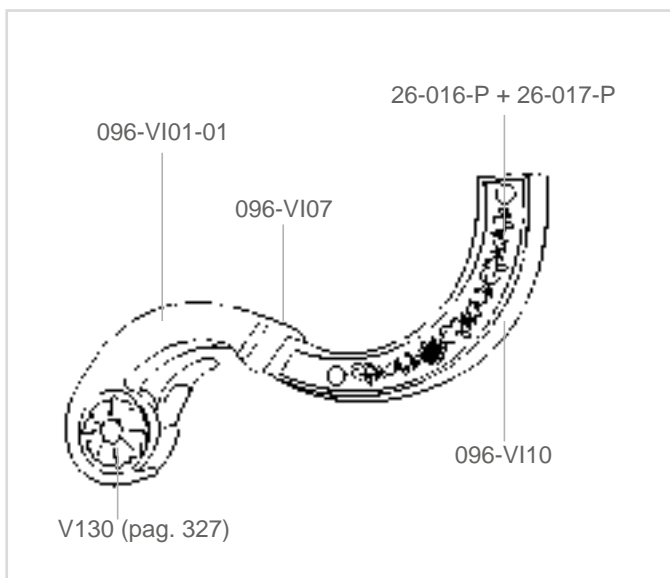

Esempio di utilizzo *Use Example*

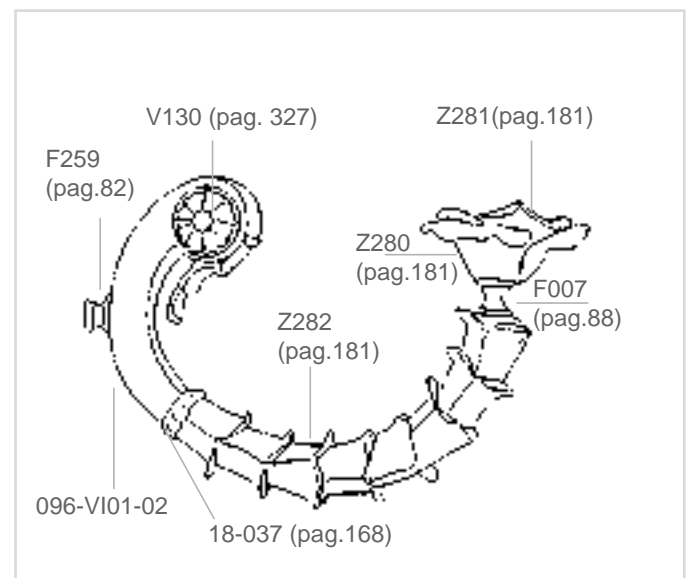

Esempio di utilizzo *Use Example*



096-VI06-03

L120 x W17 x H65
 Componente per applique
 Component for wall lantern

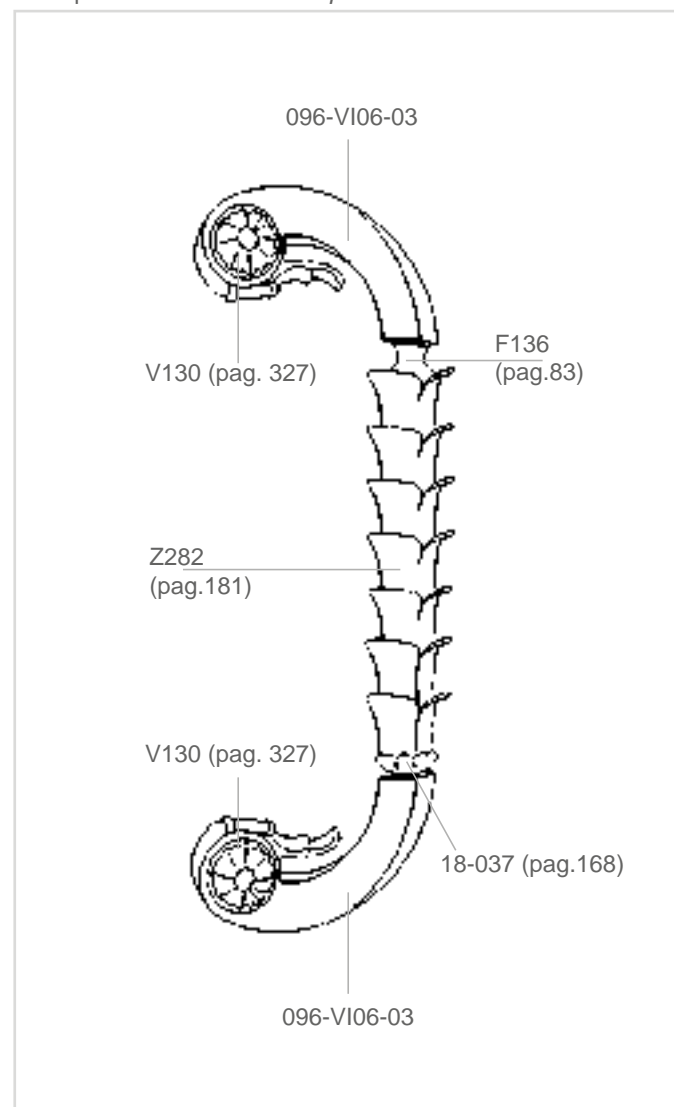

Esempio di utilizzo *Use Example*



096-VI01-03

L143 x W20 x H65
Componente per applique
Component for wall lantern

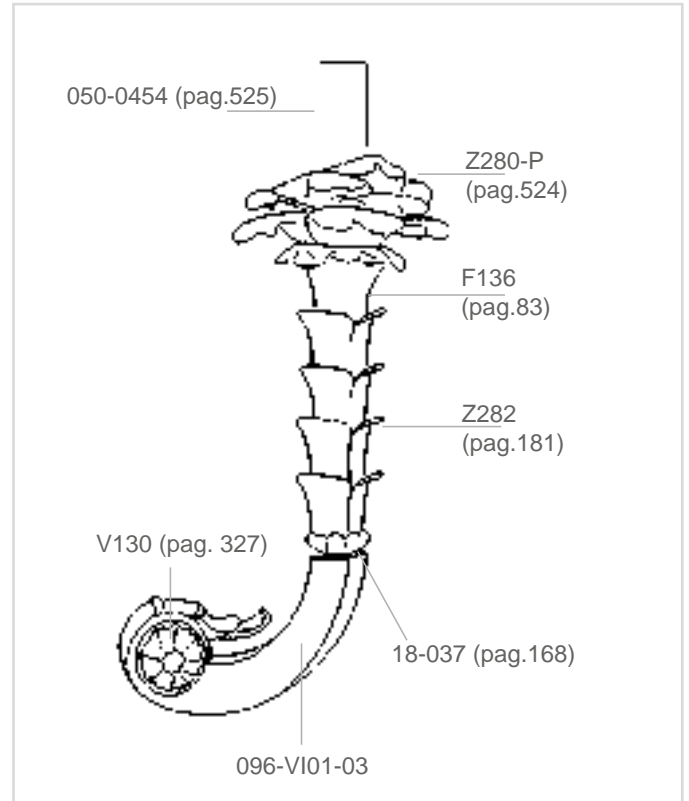

Esempio di utilizzo *Use Example*

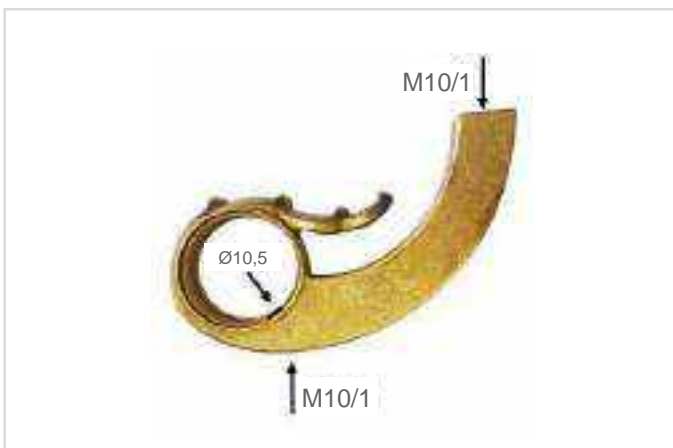

096-VI01-05

L143 x W20 x H65
Componente per braccio grande mod. Prestige
Component for large arm Prestige model

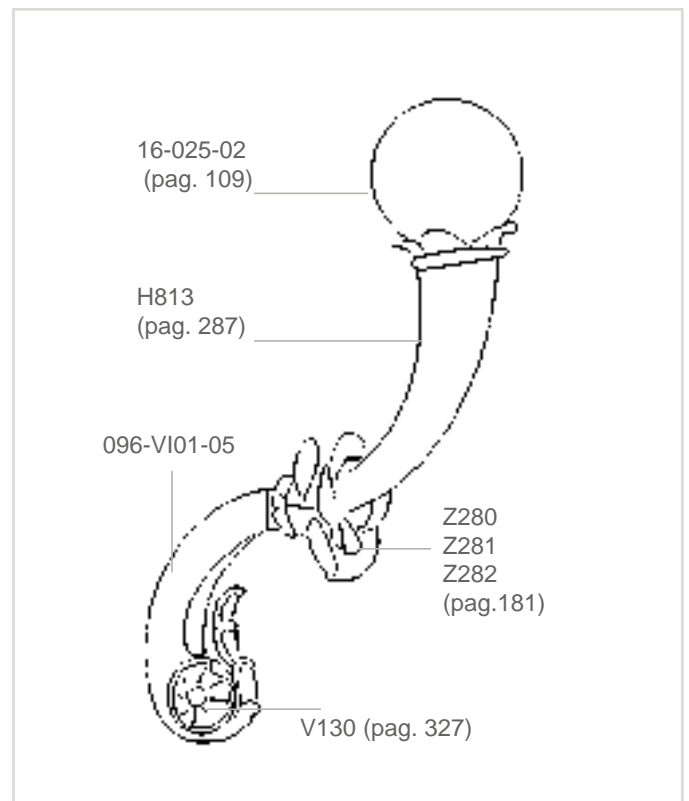



BRACCI con tubo interno

ARMS with internal tube

Lettura misure:

Measurement legenda:

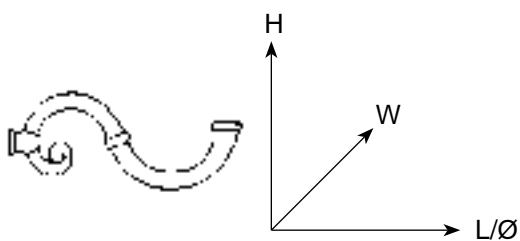

L= Lunghezza/Length

H= Altezza/Height

W= Larghezza/Width

Ø= Diametro/Diameter

Tutti gli articoli filettati M 10/1 sono disponibili con filettatura 1/8 IPS. Per identificare la filettatura 1/8 IPS è necessario aggiungere il suffisso "-01" alla fine di ogni codice articolo.

All Framon threaded articles are M10/1 type; 1/8 IPS thread version is available on customer demand. To obtain 1/8 IPS suffix "-01" must be added at the end of the article code.

Esempio - Example:

25-074 = filetto/thread M 10/1

25-074-01 = filetto/thread 1/8 IPS



25-077
25-078
1/4 gas

25-074
L140 x W26 x H120
filetto/thread M10/1

25-075
L225 x W32 x H180
filetto/thread M10/1

25-076
L325 x W25 x H220
filetto/thread M10/1

25-077
L430 x W42 x H300
filetto/thread M10/1
filetto/thread 1/4 gas

25-078
L590 x W35 x H380
filetto/thread M10/1
filetto/thread 1/4 gas



25-096
1/4 gas

25-093
L155 x W20 x H130
filetto/thread M10/1

25-094
L190 x W23 x H175
filetto/thread M10/1

25-095
L250 x W25 x H240
filetto/thread M10/1

25-096
L370 x W30 x H300
filetto/thread M10/1
filetto/thread 1/4 gas



25-044
L125 x W24 x H130
filetto/thread M10/1

25-043
L170 x W31 x H190
filetto/thread M10/1

25-080
L230 x W40 x H250
filetto/thread M10/1

25-081
L280 x W40 x H300
filetto/thread M10/1



H467
L130 x W20 x H55
filetto/thread M10/1

H468
L230 x W20 x H95
filetto/thread M10/1



H827

L120 x W19 x H90
 filetto/thread M10/1

H815

L160 x W22 x H130
 filetto/thread M10/1

H849

L200 x W25 x H175
 filetto/thread M10/1

H839

L300 x W45 x H245
 filetto/thread M10/1



H838

L180 x W28 x H130
 filetto/thread M10/1



25-092
1/4 gas

25-042
L130 x W24 x H130
filetto/thread M10/1

25-041
L170 x W25 x H170
filetto/thread M10/1

25-090
L250 x W30 x H220
filetto/thread M10/1

25-091
L315 x W33 x H280
filetto/thread M10/1

25-092
L420 x W35 x H280
filetto/thread M10/1
filetto/thread 1/4 gas



H627
L145 x W23 x H160
filetto/thread M10/1

H626
L170 x W27 x H180
filetto/thread M10/1



25-072

L165 x W22 x H55
filetto/thread M10/1

25-071

L215 x W22 x H70
filetto/thread M10/1

25-070

L290 x W22 x H80
filetto/thread M10/1

25-073

L360 x W26 x H90
filetto/thread M10/1



H720

L170 x W15 x H70
filetto/thread M10/1

H721

L280 x W15 x H120
filetto/thread M10/1



25-066
L155 x W26 x H135
filetto/thread M10/1

25-065
L205 x W30 x H165
filetto/thread M10/1

25-064
L280 x W35 x H240
filetto/thread M10/1



25-063
L140 x W34 x H75
filetto/thread M10/1

25-062
L210 x W36 x H95
filetto/thread M10/1

25-061
L290 x W36 x H140
filetto/thread M10/1



25-010

L155 x W26 x H85
filetto/thread M10/1

25-009

L200 x W26 x H100
filetto/thread M10/1

25-008

L280 x W28 x H150
filetto/thread M10/1



25-013

L150 x W29 x H75
filetto/thread M10/1

25-012

L200 x W29 x H95
filetto/thread M10/1

25-011

L260 x W35 x H145
filetto/thread M10/1



25-004
L125 x W18 x H90
filetto/thread M10/1

25-003
L170 x W19 x H120
filetto/thread M10/1

25-002
L230 x W21 x H140
filetto/thread M10/1

25-001
L295 x W25 x H190
filetto/thread M10/1



H455
L150 x W19 x H70
filetto/thread M10/1

H453
L240 x W23 x H120
filetto/thread M10/1

H454
L310 x W28 x H155
filetto/thread M10/1



H472

L165 x W18 x H75
filetto/thread M10/1

H473

L225 x W19 x H100
filetto/thread M10/1

H471

L270 x W19 x H125
filetto/thread M10/1



H595

L200 x W20 x H120
filetto/thread M10/1

H502

L290 x W20 x H245
filetto/thread M10/1



H778
L250 x W30 x H160
filetto/thread M10/1

H777
L380 x W40 x H220
filetto/thread M10/1



H438
L150 x W19 x H90
filetto/thread M10/1

H437
L220 x W21 x H130
filetto/thread M10/1

H436
L290 x W23 x H170
filetto/thread M10/1



H439
L140 x W16 x H75
filetto/thread M10/1

H441
L205 x W18 x H85
filetto/thread M10/1

H440
L290 x W20 x H115
filetto/thread M10/1



25-053
L135 x W23 x H60
filetto/thread M10/1

25-052
L190 x W24 x H70
filetto/thread M10/1

25-051
L225 x W26 x H90
filetto/thread M10/1



25-023

L125 x W19 x H60
filetto/thread M10/1

25-022

L225 x W25 x H100
filetto/thread M10/1

25-021

L300 x W31 x H120
filetto/thread M10/1



H577

L150 x W28 x H55
filetto/thread M10/1

H578

L200 x W33 x H70
filetto/thread M10/1

H579

L270 x W36 x H90
filetto/thread M10/1

H580

L335 x W46 x H125
filetto/thread M10/1



H717

L260 x W31 x H180
filetto/thread M10/1

H744

L310 x W33 x H170
filetto/thread M10/1

H758

L440 x W38 x H188
filetto/thread M10/1



H517

L175 x W28 x H95
filetto/thread M10/1

H518

L250 x W32 x H135
filetto/thread M10/1

H516

L300 x W34 x H170
filetto/thread M10/1



H615
L170 x W26 x H90
filetto/thread M10/1

H616
L260 x W32 x H135
filetto/thread M10/1

H617
L335 x W38 x H185
filetto/thread M10/1



H554
L140 x W20 x H85
filetto/thread M10/1

H555
L205 x W25 x H125
filetto/thread M10/1

H556
L280 x W26 x H160
filetto/thread M10/1



H514
L175 x W31 x H95
filetto/thread M10/1

H515
L250 x W34 x H135
filetto/thread M10/1

H513
L300 x W37 x H170
filetto/thread M10/1



H504
L160 x W17 x H50
filetto/thread M10/1

H505
L280 x W21 x H75
filetto/thread M10/1



H733
L240 x W31 x H100
filetto/thread M10/1

H732
L305 x W27 x H115
filetto/thread M10/1



H648
L145 x W22 x H65
filetto/thread M10/1

H647
L235 x W31 x H105
filetto/thread M10/1



H735
L150 x W21 x H60
filetto/thread M10/1

H734
L240 x W22 x H90
filetto/thread M10/1



H379
L140 x W22 x H70
filetto/thread M10/1

H381
L220 x W27 x H100
filetto/thread M10/1



H656

L155 x W20 x H100
filetto/thread M10/1

H768

L210 x W26 x H120
filetto/thread M10/1



H531

L150 x W20 x H80
filetto/thread M10/1

H532

L230 x W25 x H140
filetto/thread M10/1



H559
L145 x W20 x H70
filetto/thread M10/1

H560
L190 x W20 x H90
filetto/thread M10/1



H755
L150 x W21 x H70
filetto/thread M10/1

H754
L220 x W23 x H110
filetto/thread M10/1



H464
L145 x W17 x H55
filetto/thread M10/1

H465
L235 x W22 x H110
filetto/thread M10/1



H650
L135 x W20 x H50
filetto/thread M10/1

H649
L210 x W25 x H100
filetto/thread M10/1



H139

L315 x W52 x H165
filetto/thread M10/1



H528

L280 x W22 x H135
filetto/thread M10/1



H414
L140 x W20 x H40
filetto/thread M10/1

H416
L235 x W26 x H60
filetto/thread M10/1

H417
L300 x W30 x H75
filetto/thread M10/1



H584
L150 x W19 x H60
filetto/thread M10/1

H585
L225 x W22 x H80
filetto/thread M10/1

H586
L300 x W24 x H125
filetto/thread M10/1



25-103

L150 x W18 x H62
filetto/thread M10/1

25-102

L195 x W20 x H82
filetto/thread M10/1

H831

L235 x W20 x H110
filetto/thread M10/1

H166

L315 x W29 x H145
filetto/thread M10/1

H168

L400 x W34 x H180
filetto/thread M10/1



H548

L150 x W23 x H90
filetto/thread M10/1

H549

L265 x W26 x H160
filetto/thread M10/1



1/4 gas

M10/1

25-019

L155 x W20 x H100
 filetto/thread M10/1

25-101

L220 x W22 x H155
 filetto/thread M10/1

25-018

L270 x W24 x H180
 filetto/thread M10/1

25-017

L330 x W24 x H240
 filetto/thread M10/1

25-100

L405 x W26 x H300
 filetto/thread M10/1
 filetto/thread 1/4 gas



H621

L160 x W19 x H80
 filetto/thread M10/1

H620

L250 x W24 x H130
 filetto/thread M10/1



25-098
L360 x W28 x H130
filetto/thread M10/1
filetto/thread 3/8 gas

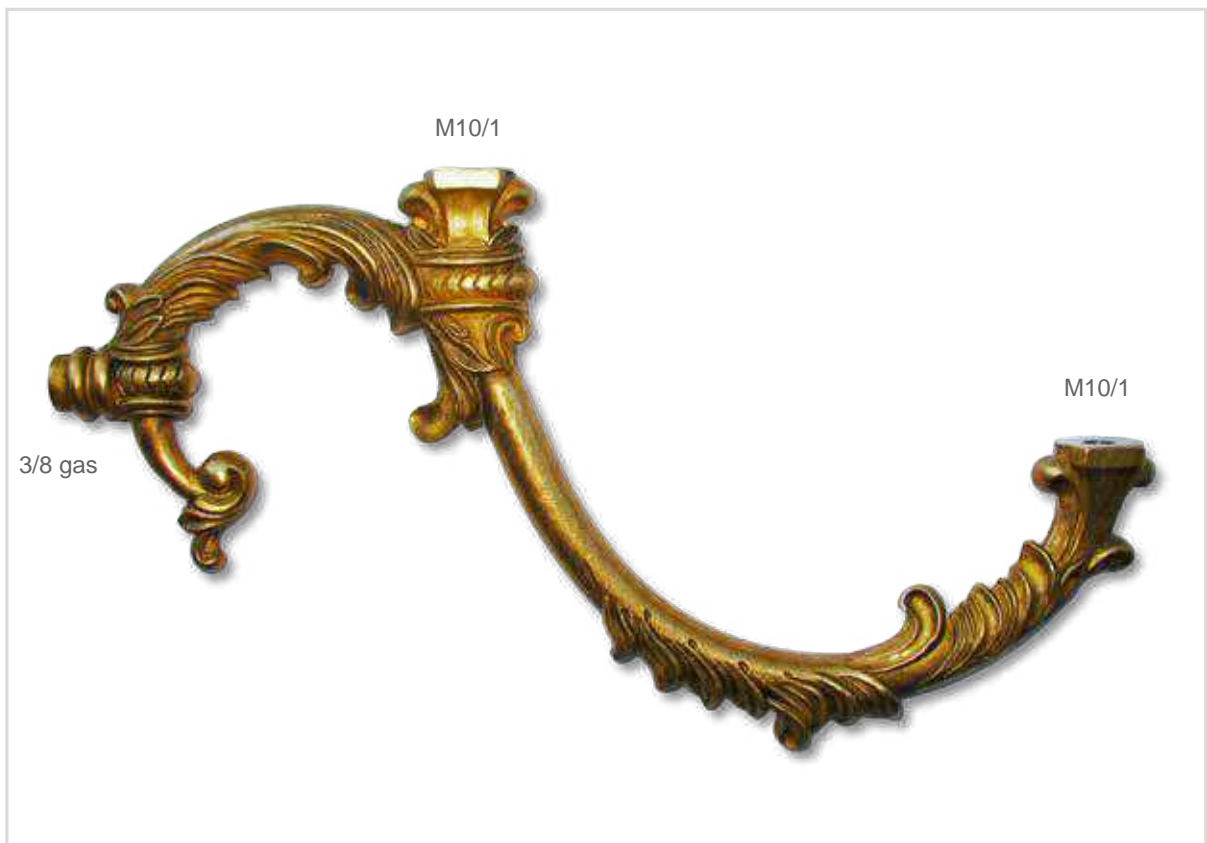

25-097
L360 x W32 x H190
filetto/thread M10/1
filetto/thread 3/8 gas



25-108
L360 x W32 x H170
filetto/thread M10/1



25-109
L250 x W24 x H180
filetto/thread M10/1

25-110
L300 x W24 x H240
filetto/thread M10/1

25-111
L405 x W26 x H300
filetto/thread M10/1



25-114
 L230 x W40 x H170
 filetto/thread M10/1

25-115
 L280 x W40 x H220
 filetto/thread M10/1



25-116
 L230 x W40 x H220
 filetto/thread M10/1

25-117
 L300 x W55 x H320
 filetto/thread M10/1



25-112
L240 x W31 x H100
filetto/thread M10/1

25-113
L305 x W27 x H115
filetto/thread M10/1



25-122
L150 x W18 x H62
filetto/thread M10/1

25-123
L195 x W20 x H82
filetto/thread M10/1

25-120
L315 x W29 x H145
filetto/thread M10/1

25-121
L400 x W34 x H180
filetto/thread M10/1



25-119
L105 x W16 x H260
filetto/thread M10/1

25-118
L140 x W20 x H350
filetto/thread M10/1



25-104
L250 x W26 x H98
filetto/thread M10/1

25-105
L350 x W35 x H135
filetto/thread M10/1



25-106
L250 x W26 x H308
filetto/thread M10/1

25-107
L350 x W35 x H370
filetto/thread M10/1



H603

L310 x W38 x H210
filetto/thread M10/1



25-089

L330 x W38 x H210
filetto/thread M10/1



Braccio saldato - Welded arm

H850

L570 x W60 x H280
filetto/thread M10/1



H840

L50 x W32 x H60
filetto/thread M 13/1



H841

L210 x W60 x H140
filetto/thread M 13/1



F514

Ø40 x H26
filetto/thread M 13/1



H842

L355 x W60 x H140
filetto/thread M 13/1



H753
 L140 x W17 x H75
 filetto/thread M10/1



H623
 L155 x W20 x H60
 filetto/thread M10/1



H643
 L145 x W25 x H85
 filetto/thread M10/1



25-056
 L160 x W20 x H110
 filetto/thread M10/1



H832

L180 x W20 x H140
filetto/thread M10/1



25-055

L240 x W25 x H170
filetto/thread M10/1



H651
L240 x W31 x H135
filetto/thread M10/1



H631
L160 x W19 x H100
filetto/thread M10/1

H630
L225 x W25 x H145
filetto/thread M10/1



H587
L180 x W20 x H85
filetto/thread M10/1

H588
L250 x W21 x H110
filetto/thread M10/1

H589
L295 x W28 x H180



H474
L170 x W20 x H100
filetto/thread M10/1

H475
L230 x W20 x H130
filetto/thread M10/1



H033
L155 x W31 x H100
filetto/thread M10/1



H034
L110 x W29 x H75
filetto/thread M10/1



H316
L110 x W20 x H115
filetto/thread M10/1



25-069
L120 x W27 x H75
filetto/thread M10/1



H313
L90 x W30 x H100
filetto/thread M10/1



H659
L140 x W40 x H130
filetto/thread M10/1



H091
L90 x W19 x H70
filetto/thread M10/1



H828
L90 x W16 x H50
filetto/thread M10/1



H829
L90 x W16 x H65
filetto/thread M10/1



H697
L120 x W20 x H80
filetto/thread M10/1



25-057
L135 x W27 x H90
filetto/thread M10/1



H040
L115 x W16 x H60
filetto/thread M10/1



H660
L250 x W40 x H185
filetto/thread M10/1



H524
L195 x W23 x H105
filetto/thread M10/1



H523
L45 x W23 x H95
filetto/thread M10/1



H163
L290 x W27 x H60
filetto/thread M10/1



H519
L190 x W24 x H155
filetto/thread M10/1

H520
L300 x W24 x H250
filetto/thread M10/1



25-079
L90 x W28 x H320
filetto/thread M10/1



25-020
L75 x W21 x H250
filetto/thread M10/1



H636

L175 x W27 x H275
filetto/thread M10/1



H672
L130 x W21 x H310
filetto/thread M10/1



H668
L155 x W17 x H230
filetto/thread M10/1



H458
L110 x W21 x H165
filetto/thread M10/1

H402
L185 x W19 x H225
filetto/thread M10/1



25-054
L100 x W25 x H170
filetto/thread M10/1



H601
L75 x W23 x H165
filetto/thread M10/1

H459
L145 x W21 x H190
filetto/thread M10/1



H713
L270 x W37 x H400
filetto/thread M10/1



H246

L185 x W21 x H225
filetto/thread M10/1

H245

L265 x W25 x H330
filetto/thread M10/1



25-016

L150 x W18 x H150
filetto/thread M10/1

25-015

L210 x W22 x H210
filetto/thread M10/1

25-014

L280 x W26 x H280
filetto/thread M10/1



H386

L145 x W21 x H105
filetto/thread M10/1

H382

L225 x W31 x H180
filetto/thread M10/1

H383

L300 x W40 x H230
filetto/thread M10/1



25-038

L160 x W22 x H110
filetto/thread M10/1

25-037

L225 x W24 x H150
filetto/thread M10/1



25-040

L140 x W15 x H120
filetto/thread M10/1

25-039

L200 x W20 x H165
filetto/thread M10/1



25-036
L190 x W25 x H150
filetto/thread M10/1

25-035
L245 x W30 x H190
filetto/thread M10/1



H476
L230 x W21 x H180
filetto/thread M10/1



H719
L310 x W25 x H230
filetto/thread M10/1



H830
L140 x W22 x H100
filetto/thread M10/1



H041
L95 x W22 x H100
filetto/thread M10/1

H146
L175 x W23 x H165
filetto/thread M10/1



25-029
L115 x W24 x H140
filetto/thread M10/1

25-028
L135 x W24 x H175
filetto/thread M10/1

25-027
L225 x W24 x H160
filetto/thread M10/1



H739
L255 x W22 x H210
filetto/thread M10/1



H740
L250 x W28 x H165
filetto/thread M10/1

H741
L360 x W28 x H190
filetto/thread M10/1



H604

L170 x W22 x H355
filetto/thread M10/1



H678

L155 x W17 x H270
filetto/thread M10/1



H730
L185 x W26 x H300
filetto/thread M10/1



H671
L140 x W20 x H290
filetto/thread M10/1



H805
L95 x W17 x H145
filetto/thread M10/1



H806
L75 x W17 x H65
filetto/thread M10/1



H677
L130 x W18 x H140
filetto/thread M10/1



H731
L330 x W26 x H225
filetto/thread M10/1



H810
L175 x W45 x H175
filetto/thread M10/1



H814
L175 x W45 x H200
filetto/thread M10/1



H812
L140 x W45 x H150
filetto/thread M10/1



H813
L140 x W50 x H145
filetto/thread M10/1



H836
L50 x W50 x H190
filetto/thread M10/1



H819
L65 x W35 x H100
filetto/thread M10/1

H820
L75 x W35 x H130
filetto/thread M10/1



H818
L90 x W30 x H100
filetto/thread M10/1



H809
L120 x W25 x H65
filetto/thread M10/1



H852
L30 x W15 x H80



H853
L30 x W15 x H80



H851
L150 x W25 x H100
filetto/thread M10/1



Immagine braccio cigno montato
Picture assembled swan arm

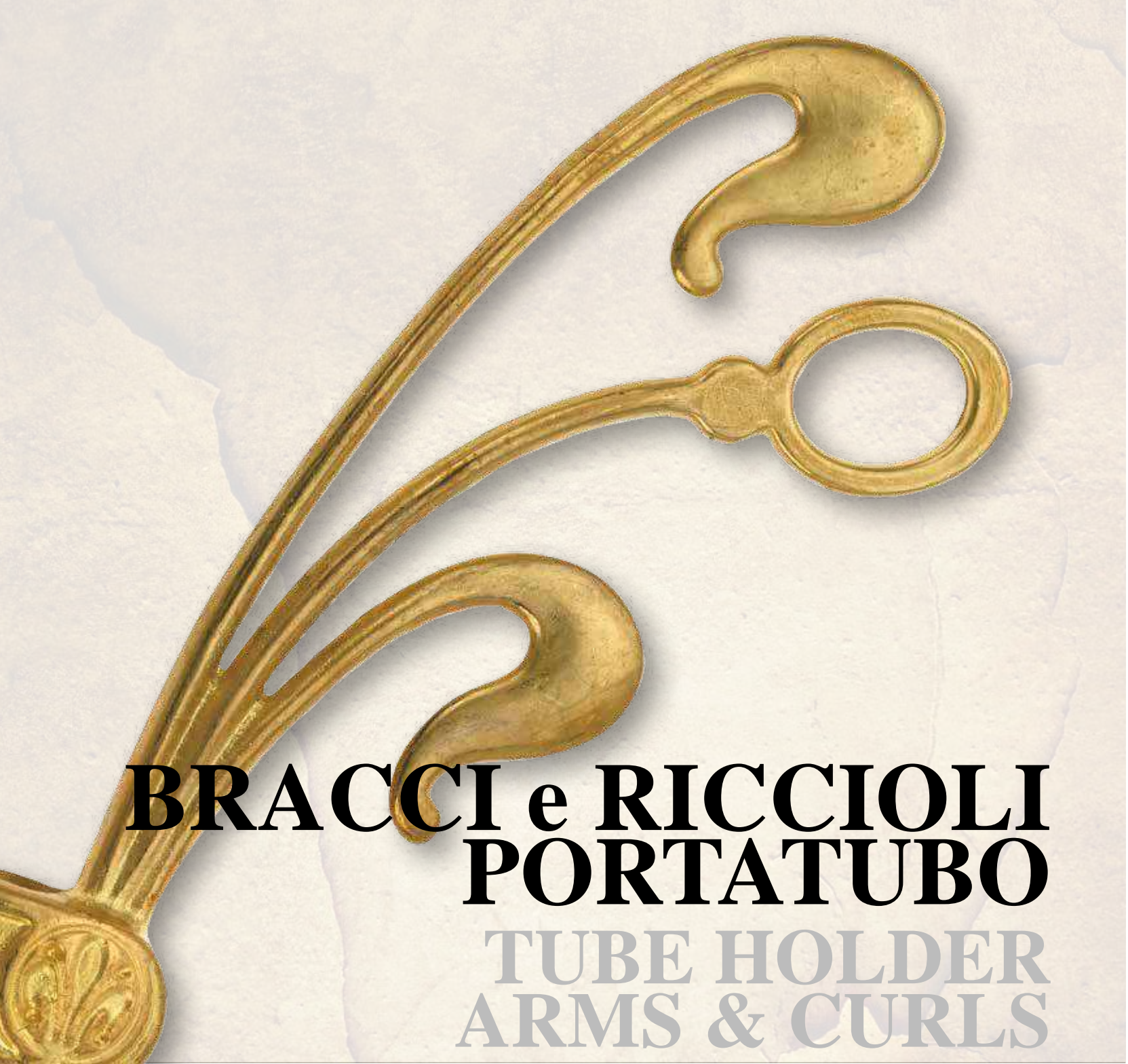

BRACCI e RICCIOLI PORTATUBO

TUBE HOLDER ARMS & CURLS

Letture misure:

Measurement legenda:

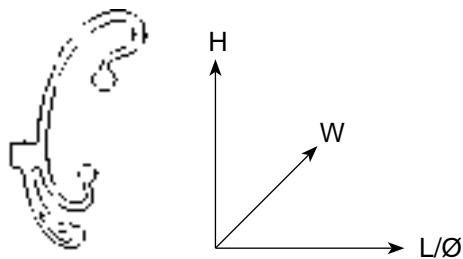

L= Lunghezza/Length

H= Altezza/Height

W= Larghezza/Width

Ø= Diametro/Diameter

Tutti gli articoli filettati M 10/1 sono disponibili con filettatura 1/8 IPS. Per identificare la filettatura 1/8 IPS è necessario aggiungere il suffisso "-01" alla fine di ogni codice articolo.

All Framon threaded articles are M10/1 type; 1/8 IPS thread version is available on customer demand. To obtain 1/8 IPS suffix "-01" must be added at the end of the article code.

Esempio - Example:

27-005 = filetto/thread M 10/1

27-005-01 = filetto/thread 1/8 IPS



27-005

L140 x W17 x H220
filetto/thread M10/1
alloggio tubo/tube housing Ø10,2



27-006

L125 x W16 x H220
filetto/thread M10/1
alloggio tubo/tube housing Ø10,2



27-008

L95 x W18 x H195
filetto/thread M10/1
alloggio tubo/tube housing Ø10,2



27-007

L100 x W20 x H200
filetto/thread M10/1
alloggio tubo/tube housing Ø10,2



27-010

L105 x W16 x H200
filetto/thread M10/1
alloggio tubo/tube housing Ø10,2



27-011

L120 x W17 x H260
filetto/thread M10/1
alloggio tubo/tube housing Ø10,2



27-012

L90 x W18 x H230
filetto/thread M10/1
alloggio tubo/tube housing Ø10,2



27-014

L75 x W16 x H190
filetto/thread M10/1
alloggio tubo/tube housing Ø10,2



27-017

L140 x W16 x H210
filetto/thread M10/1
alloggio tubo/tube housing Ø10,2



27-046

L90 x W16 x H225
filetto/thread M10/1
alloggio tubo/tube housing Ø10,2



27-003
L105 x W19 x H150
filetto/thread M10/1

27-002
L140 x W19 x H200
filetto/thread M10/1

27-001
L180 x W22 x H300
filetto/thread M10/1



27-047

L85 x W17 x H180
filetto/thread M10/1
alloggio tubo/tube housing Ø10,2



27-048

L75 x W17 x H155
filetto/thread M10/1
alloggio tubo/tube housing Ø10,2



27-019

L120 x W17 x H170
filetto/thread M10/1
alloggio tubo/tube housing Ø10,2



27-039

L100 x W17 x H170
filetto/thread M10/1
alloggio tubo/tube housing Ø10,2



27-032
 L110 x W16 x H170
 filetto/thread M10/1
 alloggiamento tubo/tube housing Ø10,2



27-035
 L100 x W16 x H170
 filetto/thread M10/1
 alloggiamento tubo/tube housing Ø10,2



27-033
 L90 x W16 x H160
 filetto/thread M10/1
 alloggiamento tubo/tube housing Ø10,2



27-034
 L100 x W15 x H160
 filetto/thread M10/1
 alloggiamento tubo/tube housing Ø10,2



27-049

L75 x W15 x H180
filetto/thread M10/1
alloggio tubo/tube housing Ø10,2



27-044

L70 x W14 x H160
filetto/thread M10/1
alloggio tubo/tube housing Ø10,2



27-031

L110 x W16 x H160
filetto/thread M10/1
alloggio tubo/tube housing Ø10,2



27-050

L85 x W16 x H170
filetto/thread M10/1
alloggio tubo/tube housing Ø10,2



27-021
L95 x W16 x H140
filetto/thread M10/1



27-022
L75 x W16 x H130
filetto/thread M10/1



27-027
L65 x W17 x H135
filetto/thread M10/1



27-029
L80 x W16 x H130
filetto/thread M10/1



27-045

L100 x W16 x H235
filetto/thread M10/1
alloggio tubo/tube housing \varnothing 10,2



27-042

L50 x W20 x H145
1° filetto/first thread M10/1
2° filetto/second thread M10/1



D301

L170 x W22 x H115
filetto/thread M10/1

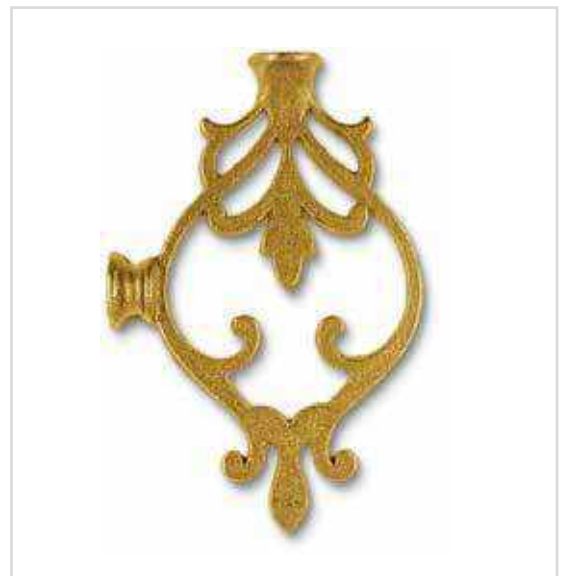

27-043

L80 x W20 x H120
1° filetto/first thread M10/1
2° filetto/second thread M10/1



28-024
 L85 x W17 x H100
 filetto/thread M10/1
 alloggiamento tubo/tube housing Ø10,2



28-016
 L75 x W17 x H100
 filetto/thread M10/1
 alloggiamento tubo/tube housing Ø10,2



28-018
 L75 x W16 x H95
 filetto/thread M10/1
 alloggiamento tubo/tube housing Ø10,2



28-022
 L90 x W20 x H100
 filetto/thread M10/1
 alloggiamento tubo/tube housing Ø10,2



D262
 L85 x W18 x H100
 filetto/thread M10/1
 alloggiamento tubo/tube housing Ø10,2



28-019
 L65 x W15 x H110
 filetto/thread M10/1
 alloggiamento tubo/tube housing Ø10,2



28-020

L70 x W14 x H100
filetto/thread M10/1
alloggio tubo/tube housing Ø10,2



29-132

L73 x W20 x H55
filetto/thread M10/1
alloggio tubo/tube housing Ø10,2



28-026

L45 x W19 x H50
filetto/thread M10/1
alloggio tubo/tube housing Ø10,2



28-003

L80 x W20 x H75
filetto/thread M10/1
alloggio tubo/tube housing Ø10,2



28-011

L45 x W15 x H65
filetto/thread M10/1
alloggio tubo/tube housing Ø10,2

28-010

L65 x W16 x H90
filetto/thread M10/1
alloggio tubo/tube housing Ø10,2



28-002

L70 x W17 x H75
filetto/thread M10/1
alloggio tubo/tube housing Ø10,2



28-009

L45 x W14 x H40
filetto/thread M10/1
alloggio tubo/tube housing Ø10,2

28-007

L60 x W14 x H60
filetto/thread M10/1
alloggio tubo
tube housing Ø10,2

28-008

L55 x W14 x H45
filetto/thread M10/1
alloggio tubo/tube housing Ø10,2



28-004

L65 x W19 x H55
filetto/thread M10/1
alloggio tubo/tube housing Ø10,2



28-012

L50 x W15 x H55
filetto/thread M10/1
alloggio tubo/tube housing Ø10,2



Fregi e Riccioli	309	29-088	309	D078	317	V129	327
29-005	312	29-089	309	D082	324	V130	327
29-006	312	29-092	312	D086	323	V131	327
29-010	313	29-097	325	D089	323	V132	327
29-011	313	29-099	327	D092	322	Z272	325
29-012	313	29-100	311	D094	333	Z273	325
29-013	313	29-101	322	D126	310	Z274	325
29-014	313	29-102	314	D142	315	Z278	325
29-016	313	29-103	322	D153	314		
29-017	313	29-104	322	D166	325	Lanterne	335
29-018	323	29-105	322	D171	325	30-007	337
29-019	309	29-106	313	D172	322	30-009	335
29-020	309	29-108	312	D181	315	30-010	336
29-021	309	29-109	328	D182	324	30-011	340
29-022	309	29-110	325	D186	324	30-014	348
29-023	312	29-112	312	D189	324	30-015	348
29-025	323	29-115	321	D195	315	30-019	360
29-028	322	29-119	323	D281	316	30-020	361
29-029	314	29-121	309	D300	327	30-022	361
29-030	317	29-122	312	L111	327	30-023	358
29-033	324	29-123	311	P014	319	30-024	356
29-035	314	29-124	311	P018	321	30-026	346
29-038	311	29-125	324	P019	324	30-027	346
29-039	311	29-127	309	P020	318	30-030	349
29-040	311	29-128	329	P026	316	30-032	349
29-041	311	29-129	329	P044	320	30-034	347
29-042	311	29-130	324	P045	320	30-035	340
29-043	326	29-131	309	P046	319	30-036	341
29-044	326	29-133	332	P060	326	30-038	337
29-047	312	29-134	332	P061	326	30-040	343
29-048	312	29-135	332	P062	326	30-044	349
29-049	333	29-136	332	P063	326	30-047	344
29-053	328	29-137	332	P064	310	30-048	345
29-054	328	29-139	331	P065	310	30-050	338
29-055	330	29-140	331	P066	326	30-054	342
29-056	330	29-141	326	V002	327	30-055	342
29-057	328	29-142	326	V007	327	30-056	343
29-058	329	D002	330	V008	327	30-057	338
29-059	329	D013	331	V017	328	30-058	338
29-062	317	D017	330	V024	328	30-059	338
29-063	313	D024	330	V047	329	30-060	336
29-064	314	D027	330	V051	329	30-061	354
29-065	314	D029	328	V056	328	30-062	351
29-068	324	D032	331	V062	333	30-063	350
29-069	310	D033	330	V066	325	30-064	353
29-070	310	D034	331	V088	325	30-065	352
29-072	310	D038	331	V091	325	30-066	350
29-073	310	D041	332	V098	329	D299	341
29-075	310	D041-01	332	V115	328	H704	339
29-077	310	D046	333	V120	325	P042	355
29-078	310	D055	333	V121	325	P050	357
29-079	310	D058	315	V126	327	Z181	359
29-080	311	D060	315	V127	327		
29-086	315	D061	332	V128	327		

**FREGI
RICCIOLI
LANTERNE**
ORNAMENTS
CURLS
LANTERNS

Fregi e Riccioli
Ornaments & Curls

p.309

Lanterne
Lanterns

p.335



FREGI E RICCIOLI

ORNAMENTS

Lettura misure:

Measurement legenda:

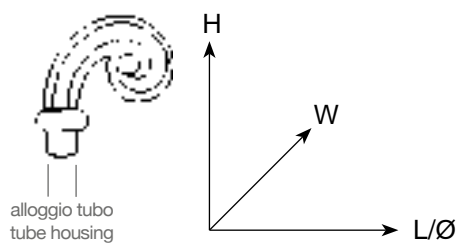

L= Lunghezza/Length

H= Altezza/Height

W= Larghezza/Width

Ø= Diametro/Diameter



29-019
L40 x W6 x H160



29-021
L45 x W6 x H160



29-020
L45 x W6 x H170



29-131
L50 x W7 x H95



29-022
L40 x W5 x H95



29-127
L58 x W11 x H174



29-089
L75 x W13 x H90



29-088
L75 x W17 x H100



29-121
L50 x W18 x H70



29-070
L14 x W14 x H25
alloggio tubo
tube housing Ø5,2



29-072
L15 x W15 x H30
alloggio tubo
tube housing Ø6,5



29-075
L27 x W10 x H26
alloggio tubo
tube housing Ø5,5



29-073
L35 x W15 x H30
alloggio tubo
tube housing Ø8



29-069
L40 x W11 x H30
alloggio tubo/tube housing Ø9,2



29-077
L55 x W12 x H50
alloggio tubo/tube housing Ø6,3



29-078
L55 x W15 x H65
alloggio tubo/tube housing Ø5,6



29-079
L65 x W13 x H70
alloggio tubo/tube housing Ø9

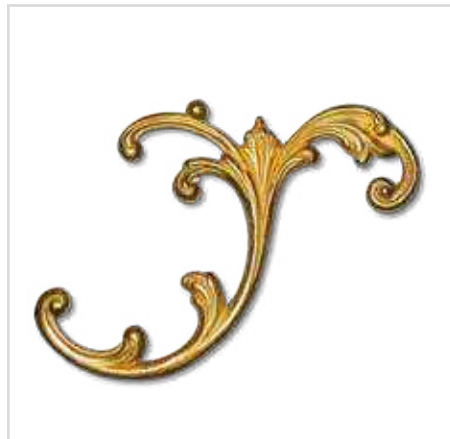

P065
L100 x W6,5 x H90

P064
L150 x W10 x H120



D126
L50 x W13 x H105



29-080
L45 x W10 x H70
alloggio tubo/tube housing Ø8,4



29-042
L35 x W7 x H50



29-041
L40 x W12 x H75



29-038
L40 x W7 x H110



29-039
L60 x W9 x H110



29-040
L45 x W10 x H120



29-124
L30 x W5 x H100



29-100
L50 x W5 x H140



29-123
L45 x W7 x H120



29-108
L45 x W6 x H95



29-112
L60 x W8 x H160



29-005
L60 x W4 x H165



29-122
L45 x W10 x H90



29-092
L45 x W12 x H130



29-006
L70 x W4 x H125



29-023
L35 x W6 x H95



29-047
L90 x W7 x H110



29-048
L90 x W7 x H100



29-011
L60 x W7 x H140



29-010
L60 x W7 x H155



29-012
L60 x W5 x H155



29-013
L40 x W5 x H80



29-016
L50 x W7 x H115



29-017
L50 x W6 x H100



29-014
L45 x W5 x H75



29-063
L65 x W6 x H100



29-106
L60 x W6 x H70



29-065
L35 x W6 x H120



29-064
L45 x W7 x H170



29-035
L50 x W6 x H185



29-102
L80 x W7 x H140



D153
L100 x W7 x H130



29-029
L70 x W5 x H130



D195
L70 x W7 x H155



D058
L50 x W20 x H195



D060
L60 x W28 x H185



D142
L40 x W7 x H100



29-086
L60 x W10 x H110



D181
L60 x W6 x H165



P026
L130 x W12 x H325

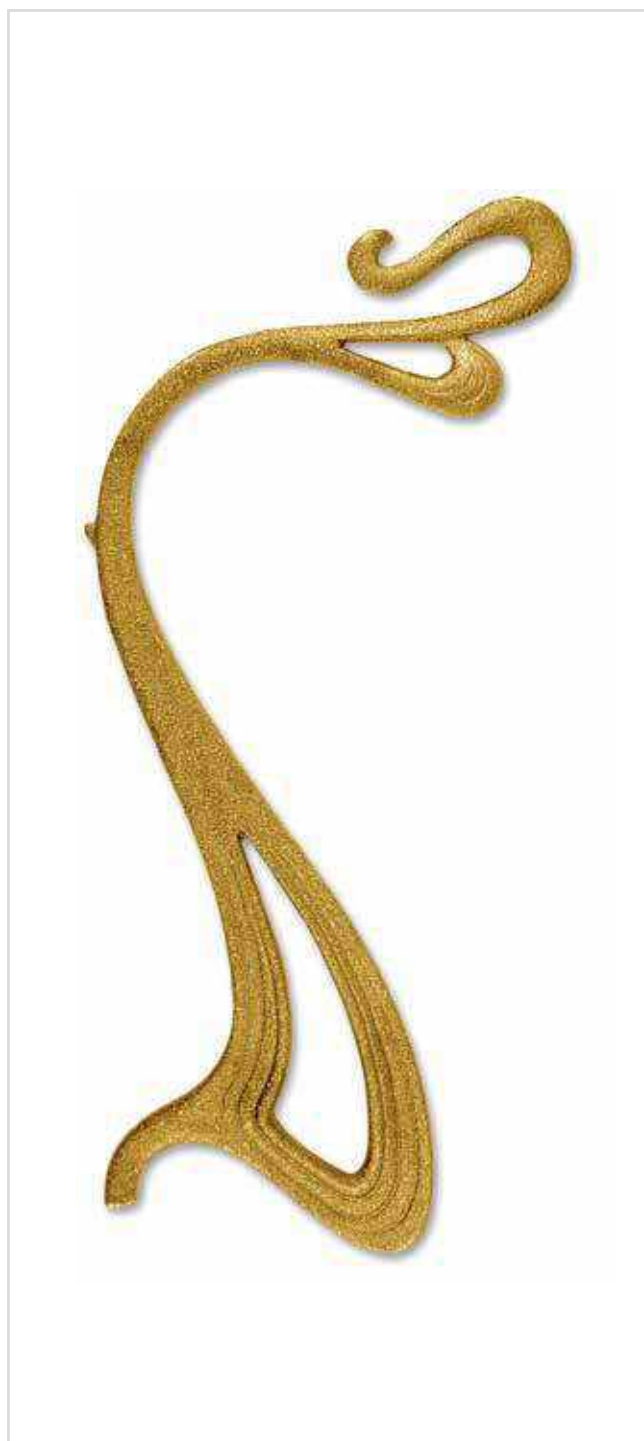

D281
L130 x W12 x H280



D078
L70 x W12 x H205



29-062
L60 x W11 x H200



29-030
L80 x W9 x H160



P020
L125 x W12 x H360



P046
L100 x W20 x H240



P014
L130 x W8 x H250



P044
L160 x W9 x H255



P045
L85 x W10 x H285



29-115
L120 x W8 x H240



P018
L140 x W4 x H360



D092
 L90 x W10 x H230



29-028
 L90 x W8 x H210



D172
 L55 x W9 x H160



29-104
 L55 x W6 x H90

29-103
 L110 x W8 x H130



29-105
 L70 x W7 x H100



29-101
 L50 x W6 x H120



D089
L100 x W10 x H215



29-119
L120 x W12 x H230



29-025
L55 x W7 x H175



29-018
L70 x W8 x H165



D086
L90 x W8x H190

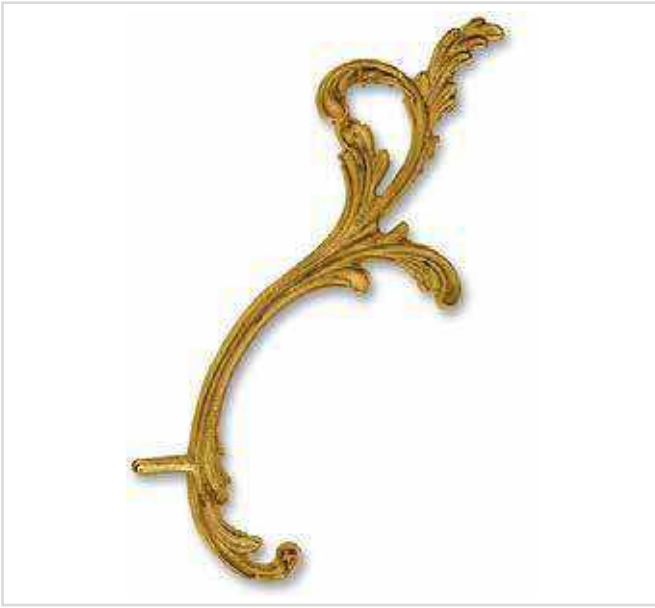

29-068
L50 x W7 x H140

P019
L120 x W9 x H220



D186
L100 x W11 x H165

D189
L70 x W7 x H155



D182
L120 x W6 x H90

D082
L140 x W10 x H200



29-125
L92 x W7 x H46



29-130
L90 x W10 x H75



29-033
L140 x W10 x H90



V088
L70 x W15 x H30



V121
L52 x W4 x H30

V120
L75 x W6 x H40



V066
L135 x W5 x H45



V091
L105 x W3 x H20



D171
L185 x W18 x H65



D166
L150 x W18 x H20



Z278
L25 x W6 x H15



29-110
L80 x W6 x H135



29-097
L100 x W8 x H50

Z272
L35 x W8 x H25

Z274
L105 x W15 x H75



P063
L35 x W6 x H150

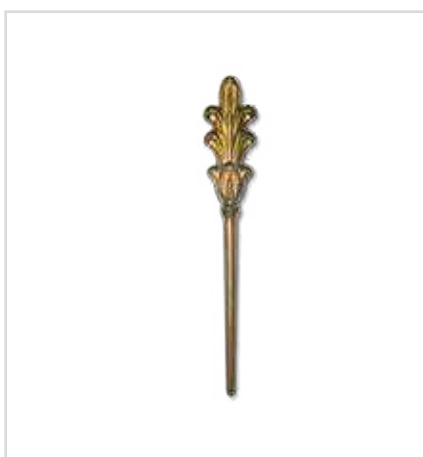

P060
L15 x W4,5 x H90



P061
L60 x W6,5 x H85



29-141
L30 x W5 x H95



29-043
L50 x W7 x H100



29-044
L30 x W5 x H110



P062
L60 x W4,5 x H70

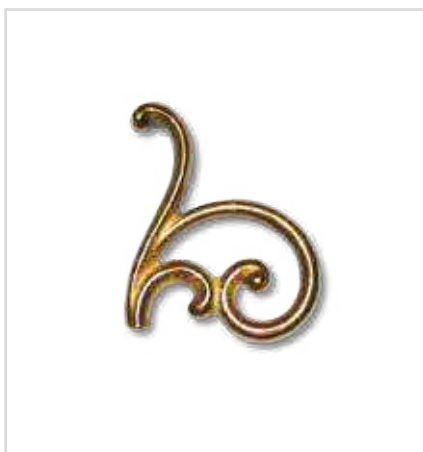

P066
L65 x W9,5 x H65

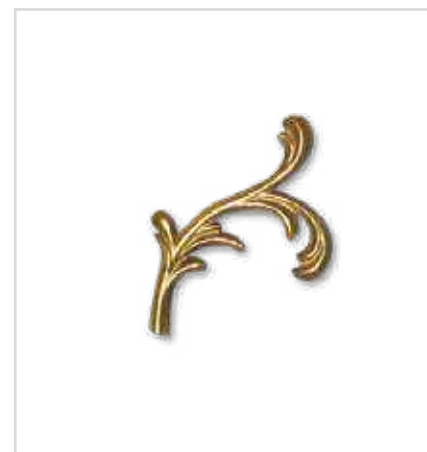

29-142
L40 x W10 x H65



V007
Ø18 x W4



V002
Ø28 x W6



V008
Ø39 x W10



V130
Ø40 x W11
filetto/thread 4 MA



V128
Ø18 x W8
filetto/thread 4 MA

V132
Ø41 x W10

V129
Ø28 x W10
filetto/thread 4 MA

V131
Ø35 x W8



D300
L75 x W8 x H120



29-099
L35 x W11 x H30



L111
L60 x W9 x H57
filetto/thread 5 MA



V126
L43 x W5 x H45

V127
L85 x W7 x H95



V017
L30 x W3 x H55



V024
L37 x W4 x H65



V115
L55 x W3 x H70



29-053
L45 x W4 x H60



29-054
L95 x W4 x H75



29-109
L75 x W4 x H75



D029
L40 x W45 x H130



V056
L60 x W3 x H130



29-057
L35 x W4 x H125



V098
L35 x W5 x H135



V051
L25 x W3 x H140



29-129
L25 x W3 x H197



29-059
L15 x W3 x H100



V047
L25 x W3 x H170

29-058
L20 x W3 x H125

29-128
L33 x W3 x H267



D017
L350 x W6 x H355



D027
L22 x W4 x H93



29-055
L20 x W20 x H120



D024
L18 x W4 x H127



D002
L23 x W5 x H137



D033
L22 x W4 x H205



29-056
L20 x W4 x H200



D013
L40 x W5 x H160



29-139
L45 x W5 x H135



29-140
L45 x W5 x H135



D032
L42 x W5 x H210



D038
L50 x W5 x H220



D034
L20 x W7 x H205



D061
 L30 x W35 x H170



D041
 L60 x W56 x H225
 piegata/curved



D041-01
 L60 x W6 x H235
 piatta/flat



29-133
 L65 x W10 x H70



29-135
 L40 x W10 x H115



29-136
 L50 x W8 x H70

29-134
 L95 x W10 x H105

29-137
 L60 x W8 x H85



29-049

L100 x W3 x H120

D055

L140 x W4 x H160



D094

L55 x W53 x H230



D046

L100 x W3 x H65

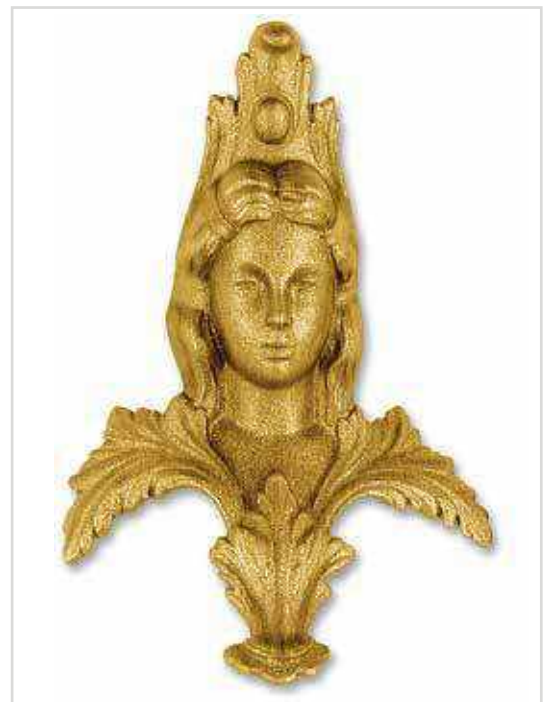

V062

L105 x W50 x H160



LANTERNE

LANTERNS

Letture misure:
Measurement legenda:

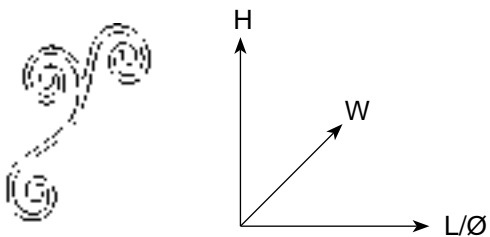

L= Lunghezza/Length
H= Altezza/Height
W= Larghezza/Width
Ø= Diametro/Diameter

Tutti gli articoli filettati M 10/1 sono disponibili con filettatura 1/8 IPS.
Per identificare la filettatura 1/8 IPS è necessario aggiungere il suffisso "-01" alla fine di ogni codice articolo.

All Framon threaded articles are M10/1 type; 1/8 IPS thread version is available on customer demand. To obtain 1/8 IPS suffix "-01" must be added at the end of the article code.

Esempio - Example:

30-009
30-009-01

filetto/thread M 10/1
filetto/thread 1/8 IPS



30-009

L150 x W18 x H290
filetto/thread M 10/1



30-010
L155 x W20 x H240
filetto/thread M 10/1



30-060
L140 x W15 x H220
filetto/thread M 10/1



30-038

L145 x W18 x H250
filetto/thread M 10/1



30-007

L130 x W18 x H220
filetto/thread M 10/1



30-057
L70 x W16 x H115
filetto/thread M 10/1



30-050
L95 x W33 x H100
filetto/thread M 10/1



30-059
L100 x W16 x H130
filetto/thread M 10/1



30-058
L80 x W18 x H150
filetto/thread M 10/1



H704

L150 x W20 x H220
filetto/thread M 10/1



30-040

L190 x W16 x H160
filetto/thread M 10/1



30-011
L160 x W16 x H180
filetto/thread M 10/1



30-035
L90 x W14 x H220



D299
L65 x W16 x H160
filetto/thread M 10/1



30-036
L140 x W18 x H220
filetto/thread M 10/1



30-054
L100 x W12 x H290



30-055
L55 x W8 x H200



30-056
L80 x W14 x H200
filetto/thread M 10/1



30-032
L165 x W18 x H185
filetto/thread M 10/1



30-047

L150 x W20 x H390
filetto/thread M 10/1



30-048

L155 x W20 x H410
filetto/thread M 10/1



30-027
L140 x W18 x H200
filetto/thread M 10/1



30-026
L165 x W18 x H200
filetto/thread M 10/1



30-034

L160 x W18 x H240
filetto/thread M 10/1

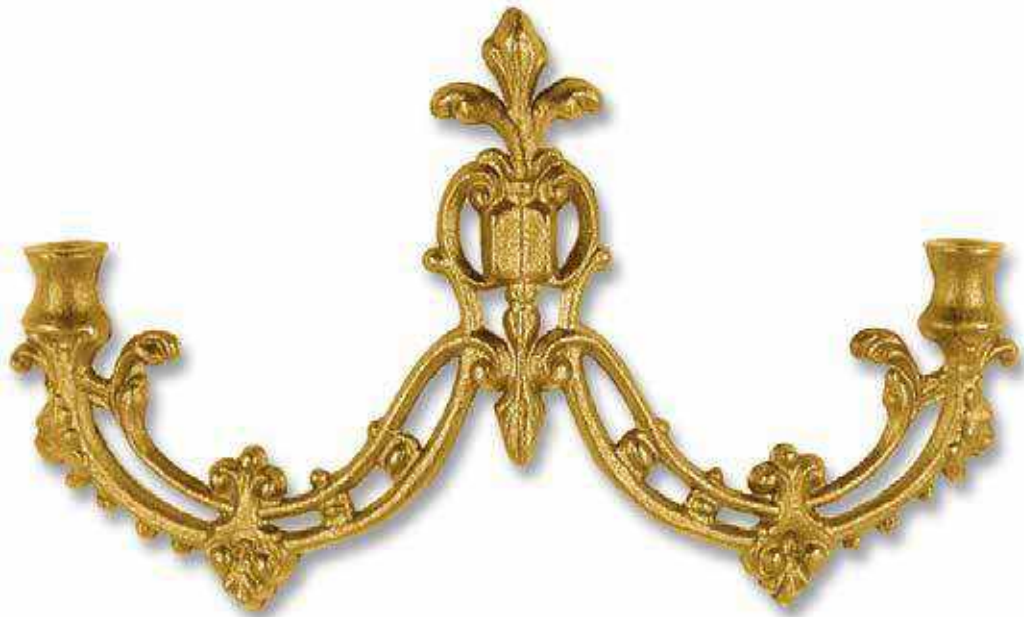

30-015

L210 x W55 x H135
filetto/thread M 10/1



30-014

L205 x W40 x H125
filetto/thread M 10/1



30-044

L130 x W16 x H140
filetto/thread M 10/1



30-030

L150 x W18 x H160
filetto/thread M 10/1



30-066
L200 x W14 x H240

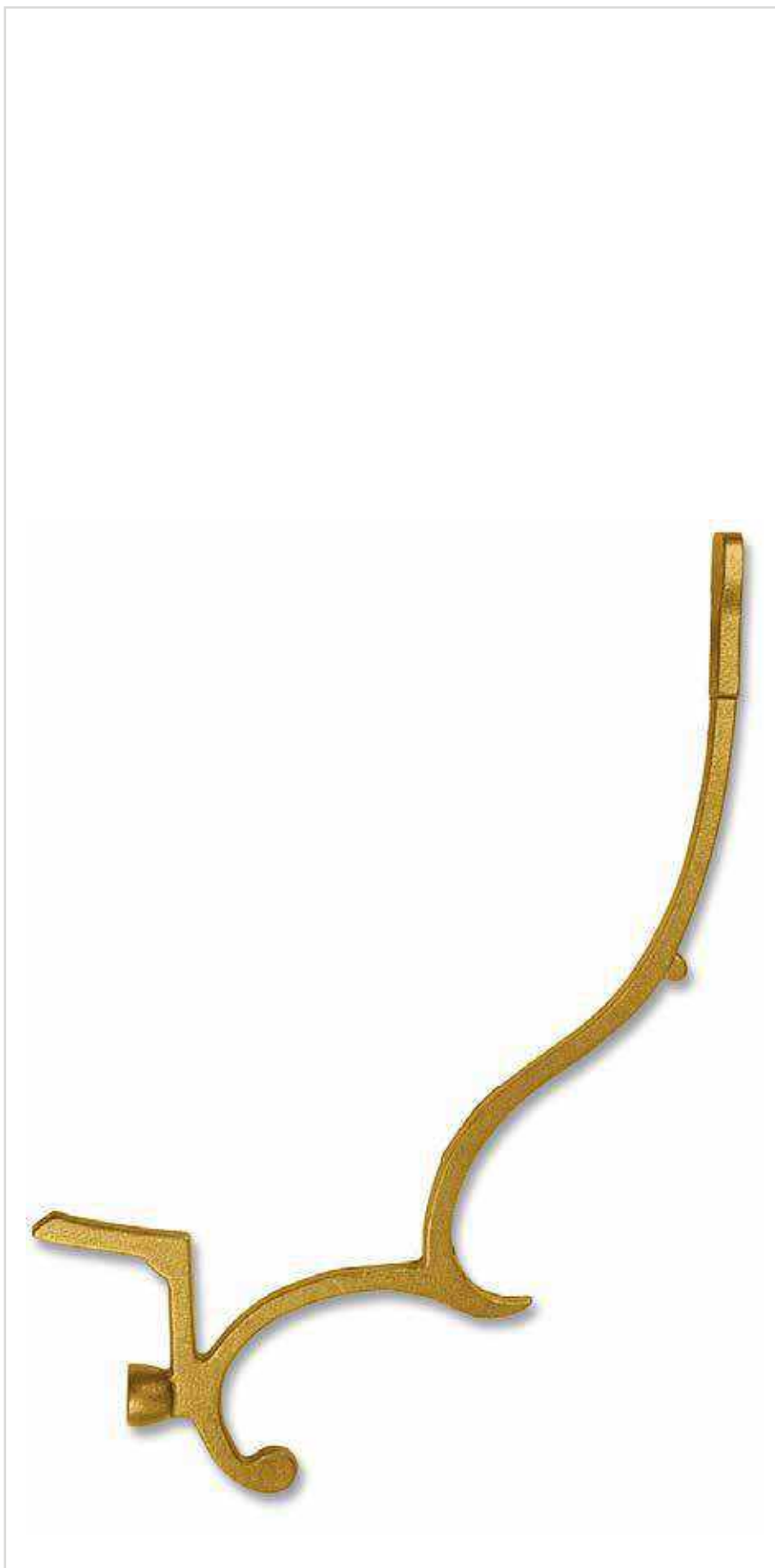

30-063
L180 x W16 x H260
filetto/thread M 10/1



30-062

L220 x W16 x H320
filetto/thread M 10/1



30-065

L165 x W16 x H290
filetto/thread M 10/1



30-064

L185 x W16 x H325
filetto/thread M 10/1



30-061

L240 x W16 x H300
filetto/thread M 10/1



P042

L230 x W20 x H290
primo foro/*first hole* Ø11



30-024

L280 x W20 x H290

primo foro/*first hole* Ø11



P050

L380 x W20 x H500
filetto/thread M 10/1



30-023

L290 x W20 x H320

primo foro/*first hole* Ø11



Z181
L175 x W50 x H390



30-019

L255 x W17 x H295
filetto/thread M 10/1



30-020
L20 x W15 x H260
filetto/thread M 10/1



30-021
L110 x W14 x H160
filetto/thread M 10/1



30-022
L100 x W32 x H115
primo foro/first hole Ø11

Basi	365						
053-32-054	429	32-081	404	R152	406	R242	385
32-001	401	32-082	404	R155	405	R243	385
32-002	404	A010	405	R156	371	R244	387
32-003	411	G197	397	R157	375	R245	434
32-006	376	G372	389	R158	431	R247	375
32-011	420	Q245	416	R159	378	R251	413
32-012	419	Q246	417	R160	378	R252	426
32-013	420	R024	388	R161	378	R253	387
32-014	419	R035	388	R164	368	R254	432
32-015	386	R038	388	R166	406	R255	426
32-016	422	R039	388	R167	428	R256	366
32-017	395	R041	391	R172	375	R256-03	366
32-018	400	R042	422	R174	381	R257	415
32-019	400	R043	419	R175	374	R258	415
32-023	388	R045	421	R176	373	R259	367
32-025	388	R047	422	R183	370	R262	366
32-026	399	R053	398	R184	370	R262-03	366
32-027	393	R058	428	R185	367	R263	407
32-028	419	R065	388	R186	365	R264	431
32-030	435	R069	399	R188	367	R265	427
32-031	435	R070	405	R189	365	R266	417
32-033	428	R072	428	R190	371	R267	417
32-034	431	R074	367	R191	389	R268	376
32-035	431	R075	367	R192	375	R269	390
32-042	374	R076	367	R193	365	R270	416
32-045	423	R077	367	R194	365	R271	375
32-046	423	R078	367	R195	365	R272	384
32-047	393	R079	367	R196	365	R273	378
32-048	393	R081	432	R197	386	R275	416
32-049	430	R082	374	R198	395	R276	394
32-050	377	R083	409	R199	386	R277	394
32-051	369	R086	370	R200	386	R278	394
32-052	369	R087	371	R201	395	R279	394
32-053	377	R088	370	R202	395	S022	414
32-054	429	R091	408	R203	388	S025	424
32-055	369	R093	413	R206	368	S034	396
32-056	429	R097	400	R207	368	S040	410
32-057	369	R107	391	R208	429	S041	402
32-058	369	R110	426	R208-20	427	S057	412
32-059	369	R112	401	R209	377	S058	409
32-061	385	R115	397	R210	377	S063	403
32-063	428	R117	376	R211	377	S064	373
32-064	429	R119	413	R212	377	S070	418
32-065	433	R120	398	R213	379	S071	418
32-067	379	R121	392	R214	379	S074	384
32-068	379	R125	392	R215	379	S075	384
32-069	379	R131	391	R216	379	S076	384
32-070	419	R132	390	R220	433	S080	383
32-071	390	R133	426	R221	433	S081	381
32-072	390	R134	427	R223	392	S082	382
32-073	390	R135	429	R224	430	S083	425
32-075	372	R135-20	427	R225	430	S087	424
32-076	372	R136	419	R226	372	S094	435
32-077	372	R137	421	R228	375	S095	434
32-078	372	R138	392	R232	432	S096	380
32-079	372	R139	392	R233	431	S097	380
32-080	430	R145	408	R234	433		
		R146	408	R235	433		
		R150	400	R241	385		

BASI BASES



BASI BASES

Lettura misure:
Measurement legenda:

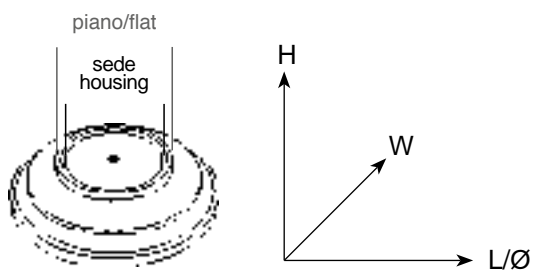

N.B. quota sedi specificata in NERO
housing dimension in BLACK

L= Lunghezza/Length
H= Altezza/Height
W= Larghezza/Width
Ø= Diametro/Diameter

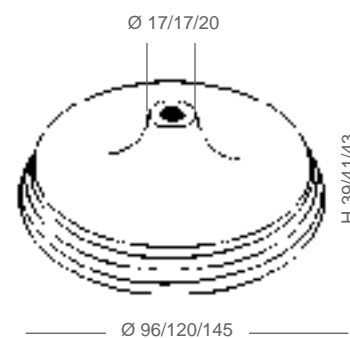

R193
Ø96 x H39
filetto/thread M 10/1

R189
Ø120 x H41
filetto/thread M 10/1

R186
Ø145 x H43
filetto/thread M 10/1

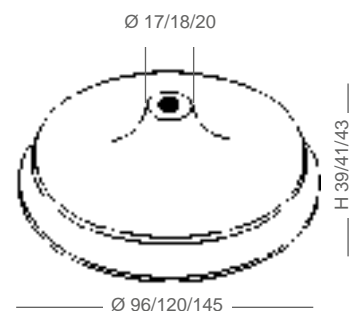

R196
Ø96 x H39
filetto/thread M 10/1

R195
Ø120 x H41
filetto/thread M 10/1

R194
Ø145 x H43
filetto/thread M 10/1

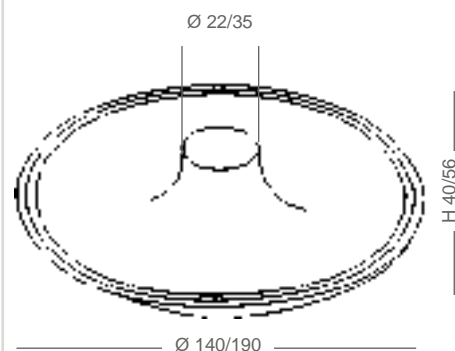

R262
Ø140 x H40

R256
Ø190 x H56

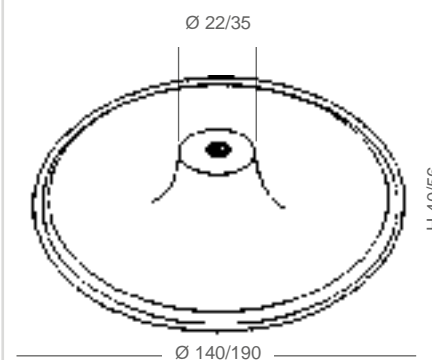

R262-03
Ø140 x H40
godronata/knurled

R256-03
Ø190 x H56
godronata/knurled



R259
Ø77 x H23
filetto/thread M 10/1

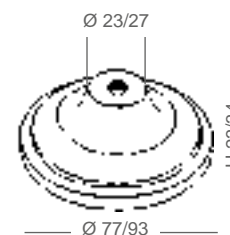

R079
Ø93 x H34
filetto/thread M 10/1



R074
Ø55 x H30
filetto/thread M 10/1

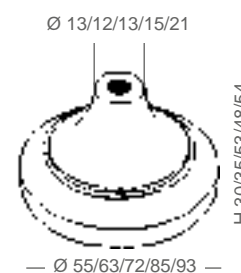

R075
Ø63 x H35
filetto/thread M 10/1

R076
Ø72 x H53
filetto/thread M 10/1

R077
Ø85 x H48
filetto/thread M 10/1

R078
Ø93 x H54
filetto/thread M 10/1



R188
Ø120 x H70
filetto/thread M 10/1

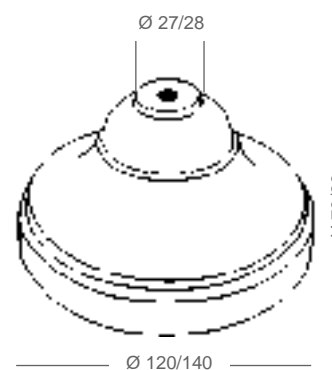

R185
Ø140 x H80
filetto/thread M 10/1

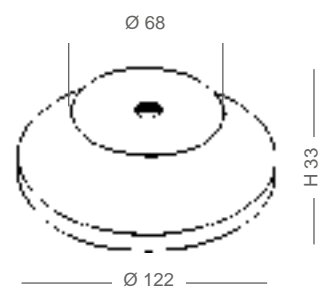

R164
Ø122 x H33

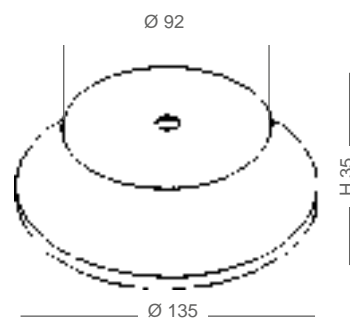

R207
Ø135 x H35

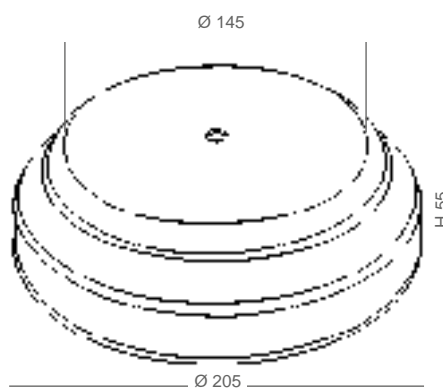

R206
Ø205 x H55



32-057
Ø120 x H33
stampato a caldo/hot pressing

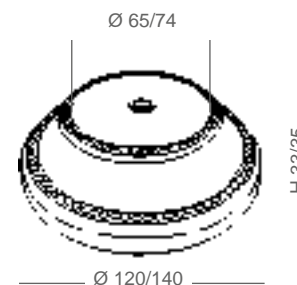

32-051
Ø140 x H35
stampato a caldo/hot pressing



32-058
Ø120 x H33
stampato a caldo/hot pressing

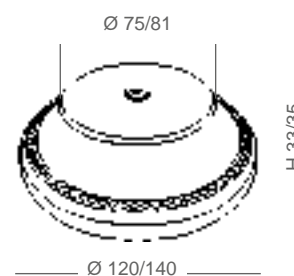

32-055
Ø140 x H35
stampato a caldo/hot pressing



32-059
Ø120 x H33
stampato a caldo/hot pressing

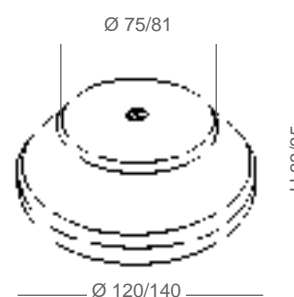

32-052
Ø140 x H35
stampato a caldo/hot pressing

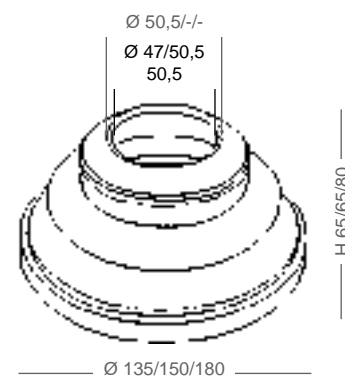

R183
Ø135 x H65

R088
Ø150 x H65

R184
Ø180 x H80

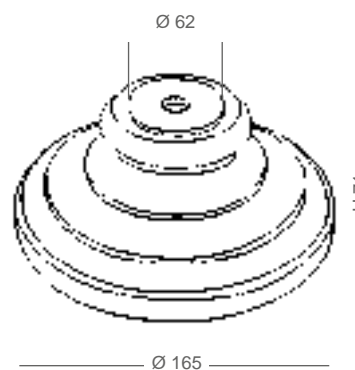

R086
Ø165 x H71



R087
 $\varnothing 160 \times H45$
 filetto/thread M 10/1
 stampato a caldo/hot pressing

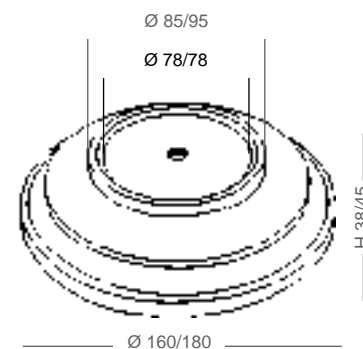

R190
 $\varnothing 180 \times H38$
 filetto/thread M 10/1
 stampato a caldo/hot pressing



R156
 $\varnothing 175 \times H60$

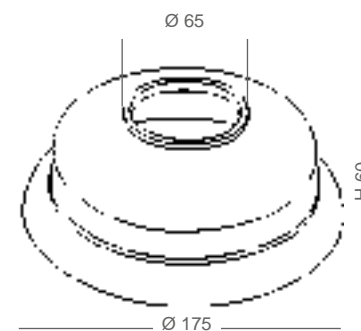

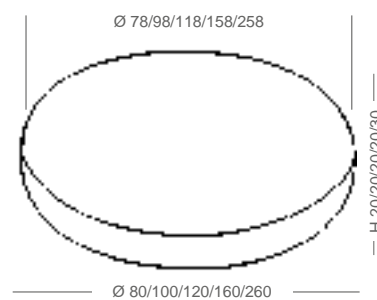

32-075
 $\varnothing 80 \times H20$

32-076
 $\varnothing 100 \times H20$

32-077
 $\varnothing 120 \times H20$

32-078
 $\varnothing 160 \times H20$

32-079
 $\varnothing 260 \times H30$

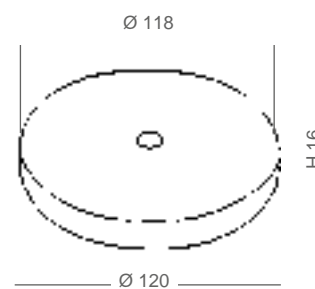

R226
 $\varnothing 120 \times H16$

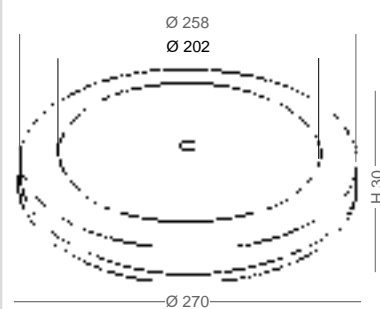

S064
Ø270 x H30

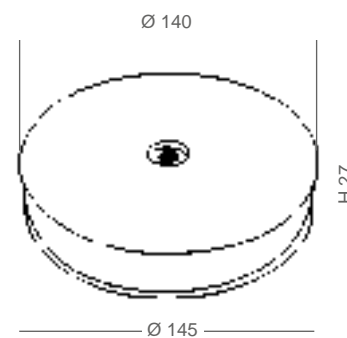

R176
Ø145 x H27
filetto/thread M 10/1

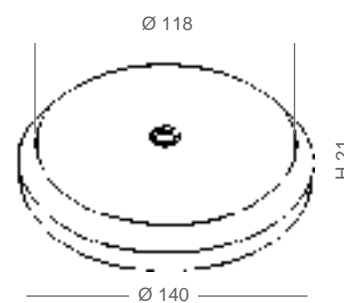

R082

Ø140 x H21
filetto/thread M 10/1

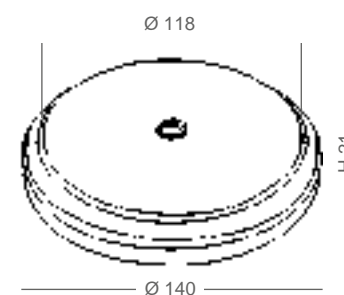

32-042

Ø140 x H21

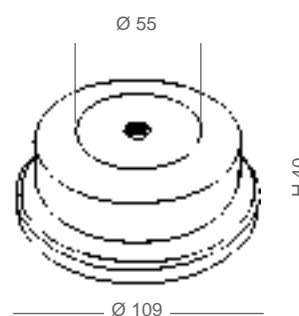

R175

Ø109 x H40
filetto/thread M 10/1

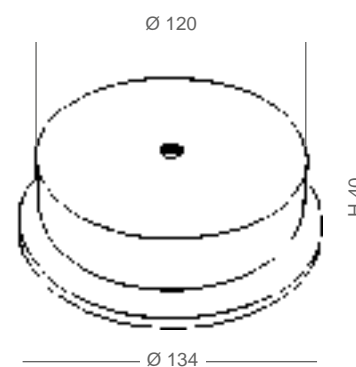

R172
Ø134 x H40
filetto/thread M 10/1

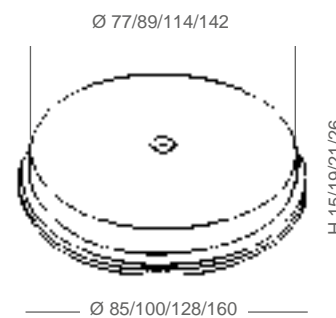

R192
Ø85 x H15

R157
Ø100 x H19

R228
Ø128 x H21

R247
Ø160 x H26

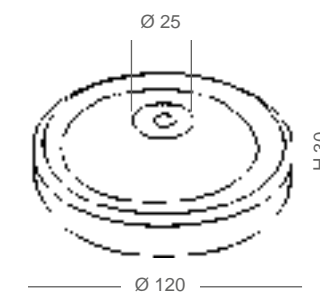

R271
Ø120 x H30



R268
 Ø150 x H42

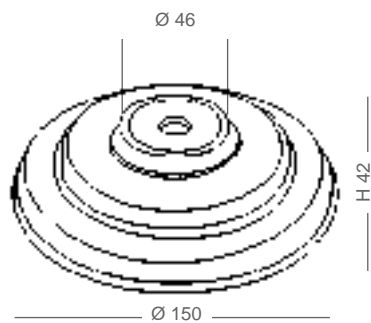

32-006
 Ø123 x H38

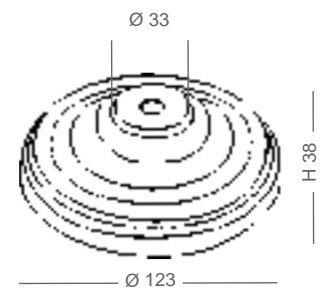

R117
 Ø180 x H115

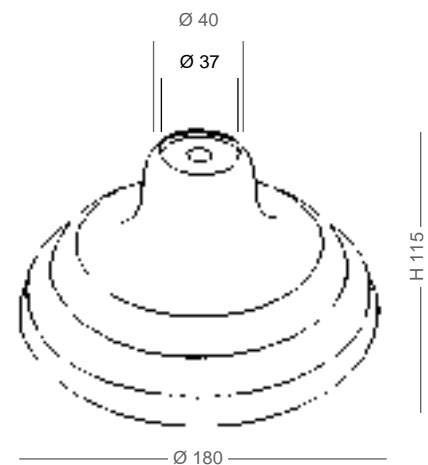



32-050
Ø125 x H63

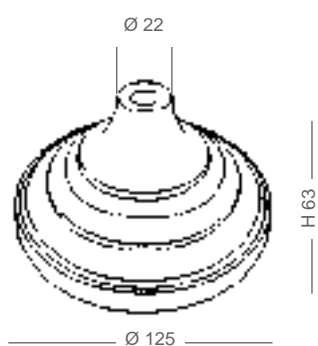

32-053
Ø125 x H63

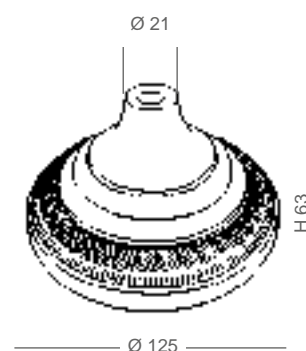

R212
Ø80 x H42

R211
Ø100 x H47

R210
Ø120 x H53

R209
Ø140 x H60

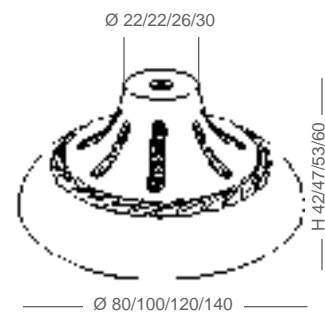

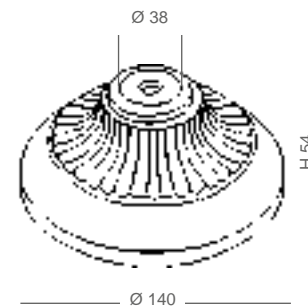

R273
 Ø140 x H54

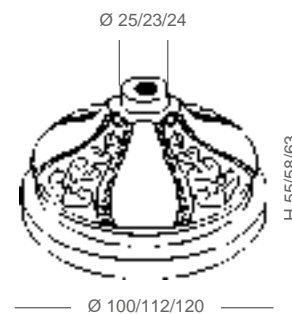

R161
 Ø100 x H55
 filetto/thread M 10/1

R160
 Ø112 x H58
 filetto/thread M 10/1

R159
 Ø120 x H63
 filetto/thread M 10/1

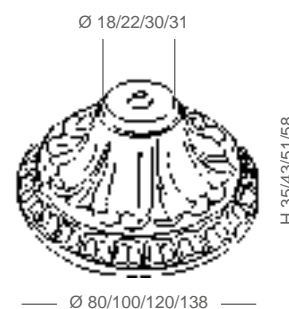

R216
Ø80 x H35

R215
Ø100 x H43

R214
Ø120 x H51

R213
Ø138 x H58

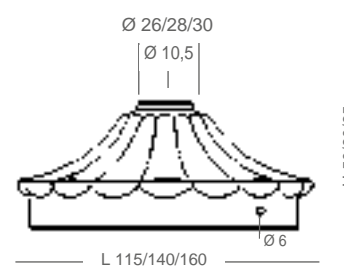

32-067
Ø115 x H50 foro/hole Ø10,5

32-068
Ø140 x H60 foro/hole Ø10,5

32-069
Ø160 x H65 foro/hole Ø10,5



S096
 Ø300 x H40

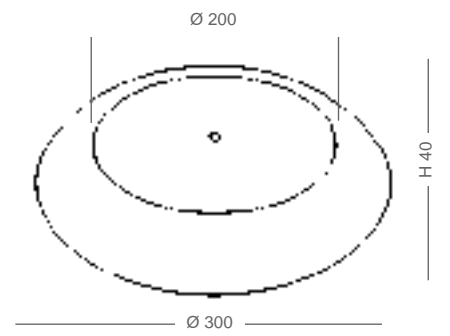

S097
 Ø200 x H30

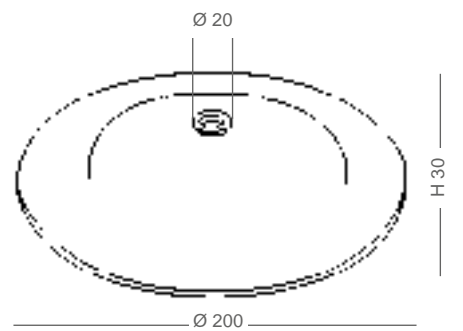



S081
L400 x W300 x H47

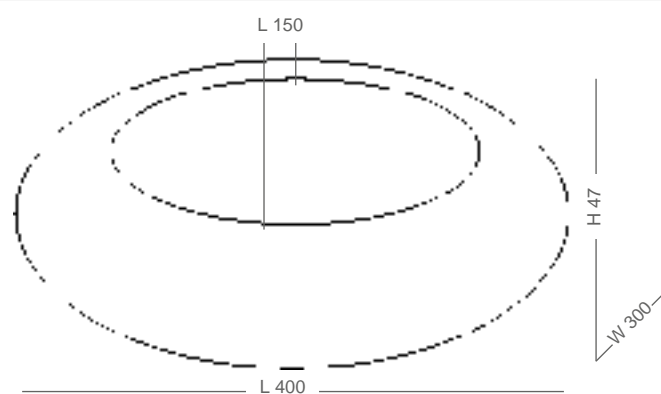

R174
Ø165 x H23
filetto/thread M 10/1

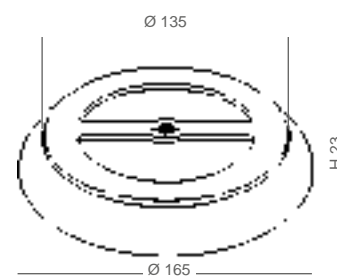



S082
L400 x W300 x H47

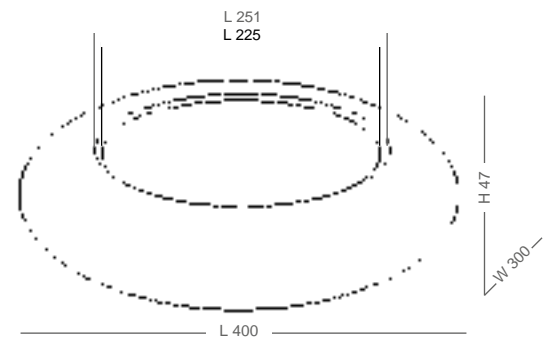



S080
Ø400 x H47

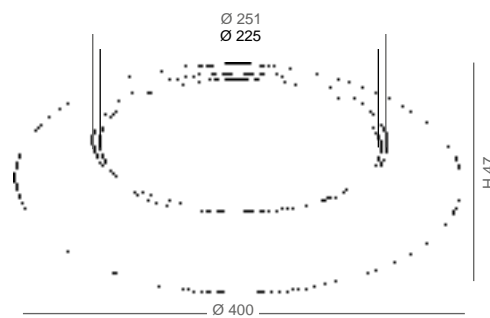



S074
L135 x W130 x H28

S076
L265 x W260 x H50

S075
L200 x W215 x H35

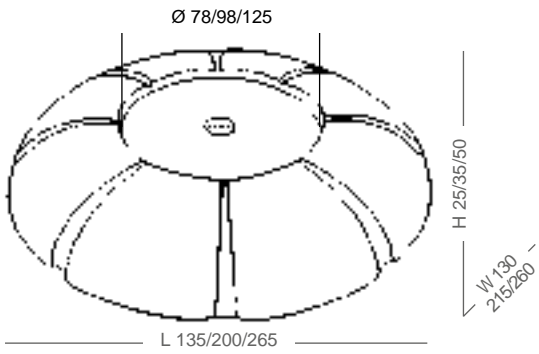

R272
 $\text{Ø}120 \times H30$

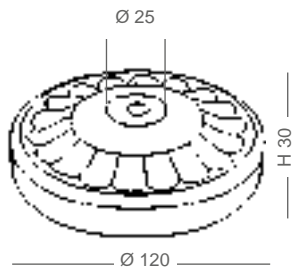



R241

L155 x W95 x H45

R243

L295 x W185 x H75

R242

L235 x W120 x H50

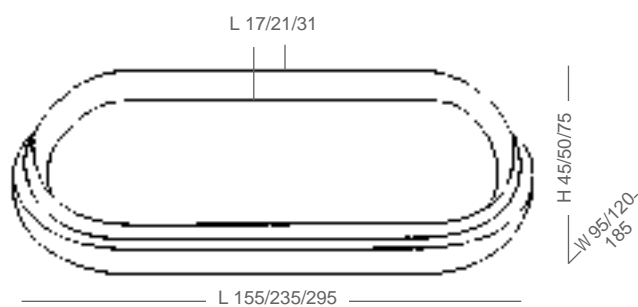

32-061

Ø140 x H20

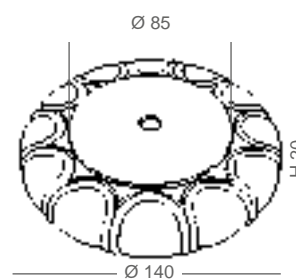

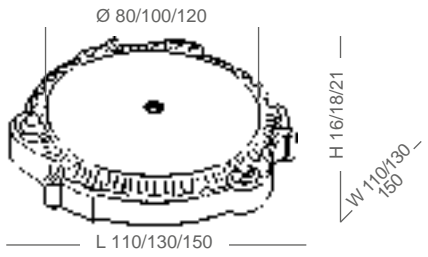

R199

L110 x W110 x H16
filetto/thread M 10/1

R197

L130 x W130 x H18
filetto/thread M 10/1

R200

L150 x W150 x H21
filetto/thread M 10/1

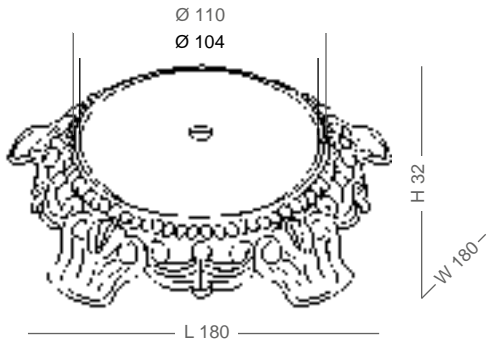

32-015

L180 x W180 x H32

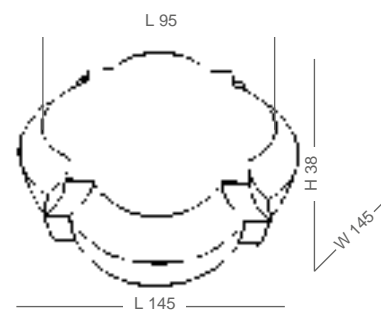

R253
L145 x W145 x H38

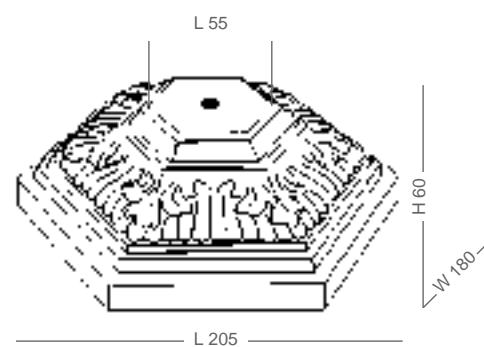

R244
L205 x W180 x H60
filetto/thread M 10/1

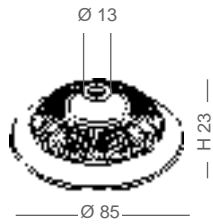

32-023
Ø85 x H23

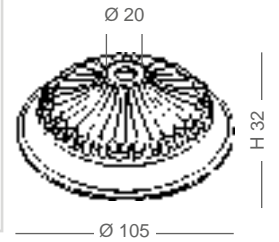

R038
Ø105 x H32
filetto/thread M 10/1

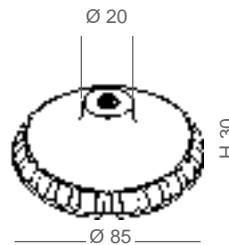

R035
Ø85 x H30
filetto/thread M 10/1

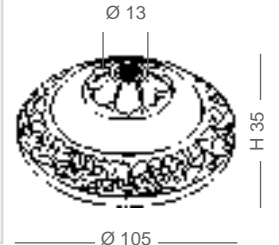

R039
Ø105 x H35
filetto/thread M 10/1

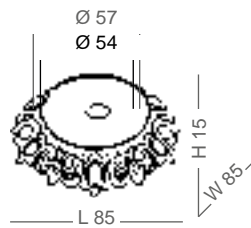

32-025
L85 x W85 x H15

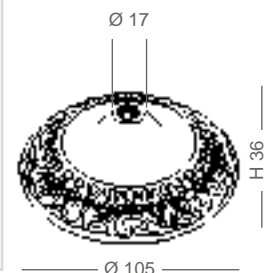

R065
Ø105 x H36
filetto/thread M 10/1

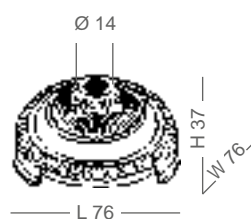

R024
L76 x W76 x H37
filetto/thread M 10/1

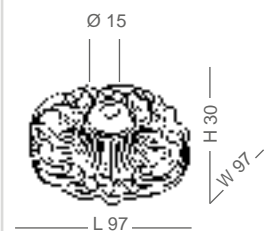

R203
L97 x W97 x H30

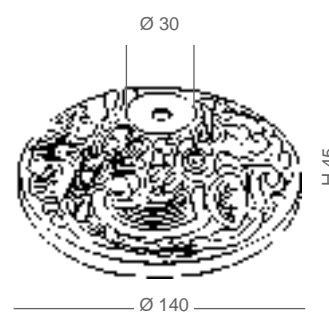

R191
Ø140 x H45
filetto/thread M 10/1

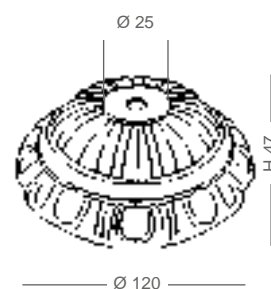

G372
Ø120 x H47

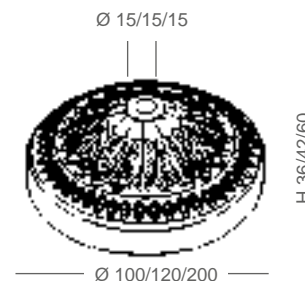

32-071
 Ø100 x H36 foro/hole Ø10,5
 piano sopra/upper flat Ø15

32-072
 Ø120 x H42 foro/hole Ø10,5
 piano sopra/upper flat Ø15

32-073
 Ø200 x H60 foro/hole Ø10,5
 piano sopra/upper flat Ø15

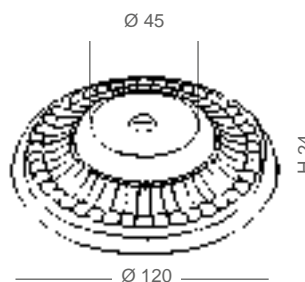

R132
 Ø120 x H24

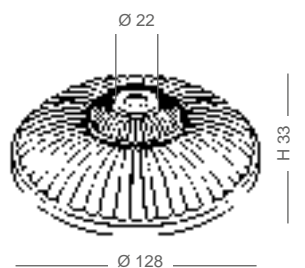

R269
 Ø128 x H33

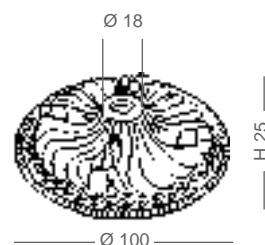

R041

Ø100 x H25
filetto/thread M 10/1

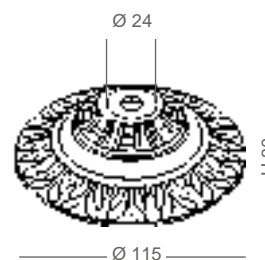

R131

Ø115 x H30

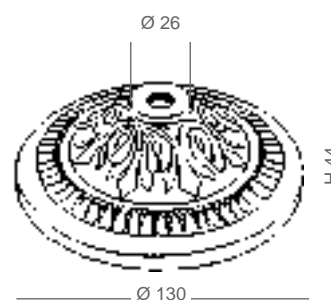

R107

Ø130 x H44

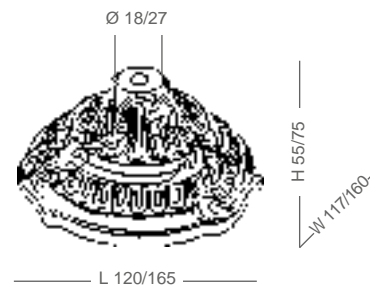

R139
L120 x W117 x H55

R138
L165 x W160 x H75

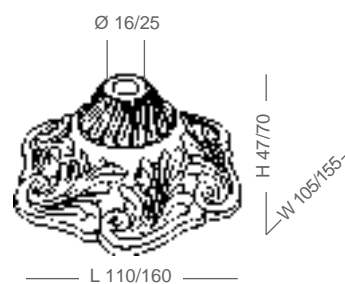

R125
L110 x W105 x H47

R121
L160 x W155 x H70

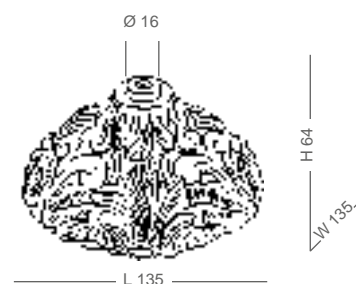

R223
L135 x W135 x H64

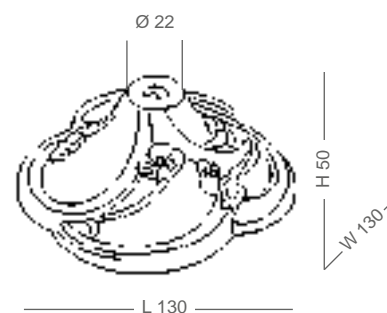

32-047
L130 x W130 x H50

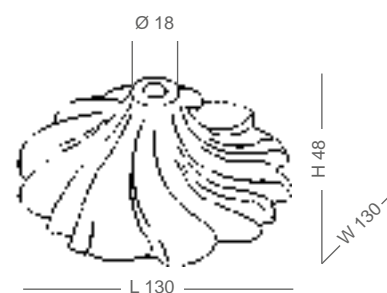

32-048
L130 x W130 x H48

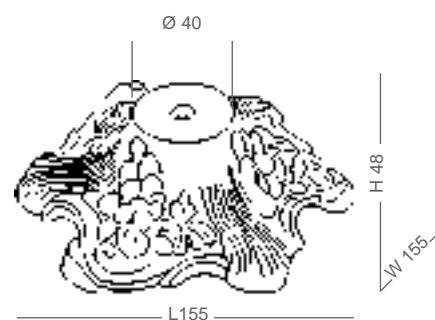

32-027
L155 x W155 x H48



R278
 L135 x W135 x H45

R279
 L185 x W185 x H65

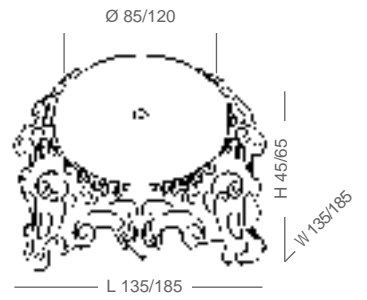

R276
 L140 x W140 x H35

R277
 L195 x W195 x H50

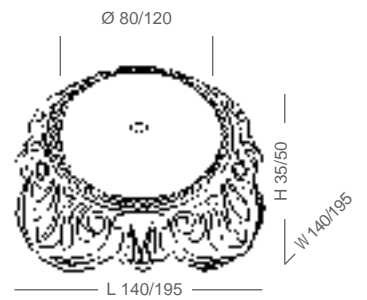

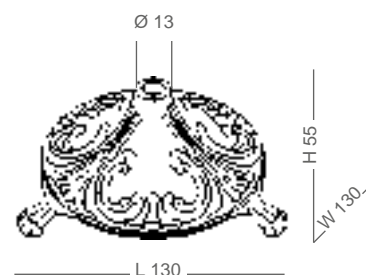

32-017
L130 x W130 x H55

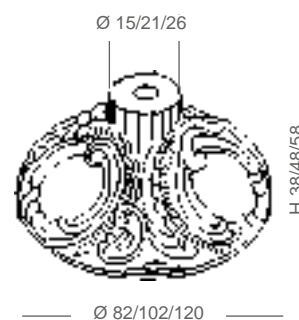

R201
Ø82 x H38

R198
Ø102 x H48

R202
Ø120 x H58



S034
Ø300 x H60

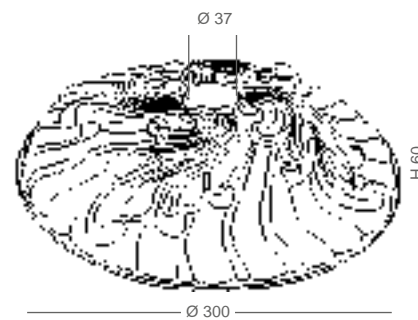

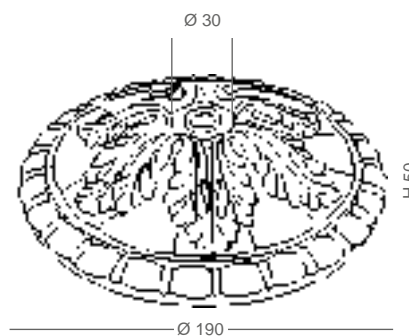

G197
Ø190 x H50

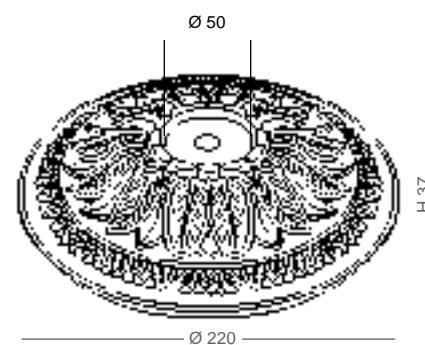

R115
Ø220 x H37

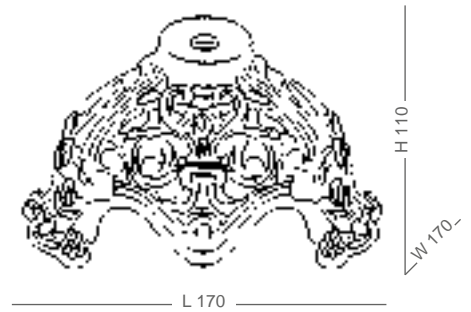

R120
 L170 xW170 x H110

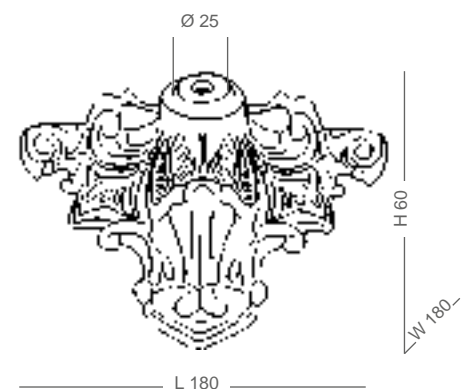

R053
 L180 x W180 x H60

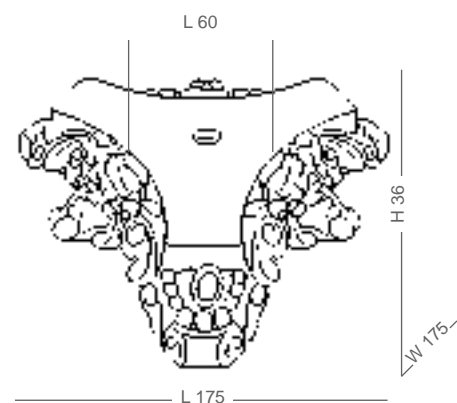

32-026
L175 x W175 x H36

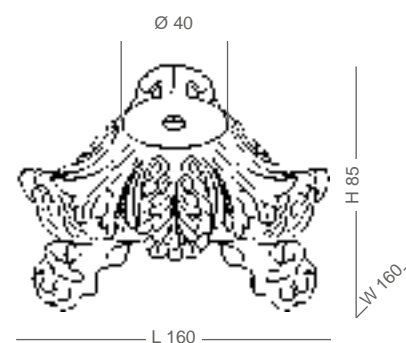

R069
L160 x W160 x H85



32-018
L100 x W100 x H45

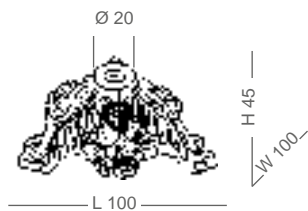

R097
L110 x W110 x H40

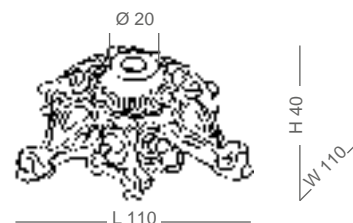

R150
L110 x W125 x H50
filetto/thread M 10/1

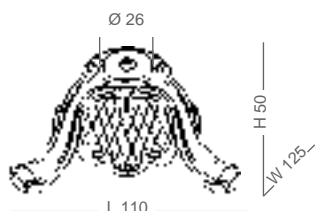

32-019
L110 x W110 x H35

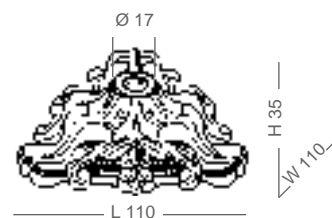



32-001
L320 x W320 x H80

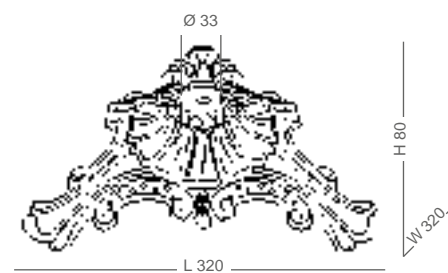

R112
L175 x W175 x H56

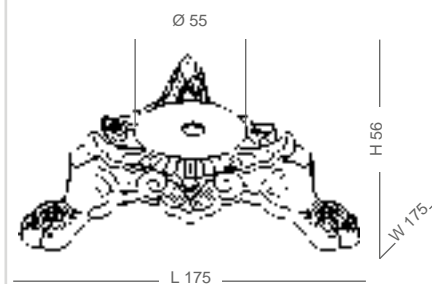



S041

L380 x W380 x H110

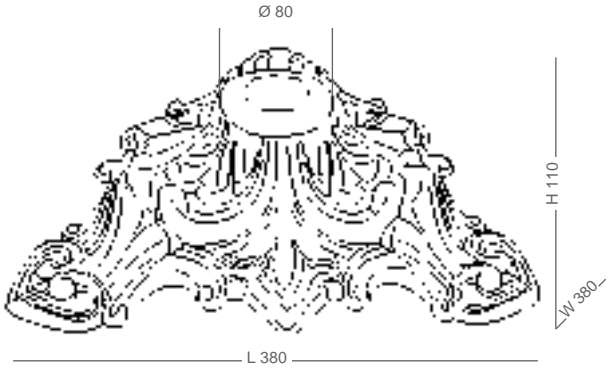



S063
L360 x W360 x H85

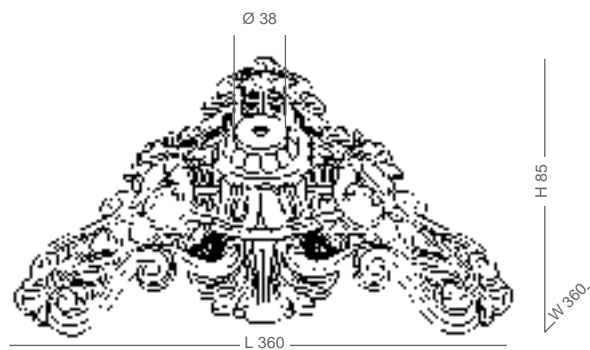

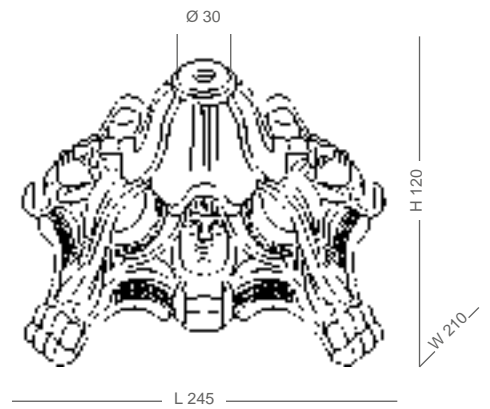

32-002
 L245 x W210 x H120

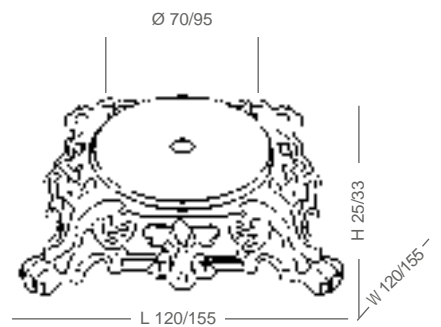

32-081
 L120 x W120 x H25

32-082
 L155 x W155 x H33

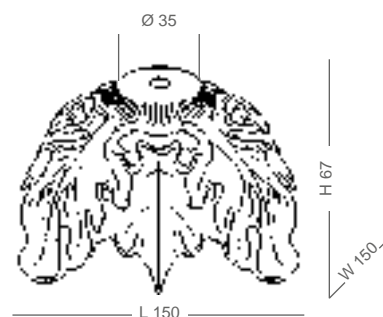

A010
L150 xW150 x H67

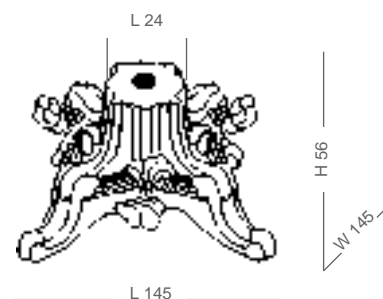

R155
L145 x W145 x H56
filetto/thread M 10/1

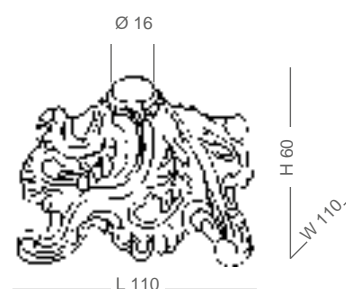

R070
L110 x W110 x H60



R152

L140 x W140 x H96

R166

L275 x W275 x H190

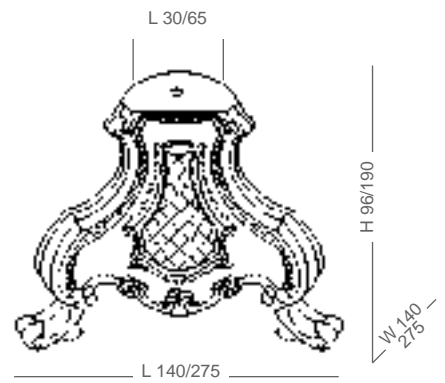



R263
L265 x W265 x H230

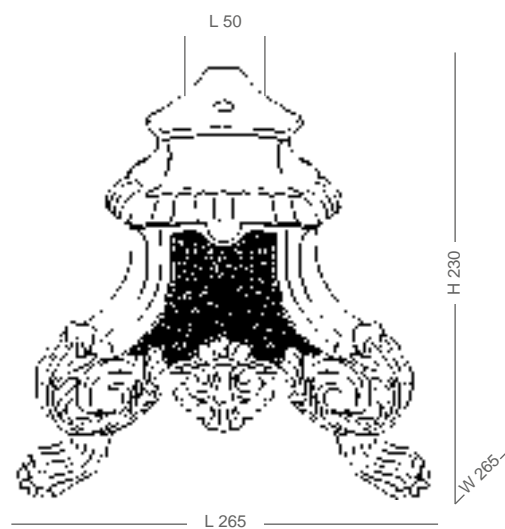

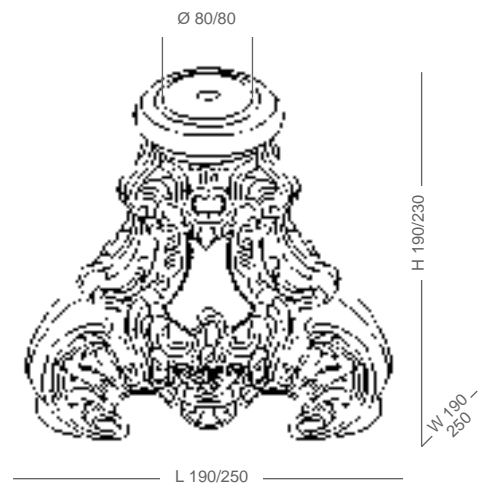

R146
L190 x W190 x H190

R145
L250 x W250 x H230

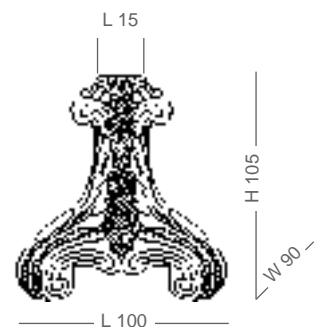

R091
L100 x W90 x H105



S058
L420 x W420 x H180

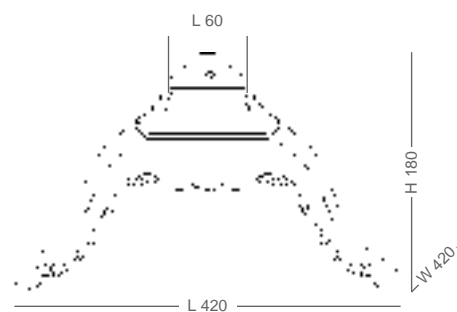

R083
L160 x W160 x H68

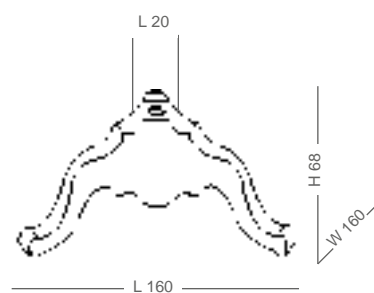



S040

L465 x W465 x H158

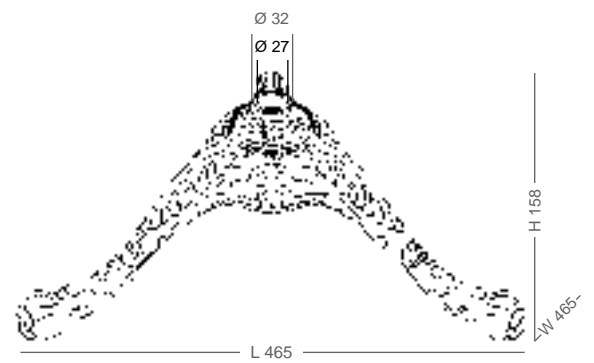



32-003

L400 x W400 x H120

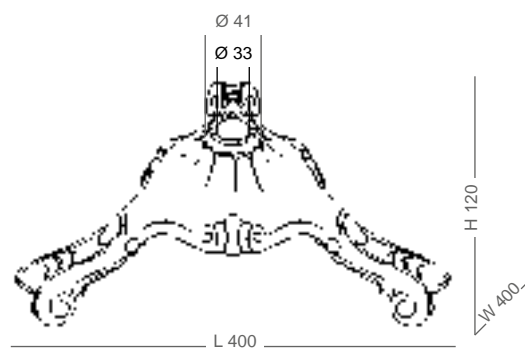



S057

L430 x W430 x H190

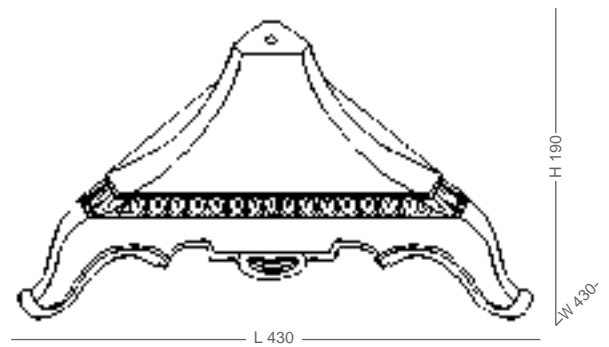



R093

L310 x W320 x H50

R251

L360 x W360 x H50

R119

L415 x W415 x H50

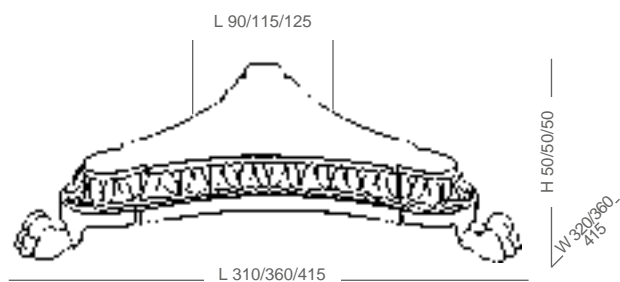



S022

L350 x W350 x H30

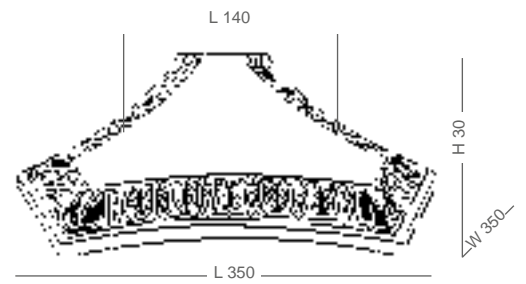



R257

L155 x W155 x H27

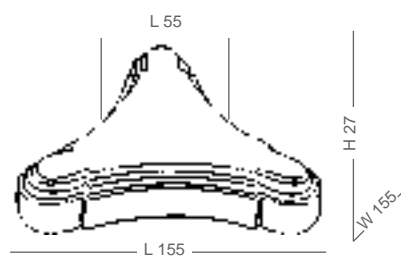

R258

L188 x W188 x H27

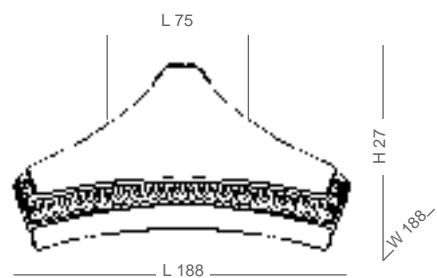

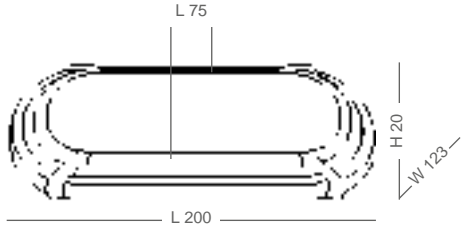

R270

L200 x W123 x H20

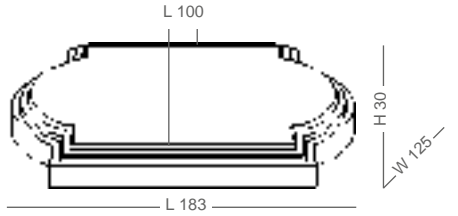

Q245

L183 x W125 x H30

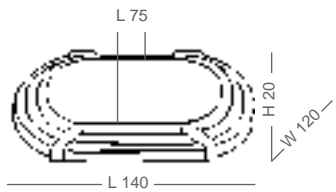

R275

L140 x W120 x H20



R266
L295 xW125 x H30

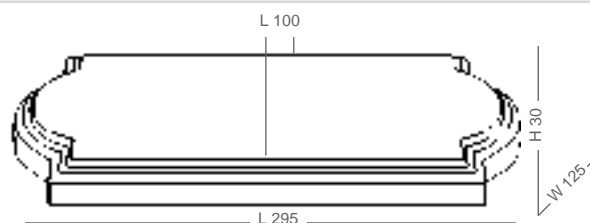

Q246
L200 x W123 x H30

R267
L270 x W164 x H30

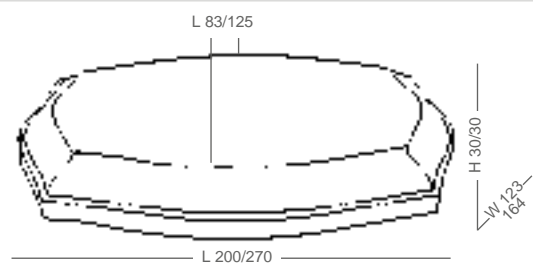



S070
 L380 x W300 x H40

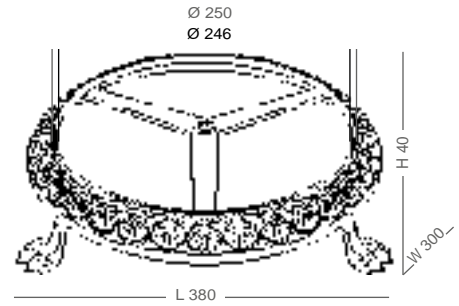

S071
 L310 x W310 x H40

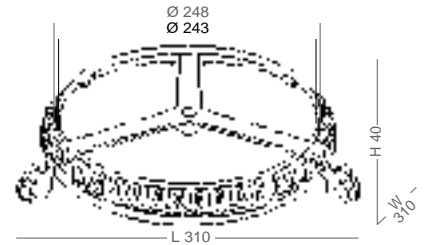



R043
L120 x W120 x H25

32-012
L160 x W160 x H26

32-014
L170 x W170 x H28

R136
L240 x W240 x H47

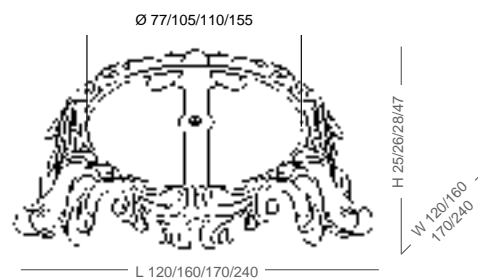

32-028
L160 x W160 x H48

32-070
L190 x W190 x H40

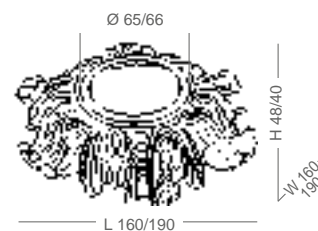

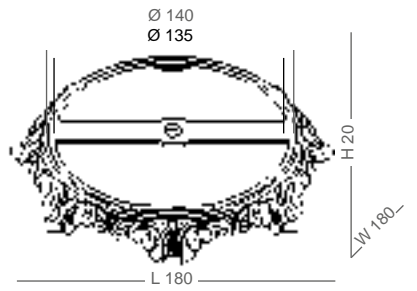

32-013
 L180 x W180 x H20

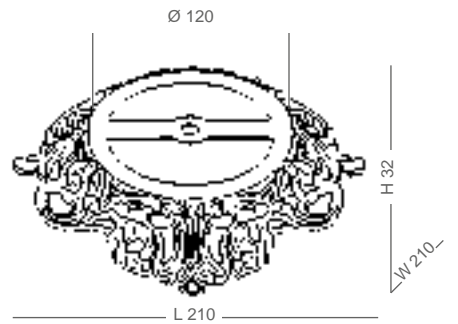

32-011
 L210 x W210 x H32



R137
L263 x W263 x H32

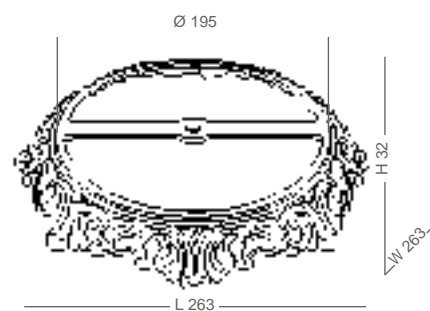

R045
L175 x W175 x H20

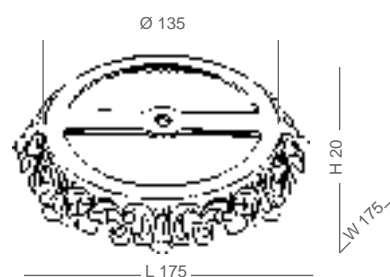



R047
L190 x W190 x H30

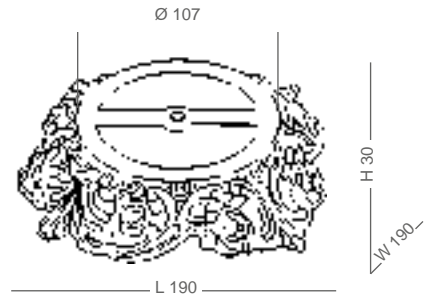

R042
L130 x W130 x H20

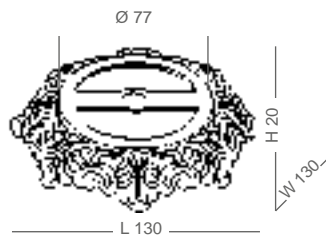

32-016
L130 x W130 x H22

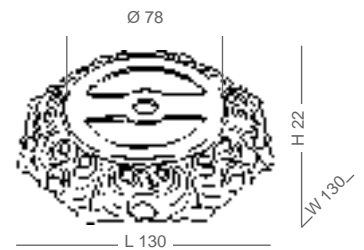



32-045
L200 x W113 x H65

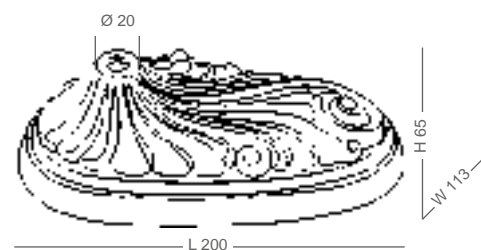

32-046
L200 x W113 x H65

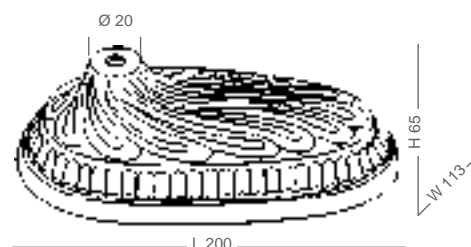

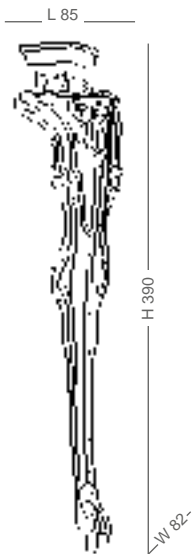

S025
L85 x W82 x H390

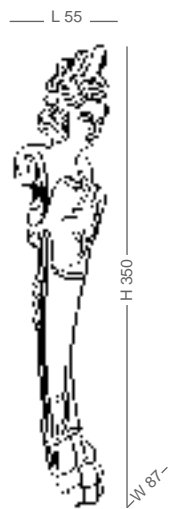

S087
L55 x W87 x H350



S083

L95 x W100 x H425

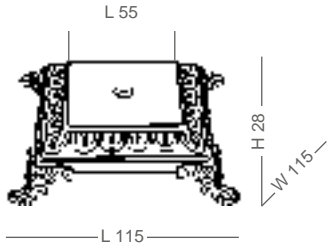

R255

L115 x W115 x H28
filetto/thread M 10/1

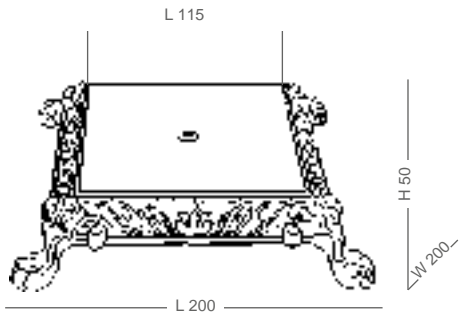

R252

L200 x W200 x H50

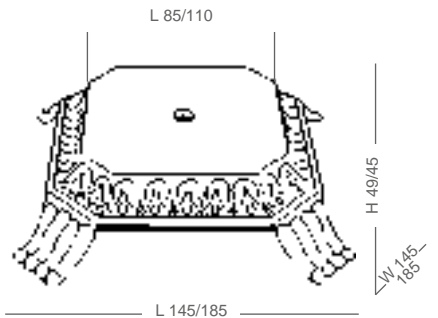

R110

L145 x W145 x H49

R133

L185 x W185 x H45

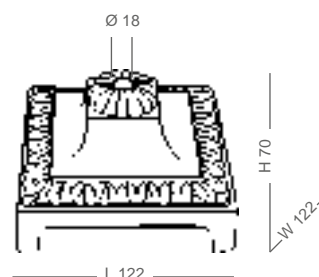

R134
L122 x W122 x H70

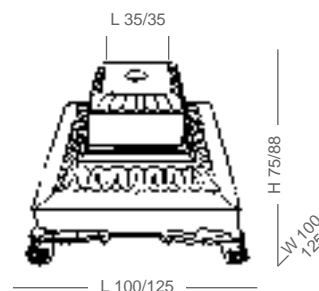

R208-20
L100 x W100 x H75

R135-20
L125 x W125 x H88

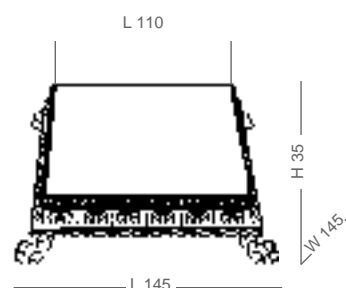

R265
L145 x W145 x H35

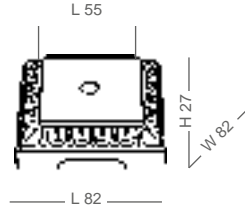

32-033
L82 x W82 x H27

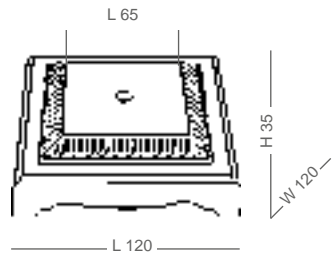

R167
L120 x W120 x H35

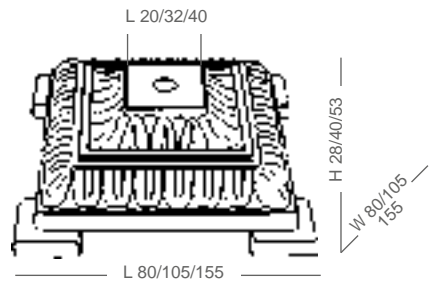

R058
L80 x W80 x H28

32-063
L105 x W105 x H40

R072
L155 x W155 x H53

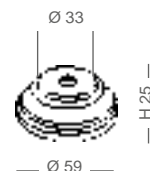

053-32-054

Ø59 x H25

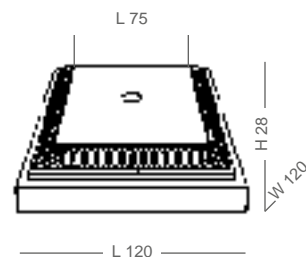

32-056

L120 x W120 x H28

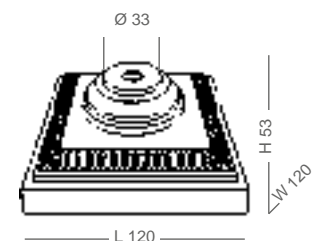

32-054

L120 x W120 x H53 composto da/composed by 32-056+053-32-054

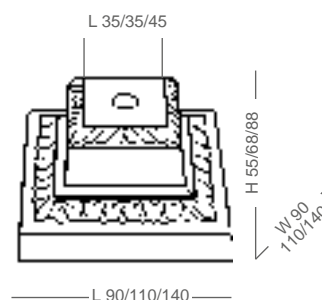

R208

L90 x W90 x H55

R135

L110 x W110 x H68

32-064

L140 x W140 x H88

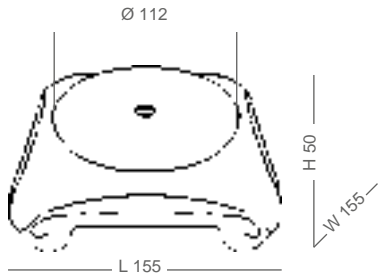

32-049
L155 x W155 x H50

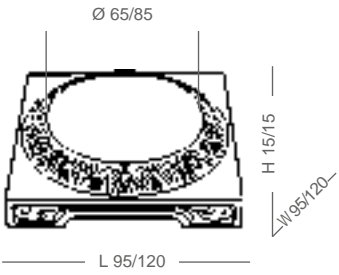

R224
L95 x W95 x H15

R225
L120 x W120 x H15

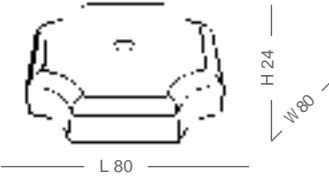

32-080
L80 x W80 x H24



R264
L120 x W120 x H22

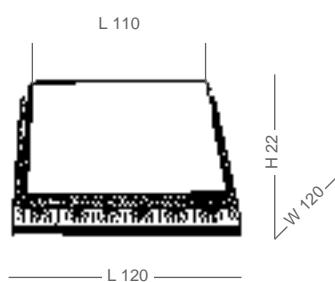

R158
L91 x W91 x H16
filetto/thread M 10/1

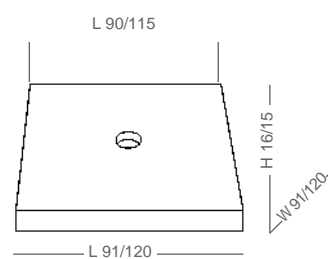

R233
L120 x W120 x H15



32-034
L110 x W110 x H15

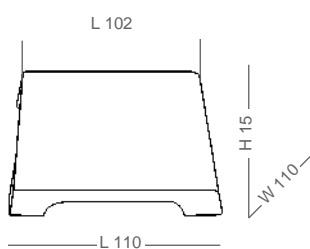

32-035
L90 x W90 x H15

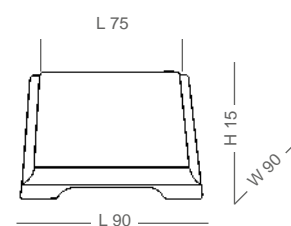

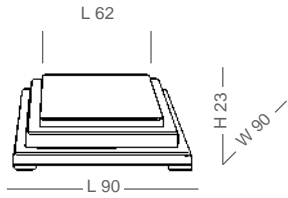

R081
L90 x W90 x H23

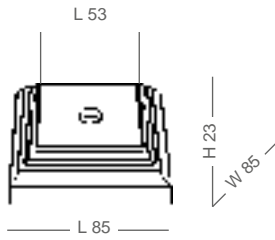

R232
L85 x W85 x H23

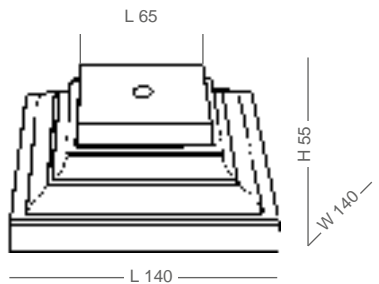

R254
L140 x W140 x H55

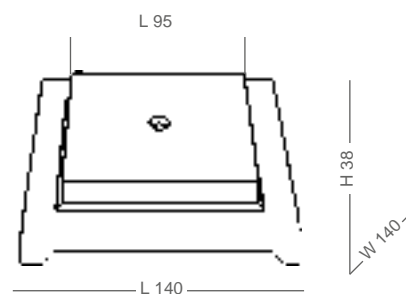

R220
L140 x W140 x H38

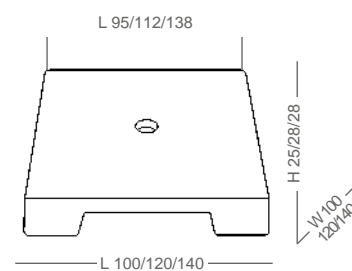

32-065
L100 x W100 x H25

R234
L120 x W120 x H28

R235
L140 x W140 x H28

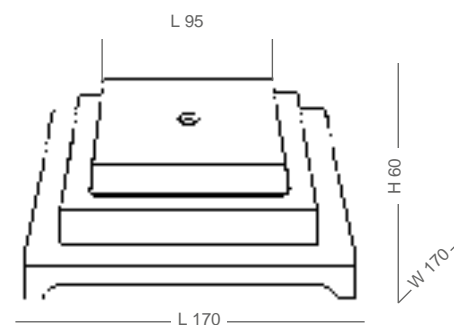

R221
L170 x W170 x H60



R245
L250 x W250 x H28

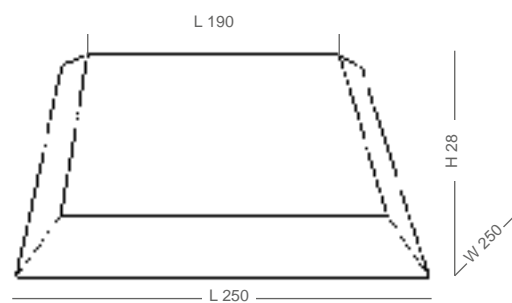

S095
L260 x W260 x H50

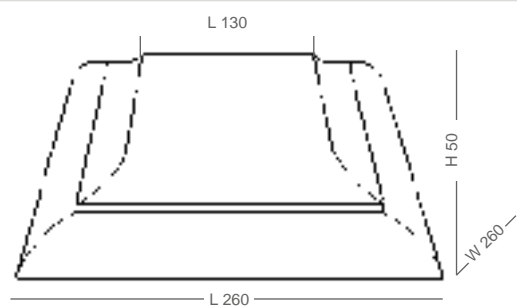



S094
L300 x W300 x H30

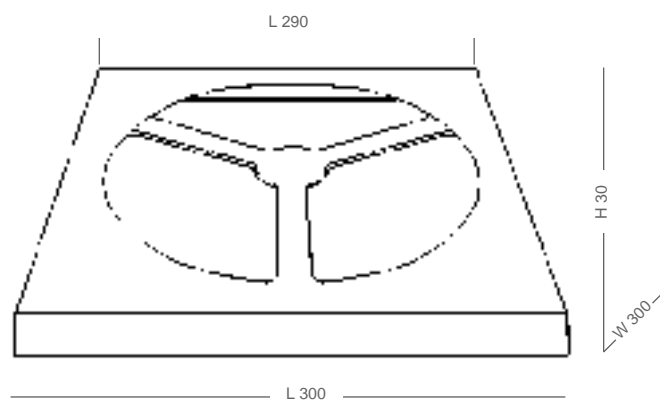

32-031
L105 x W105 x H26

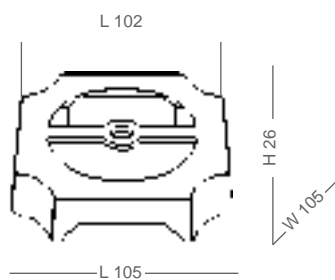

32-030
L110 x W110 x H25

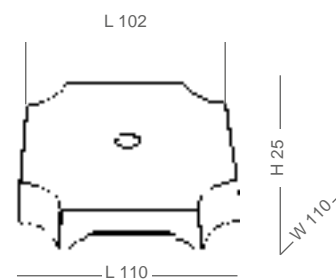

APPLIQUES PLAFONIERE FARETTI

WALL BRACKETS
CEILING LAMPS
SPOTLIGHT

Applique Wall brackets	p.439
Plafoniere Ceiling lamps	p.481
Faretti da incasso Recessed spotlight	p.493



APPLIQUES

WALL BRACKETS

Lettura misure:
Measurement legenda:

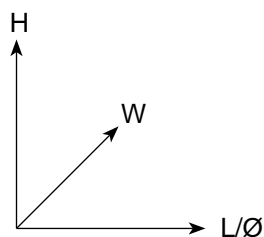

L= Lunghezza/Length
H= Altezza/Height
W= Larghezza/Width
Ø= Diametro/Diameter



Q190
L115 x W62 x H455



Q275
L95 x W35 x H510



31-016
L70 x W30 x H205



31-013
L60 x W34 x H245



31-017
L60 x W30 x H255



31-015
L60 x W32 x H230

31-012
L80 x W41 x H280



Q188
L110 x W40 x H350



Q182
L60 x W30 x H280



Q164
L65 x W33 x H245



31-008
L90 x W48 x H300

Q163
L90 x W43 x H320



31-009
L85 x W42 x H270



Q186
L80 x W39 x H330



31-018
L95 x W47 x H300



Q138
L100 x W47 x H300



Q162
L105 x W48 x H325



31-011
L100 x W53 x H260



Q131
L78 x W30 x H262



31-024
L75 x W36 x H275



Q168
L80 x W32 x H290



Q104
L58 x W32 x H265



Q145
L65 x W32 x H255



Q133
L80 x W47 x H245



Q139
L80 x W34 x H230



31-007
L65 x W28 x H270



Q146
L75 x W40 x H295



Q046
L68 x W32 x H260



Q134
L50 x W28 x H255



Q124
L50 x W24 x H270



Q123
L50 x W23 x H285



Q036
L55 x W29 x H245



31-031
L55 x W27 x H265



Q035
L65 x W27 x H240



Q001
L65 x W34 x H260



31-003
L105 x W20 x H210



31-029
L65 x W19 x H180



Q019
L90 x W33 x H220



Q183
L88 x W29 x H170



31-028
L64 x W11 x H125
foro/hole Ø11



31-026
L110 x W32 x H250



Q161
L90 x W32 x H235



Q157
L165 x W38 x H265

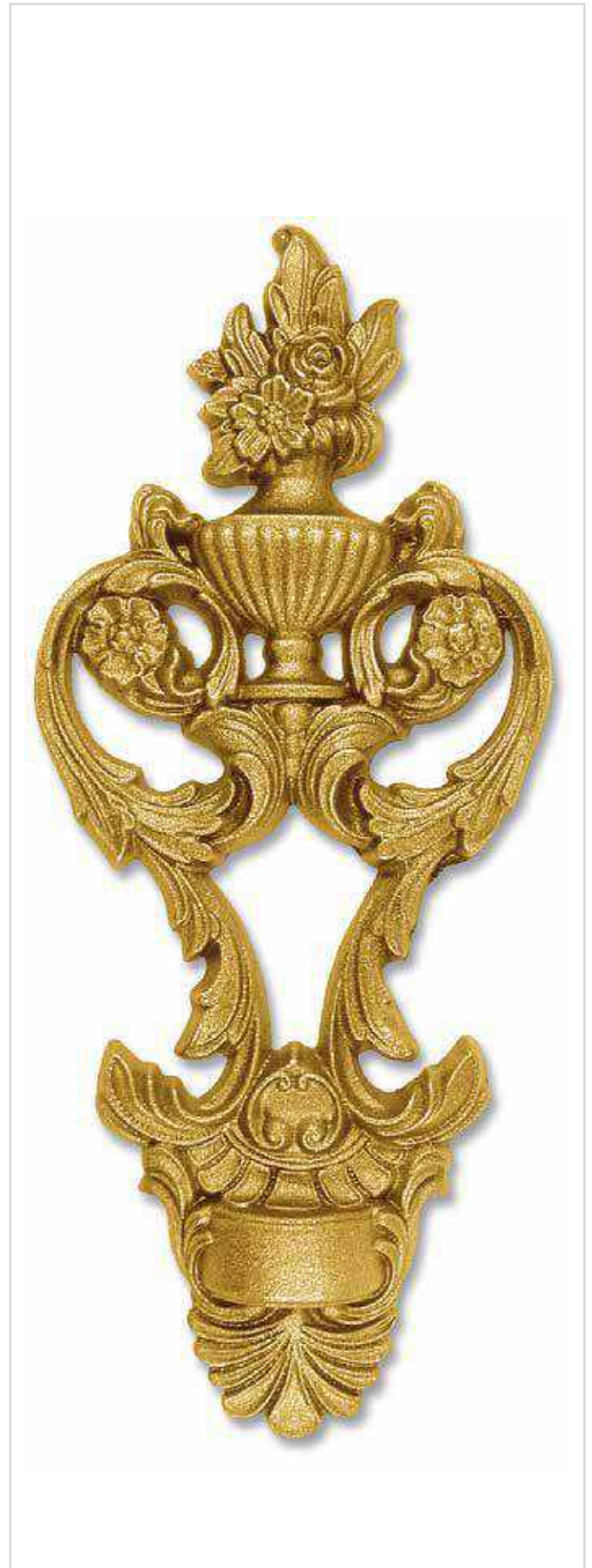

Q071
L70 x W12 x H165

Q037
L140 x W25 x H330

Q070
L90 x W16 x H220



Q021
L90 x W43 x H300



Q025 **Q017**
L60 x W20 x H195 L120 x W40 x H400



31-006

L75 x W19 x H200

31-005

L110 x W28 x H290

31-004

L150 x W38 x H395



Q003

L98 x W22 x H205

Q002

L130 x W31 x H270



Q074
L90 x W34 x H510



Q237
L90 x W13 x H180



Q238
L70 x W34 x H330



Q153
L115 x W63 x H280



Q126
L95 x W48 x H305



Q120
L205 x W21 x H400



31-046
L240 x W25 x H500



Q147
L175 x W40 x H310



Q160

L155 x W36 x H275



Q125
L300 x W29 x H370



Q040
L215 x W28 x H340



Q011
L80 x W22 x H165

Q007
L105 x W32 x H215

Q004
L130 x W32 x H270



31-025
L95 x W23 x H270



31-032
L40 x W30 x H370



31-033
L40 x W30 x H370



Q078
L60 x W23 x H205



Q080
L70 x W20 x H290



Q079
L60 x W23 x H205



31-041
L122 x W20 x H210



31-040
L120 x W20 x H200

31-039
L150 x W20 x H253



Q143
L140 x W57 x H235
filetto/thread M 10/1



Q144
L140 x W57 x H235
filetto/thread M 10/1



Q155
L200 x W92 x H265
filetto/thread M 10/1



Q193
L130 x W30 x H90



Q223
L115 x W33 x H160



Q199
L110 x W40 x H180



Q240
L125 x W31 x H200



Q198
L120 x W23 x H180



Q243
L125 x W31 x H200



Q244
L125 x W31 x H200



31-020
L95 x W18 x H180
foro/hole Ø11



31-035
Ø140 x W47
fori laterali/side holes Ø5,5



31-043
L108 x W30 x H260



Q219
L85 x W35 x H120



Q194
L82 x W15 x H115



Q068
L40 x W12 x H55

31-045
L60 x W16 x H80



31-022
L50 x W12 x H120



31-030
L70 x W20 x H155
foro/hole Ø11



31-044
L115 x W28 x H155



31-023
L90 x W19 x H130



31-034

L80 x W20 x H190



Q151

L55 x W28 x H110



31-034-10

L75 x W10 x H20

Staffa per / Stirrup for 31-034



31-021
L65 x W18,5 x H165



31-021-01
L65 x W18,5 x H165



31-021-10 Staffa per / *Stirrup for 31-021-01*
L60 x W10 x H15
filetto/thread M4



31-047
Ø80 x H20

31-048
Ø100 x H20

31-049
Ø120 x H20



31-047-10
L77 x W10 x H48
Staffa per / Stirrup for 31-047

31-048-10
L97 x W10 x H58
Staffa per / Stirrup for 31-048

31-049-10
L115 x W10 x H68
Staffa per / Stirrup for 31-049



Q239
Ø85 x H48



Q239-10
L75 x W6,5 x H10
Staffa per / Stirrup for Q239



PLAFONIERE

CEILING LAMPS

Lettura misure:
Measurement legenda:

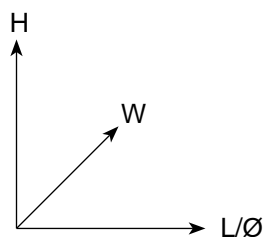
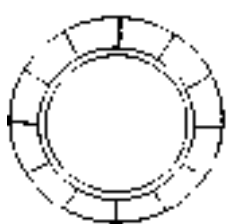

L= Lunghezza/Length
H= Altezza/Height
W= Larghezza/Width
Ø= Diametro/Diameter



34-002
Ø280 x W47
sede interna/internal housing Ø180

34-001
Ø360x W47
sede interna/internal housing Ø230



34-003

Ø320 x W47

sede interna/internal housing Ø180



Z135

Ø275 x W43

sede interna/internal housing Ø180

Z133

Ø330x W49

sede interna/internal housing Ø230



34-005

Ø300 x W20

Ø interno/inside Ø 185

sede interna/internal housing Ø200



34-004

Ø300 x W20

Ø interno/inside Ø 190



Z309

Ø470 x W56

Ø interno/inside Ø 282

sede interna/internal housing Ø301

2 pezzi saldati/2 pcs joined

Z305

Ø600 x W60

Ø interno/inside Ø 375

sede interna/internal housing Ø401

2 pezzi saldati/2 pcs joined



Z307

Ø470 x W54

Ø interno/inside Ø 282

sede interna/internal housing Ø301

2 pezzi saldati/2 pcs joined

Z303

Ø600 x W57

Ø interno/inside Ø 375

sede interna/internal housing Ø401

2 pezzi saldati/2 pcs joined



Z310

L470x W56 x H235
 Ø interno/inside Ø 282
 sede interna/internal housing Ø301

Z306

L600 x W60 x H300
 Ø interno/inside Ø 375
 sede interna/internal housing Ø401



Z308

L470x W56 x H235
 Ø interno/inside Ø 282
 sede interna/internal housing Ø301

Z304

L600 x W60 x H300
 Ø interno/inside Ø 375
 sede interna/internal housing Ø401



Z058

Ø400 x W78

Ø interno/inside Ø 240



34-015
Ø500 x Ø403 int. x H53

34-014
Ø400 x Ø303 int. x H45



34-015-10
Ø480x H1,5

34-014-10
Ø380x H1,5



34-025

Ø500 x Ø403 int. x H53

34-024

Ø400 x Ø303 int. x H45



34-015-10

Ø480x H1,5

34-014-10

Ø380x H1,5



FARETTI DA INCASSO

RECESSED SPOTLIGHT

Lettura misure:
Measurement legenda:

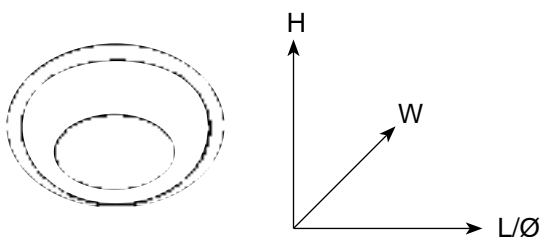

L= Lunghezza/Length
H= Altezza/Height
W= Larghezza/Width
Ø= Diametro/Diameter

STILETTO

E' un prodotto pensato per l'illuminazione di ambienti interni e dispone di caratteristiche tecniche finalizzate per l'incasso a parete o a soffitto.

E' possibile richiedere la Brochure Stiletto, che presenta il prodotto completo e pronto per l'installazione, scegliendo tra nove diverse finiture

STILETTO

Stiletto is a product that was designed for indoor lighting and has specifications intended for recessed wall or ceiling fittings.

It is possible to request the Stiletto Brochure, which shows the complete item ready for the installation, choosing under nine different finishes



Bronzo Graffiato
Scatched Bronze



Cromo
Chrome



Ottone Lucido
Shiny Brass



Oro 24
Gold 24



Peltro
Pewter



Rame Antico
Ancient Copper



Rame Dark
Dark Copper



Bianco Dirty
Dirty White



Bianco Lucido
Shiny White





35-002
L100 x W100 x H40 · foro/hole Ø50



35-001
Ø100 x H45 · foro/hole Ø50



35-003
Ø100 x H45 · foro/hole Ø50



F1273-08-039
Molla per - *Clip for 35-001 / 35-002 / 35-003*

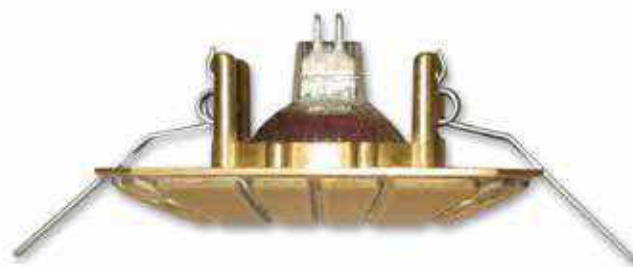

F1273-08-038
Clip per - *Clip for 35-001 / 35-002 / 35-003*



Esempio assemblato - *Assembled example*



35-004

Ø100 x H45 · foro/hole Ø50



35-005

Ø100 x H45 · foro/hole Ø50

35-008

Ø160 x H60 · foro/hole Ø50



35-006

L100 x W100 x H45 · foro/hole Ø50



35-007

L100 x W100 x H45 · foro/hole Ø50



F1273-08-030 Molla per - *Clip for* 35-004 / 35-005 / 35-006 / 35-007 / 35-008
L75 x W6,5 x H10

ARTICOLI VARI
VARIOUS ITEMS

Portalumi	499	T007	509	F092	513	Capitelli	527
		T009	511	H837	516		
33-001	499	T017	511	N046	513	40-050	529
33-002	499	T021	509	N047	513	40-051	529
33-003	499	T022	509	U011	515	40-052	529
33-004	499	T026	510	U012	515	40-053	529
		T028	510	U013	515	40-060	529
Alogene	501			U014	515	40-061	529
		Ornamenti	513	U015	515	40-062	529
F481	501			Z025	517	40-063	529
Q178	502	050-0454	524	Z027-F	517	S018	531
Q180	503	050-0455	524	Z031	517	S072	530
Q199	503	051-0091	524	Z044	523	S084	531
Q207	502	051-0110	524	Z062	523	S085	530
Q208	501	051-0111	524	Z066	514	S086	531
Q210	501	29-093	515	Z067	514	S088	530
Z152	502	29-097	514	Z080	517	S089	530
Z152	502	30-018	520	Z104	517	S090	530
		40-003	513	Z105	521	S091	530
Cornici	505	40-005	513	Z111	514	S092	531
		40-014	518	Z112	514	S093	531
29-138	506	40-015	518	Z155	519	S098	530
40-037	507	40-016	518	Z162	519	S099	530
40-038	505	40-017	518	Z275	516	S100	530
40-070	507	40-018	518	Z276	516	S101	531
N022	506	40-024	519	Z277	516	X766	529
N056	507	40-027	518	Z285	514	Z096	529
N059	505	40-028	518	Z286	514	Z246	529
N062	505	40-029	518	Z287	514	Z252	527
V060	506	40-030	518	Z288	514	Z253	527
V094	507	40-031	519	Z289	516	Z254	528
V101	505	40-032	519	Z290	516	Z255	528
V104	506	40-033	519	Z291	516	Z257	527
		40-034	519	Z296	520	Z258	528
Putti	509	40-034-02	519	Z297	520	Z259	528
		40-035	522	Z298	520	Z283	528
40-008	510	40-036	522	Z301	516	Z284	528
40-009	510	40-040	519	Z302	517		
40-011	511	40-065	517	Z311	516		
40-012	511	40-081	517	Z312	516		
40-013	511	40-083	517	Z313	516		
T006	509	F089	513				

ARTICOLI VARI E CAPITELLI VARIOUS ITEMS & CAPITALS

Portalumi Lamps holder	p.499
Alogene Halogen lights	p.501
Cornici Frames	p.505
Putti Cherubs	p.509
Ornamenti Decorative items	p.513
Capitelli Capitals	p.527



PORTALUMI LAMPS HOLDER

Lettura misure:
Measurement legenda:

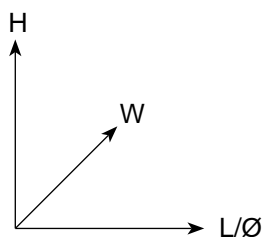

L= Lunghezza/Length
H= Altezza/Height
W= Larghezza/Width
Ø= Diametro/Diameter



33-003

L110 x W21 x H145
filetto/thread M 10/1

33-002

L130 x W23 x H190
filetto/thread M 10/1

33-001

L160 x W24 x H240
filetto/thread M 10/1

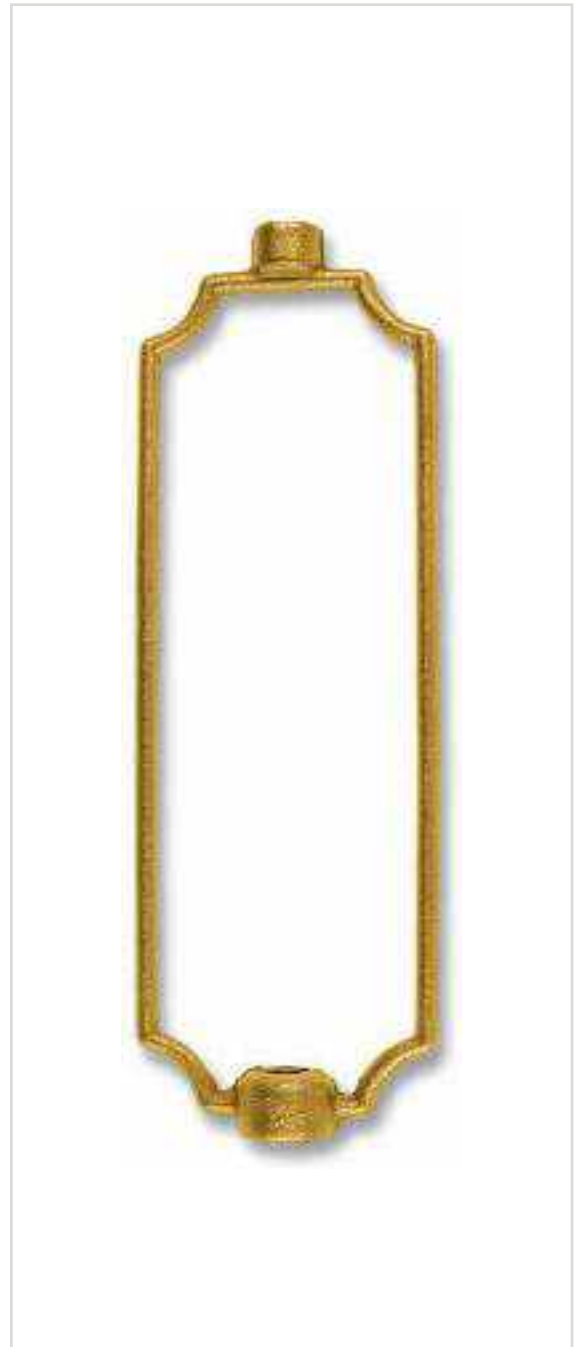

33-004

L62 x W19 x H182
filetto/thread M 10/1



ALOGENE HALOGEN LIGHTS

Lettura misure:
Measurement legenda:

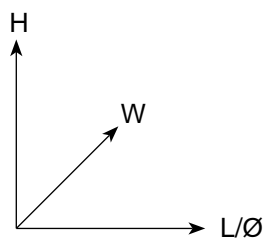

L= Lunghezza/Length
H= Altezza/Height
W= Larghezza/Width
Ø= Diametro/Diameter



F481
Ø250 x W54



Q210
L150 x W320 x W60



Q208
L260 x W100 x H120



Q207
L265 x W95 x H160



Z152
L25 x W16 x H63



Q178
L210 x W80 x H90



Z152
L25 x W16 x H63



Q180
L235 x W50 x H125



Q199
L180 x W40 x H110



CORNICI

FRAMES

Lettura misure:
Measurement legenda:

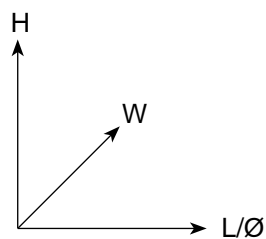

L= Lunghezza/Length
H= Altezza/Height
W= Larghezza/Width
Ø= Diametro/Diameter



N059
L400 x W3 x H30



V101
L350 x W5 x H35



40-038
L320 x W23 x H105



N062
L420 x W10 x H140



29-138
L260 x W10 x H35



V104
L185 x W5 x H55



N022
L305 x W5 x H52

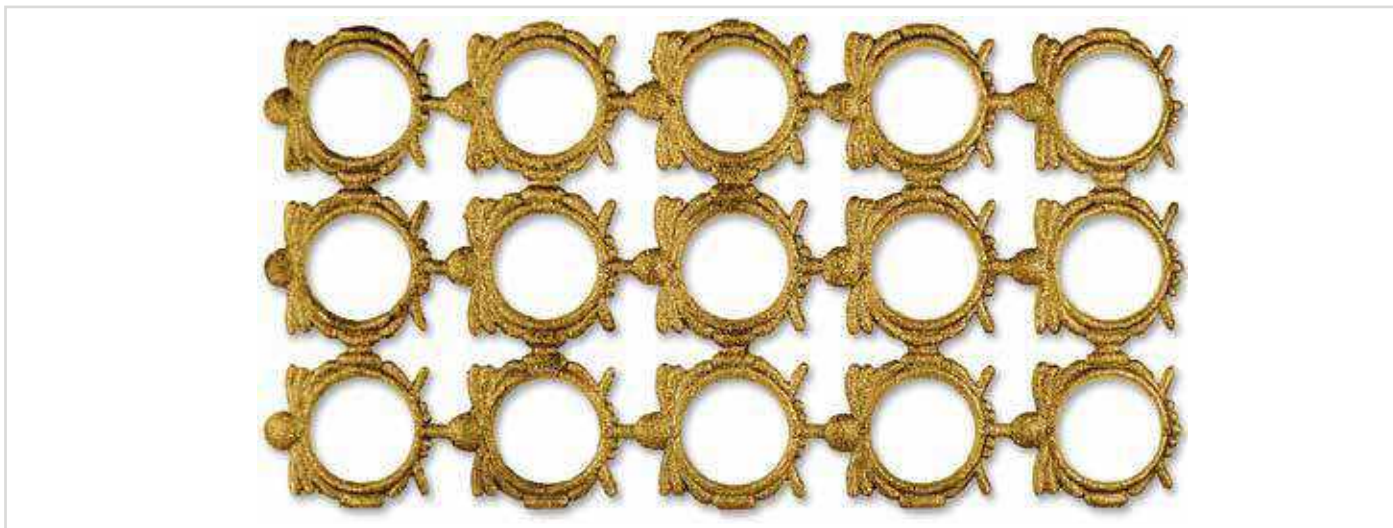

V060
L250 x W4 x H135



N056

L600 x W5 x H52



40-070

L775 x W18 x H80



40-037

L415 x W4 x H70



V094

L510 x W15 x H140



PUTTI CHERUBS

Lettura misure:
Measurement legenda:

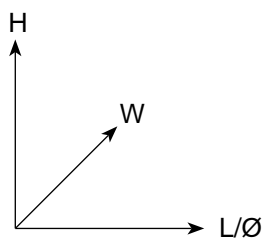

L= Lunghezza/Length
H= Altezza/Height
W= Larghezza/Width
Ø= Diametro/Diameter



T007
L90 x W60 x H180

T006
L120 x W70 x H245



T022
L90 x W60 x H180

T021
L120 x W70 x H245



T026
L125 x W70 x H170



T028
L125 x W70 x H170



40-008
L80 x W45 x H150
filetto/thread M 10/1



40-009
L80 x W45 x H150
filetto/thread M 10/1



T009
L50 x W35 x H155
filetto/thread M 10/1



40-011
L50 x W25 x H100



T017
L55 x W30 x H105



40-012
L40 x W11 x H70



40-013
L35 x W15 x H55



ORNAMENTI

DECORATIVE ITEMS

Lettura misure:
Measurement legenda:

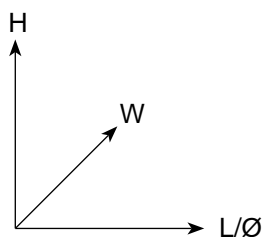

L= Lunghezza/Length
H= Altezza/Height
W= Larghezza/Width
Ø= Diametro/Diameter



F092

L95 x W85 x H13
Ø interno/inside Ø60



F089

Ø115 x H15
Ø interno/inside Ø60



N047

Ø115 x H21
Ø interno/inside Ø58



N046

Ø135 x H13
Ø interno/inside Ø75



40-005

Ø90 x H10
Ø interno/inside Ø77



40-003

Ø95 x H8
Ø interno/inside Ø62



Z111
L85 x W17 x H95

Z112
L125 x W26 x H140



Z066
L100 x W19 x H80

Z067
L125 x W22 x H98



Z286
L45 x W45 x H45
2 pezzi saldati/2 pcs joined

Z285
L60 x W60 x H60
2 pezzi saldati/2 pcs joined



Z288
L45 x W22 x H45
1 pezzo/1 piece

Z287
L60 x W30 x H60
1 pezzo/1 piece



29-097
L100 x W8 x H50





U013
L55 x W23 x H145
filetto/thread M 10/1

U014
L80 x W32 x H200
filetto/thread M 10/1 + M 13/1

U015
L95 x W42 x H260
filetto/thread M 10/1 + M 13/1



U012
L90 x W12 x H110
filetto/thread M 10/1

U011
L60 x W8 x H80
filetto/thread M 10/1



29-093
L80 x W14 x H80



H837
L310 x L34 x H73



Z289
L25 x W25 x H50

Z291
L46 x W46 x H95



Z275
L25 x W25 x H42

Z277
L46 x W46 x H80

Z290
L34 x W34 x H75

Z276
L34 x W34 x H57



Z313
L25 x W25 x H3
per art/for art. Z289/Z275

Z311
L45 x W45 x H3
per art/for art. Z291/Z277



Z301
L50 x W20 x H20

Z312
L30 x W30 x H3
per art/for art. Z290/Z276



Z302
L45 x W50 x H65



Z027-F
L55 x W25 x H20



Z031
L48 x W27 x H60



40-065
L47 x W47 x H95



Z104
L55 x W50 x H25



Z080
L70 x W28 x H85



40-083
L10 x W13 x H10



Z025
L35 x W12 x H12



40-081
L43 x W34 x H16



40-014
L75 x W19 x H80
foro passante Ø12
all through hole Ø12



40-015
L40 x W19 x H70
foro passante Ø12
all through hole Ø12



40-017
L23 x W18 x H70
foro passante Ø10,5
all through hole Ø10,5



40-016
L30 x W19 x H55
filetto/thread M 10/1
foro/hole Ø10,5



40-018
L20 x W16 x H40
filetto/thread M 10/1
foro/hole Ø10,5



40-027
L70 x W3 x H45



40-028
L80 x W3 x H28



40-030
L65 x W3 x H17



40-029
L65 x W3 x H20



40-034

L20 x W18 x H50
filetto/thread M 10/1
foro per perno/fixing hole Ø6

40-034-02

L20 x W18 x H50
filetto/thread M 10/1
foro per perno/fixing hole Ø5



40-032

L20 x W17 x H60
filetto/thread M 10/1
foro per perno/fixing hole Ø6



40-024

L28 x W18 x H56



40-033

Ø40 x H10
foro per perno/fixing hole Ø5



40-031

Ø65 x H10
foro per perno/fixing hole Ø6



40-040

Ø65 x H37
filetto/thread M 10/1



Z162

L23 x W36 x H58
smontato/not assembled



Z155

L60 x W36 x H58
smontato/not assembled





Z296

L85 x W24 x H90
2filetti/2threading M 10/1

Z297

L115 x W26 x H125
2filetti/2threading M 10/1

Z298

L170 x W30 x H185
2filetti/2threading M 10/1



30-018

Ø310 x H22
sede interna/internal housing Ø305



Z105
L320 x W25 x H600

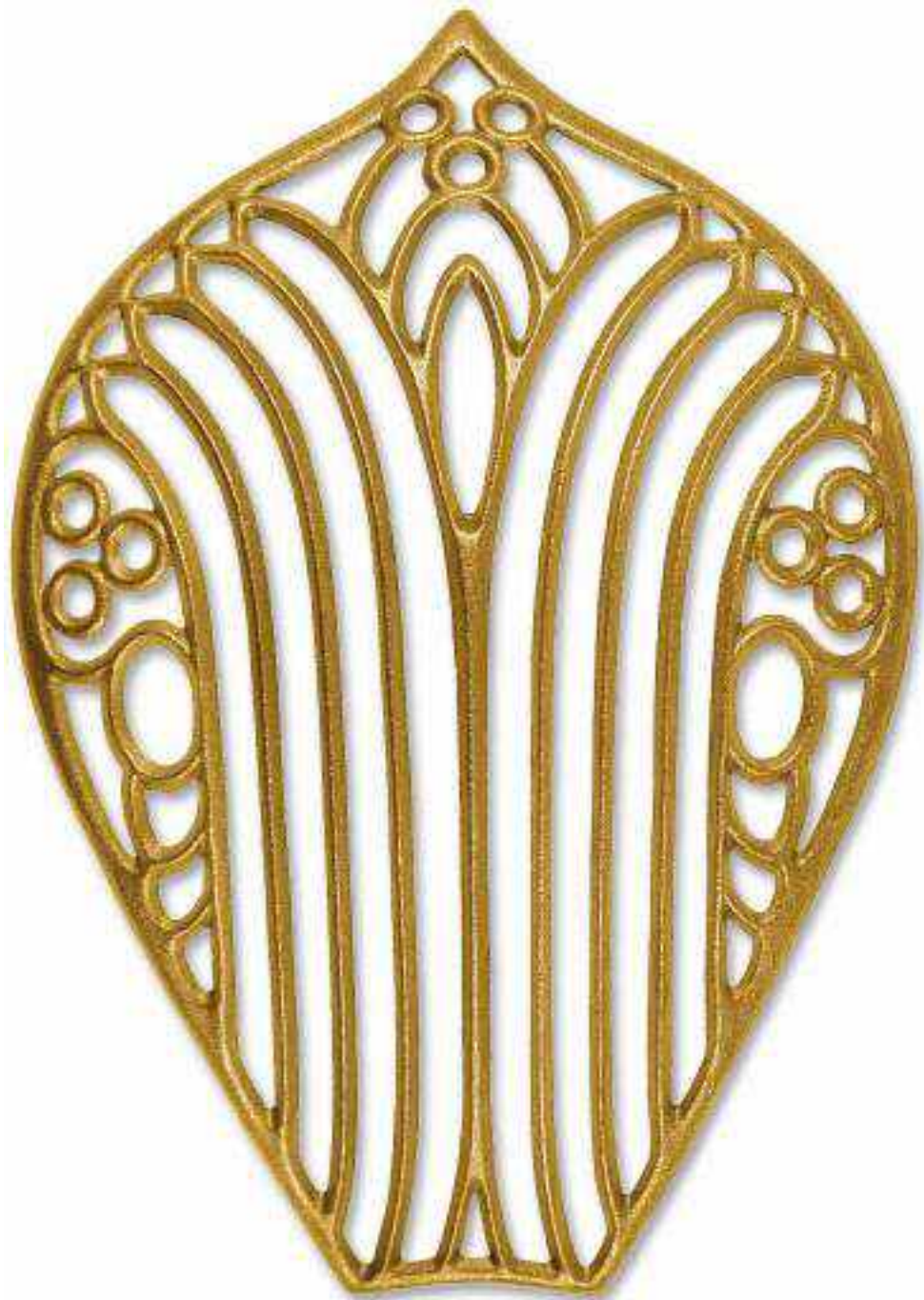

40-036
L120 x WL25 x H160

40-035
L185 x W38 x H250



Z044
L105 x W13 x H260



Z062
L90 x W14 x H40



050-0454

Ø25x H85

Tubo di copertura per portalamпада

Lampholder cover tube



050-0455

Ø12 x H20

Distanziale per ornamenti braccio

Spacer for arm ornaments



051-0110

L1 300 x L2 205 x H90 x Ø9

Tubo interno per braccio piccolo

Small arm internal tube

051-0111

L1 360 x L2 280 x H110 x Ø9

Tubo interno per braccio grande

Long arm internal tube



051-0091

Ø36 x H29

Copertura per portalamпада

Lampholder cover







CAPITELLI

CAPITALS

Lettura misure:
Measurement legenda:

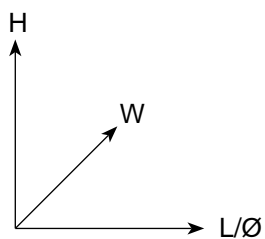

L= Lunghezza/Length
H= Altezza/Height
W= Larghezza/Width
Ø= Diametro/Diameter



Z252

L220 x W220 x H185

p. appoggio sotto/lower support Ø145

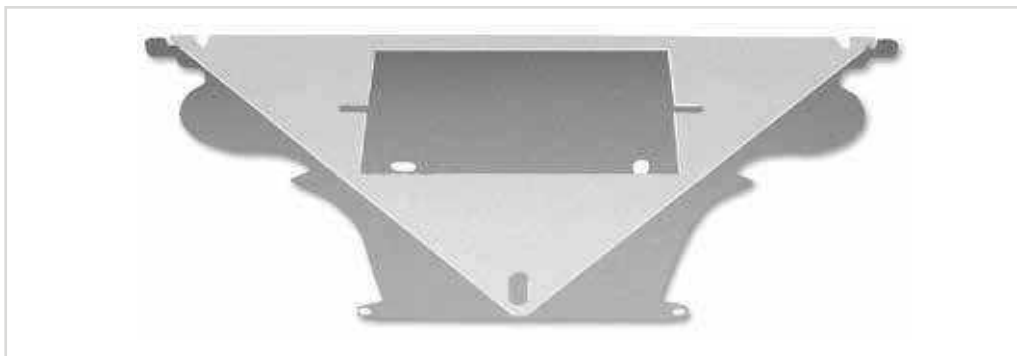

Z257

L280 x W140 x H182



Z253

L285 x W142 x H185

1/2 pezzo / 1/2 piece

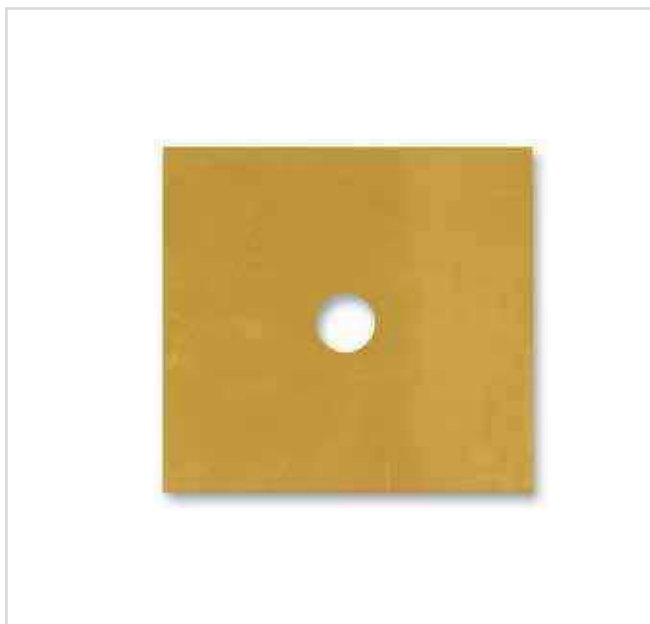

Z259 (per/for Z255)
L75 x W1,5 x H75 - foro/hole Ø11

Z258 (per/for Z254)
L90 x W1,5 x H90 - foro/hole Ø11



Z284 (per/for Z283)
L40 x W1,5 x H40 - foro/hole Ø10,5



Z255
L88 x W88 x H72
foro/hole Ø10,5
p. appoggio sotto/lower support Ø60

Z254
L103 x W103 x H87
foro/hole Ø10,5
p. appoggio sotto/lower support Ø70



Z283
L50 x W50 x H50
foro/hole Ø10,5
p. appoggio sotto/lower support Ø30



40-060 (per/for 40-051)
Ø28 x 3



X766
L55 x W1,5 x H55
foro/hole Ø11



40-061 (per/for 40-051)
L60 x W3 x H60

40-063 (per/for 40-053)
L90 x W3 x H90

40-062 (per/for 40-052)
L65 x W3 x H65



Z096
L60 x W60 x H48
foro interno/internal hole Ø10,5
p. appoggio sotto/lower support Ø35



40-050
L40 x W40 x H32
p. appoggio sotto/lower support Ø30

40-052
L75 x W75 x H60
p. appoggio sotto/lower support Ø50

40-051
L58 x W58 x H47
p. appoggio sotto/lower support Ø40

40-053
L90 x W90 x H70
p. appoggio sotto/lower support Ø60



Z246
L60 x W60 x H48
filetto interno/internal thread M 10/1
p. appoggio sopra/upper support Ø45
p. appoggio sotto/lower support Ø30



S100

L70 x W70 x H28
 foro/hole Ø10,5
 p. appoggio sopra/upper support Ø60
 fresato/milled



S091

L70 x W70 x H34
 foro/hole Ø10,5
 p. appoggio sopra/upper support Ø60
 fresato/milled



S090

L72 x W72 x H34
 foro/hole Ø10,5
 p. appoggio sopra/upper support Ø62



S099

L60 x W60 x H28
 foro/hole Ø10,5
 p. appoggio sopra/upper support Ø50
 fresato/milled



S089

L60 x W60 x H34
 foro/hole Ø10,5
 p. appoggio sopra/upper support Ø50
 fresato/milled



S088

L62 x W62 x H34
 foro/hole Ø10,5
 p. appoggio sopra/upper support Ø52



S098

L50 x W50 x H31
 foro/hole Ø10,5
 p. appoggio sopra/upper support Ø40
 fresato/milled



S085

L50 x W50 x H31
 foro/hole Ø10,5
 p. appoggio sopra/upper support Ø40
 fresato/milled



S072

L52 x W52 x H31
 foro/hole Ø10,5
 p. appoggio sopra/upper support Ø42



S101

L33 x W33 x H20

foro/hole Ø11

p. appoggio sopra/upper support Ø26

p. appoggio sotto/lower support Ø26

fresato/milled



S086

L33 x W33 x H20

foro/hole Ø11

p. appoggio sopra/upper support Ø26

p. appoggio sotto/lower support Ø26



S093

L52 x W52 x H14

p. appoggio sopra/upper support Ø42

S092

L70 x W70 x H14

p. appoggio sopra/upper support Ø55



S018

L52 x W52 x H45

foro/hole Ø10,5

p. appoggio sotto/lower support Ø42



S084

L50 x W50 x H45

foro/hole Ø10,5

p. appoggio sotto/lower support Ø40

fresato/milled



050-0454	524	10-008	17	10-028-04	17	10-052-01	15	12-026	25	14-006	62
050-0455	524	10-009	17	10-028-05	17	10-052-04	15	12-027	25	14-008	96
051-0091	524	10-010	18	10-028-06	17	10-052-10	15	12-028	25	14-009	63
051-0110	524	10-010-01	18	10-028-09	17	10-053	15	12-029	25	14-010	63
051-0111	524	10-010-04	18	10-029	17	10-053-01	15	12-030	26	14-011	66
053-32-054	429	10-011	18	10-029-01	17	10-053-02	15	12-031	26	14-012	66
096-VI01	227	10-011-01	18	10-029-02	17	10-053-03	15	12-032	25	14-013	64
096-VI01-01	227	10-011-04	18	10-029-03	17	10-054	16	12-033	26	14-014	64
096-VI01-02	227	10-013	16	10-031	23	10-054-01	16	12-035	25	14-015	64
096-VI01-03	229	10-013-01	16	10-031-01	23	10-054-02	16	12-036	26	14-016	64
096-VI01-05	229	10-014	15	10-031-02	23	10-054-03	16	12-037	26	14-017	64
096-VI02	224	10-014-01	15	10-031-03	23	11-001	31	13-001	44	14-018	64
096-VI03	225	10-014-02	15	10-032	19	11-002	31	13-002	44	14-019	64
096-VI04	225	10-014-03	15	10-032-01	19	11-003	31	13-003	44	14-020	64
096-VI05	224	10-015	16	10-032-02	19	11-004	31	13-004	42	14-021	65
096-VI06	226	10-015-01	16	10-032-03	19	11-005	32	13-005	40	14-022	65
096-VI06-01	226	10-016	15	10-033	21	11-006	32	13-006	43	14-025	71
096-VI06-02	226	10-016-01	15	10-033-01	21	11-007	35	13-007	39	14-026	71
096-VI06-03	228	10-018	15	10-034	18	11-008	35	13-008	40	14-027	71
096-VI07	224	10-018-01	15	10-034-01	18	11-009	33	13-009	40	14-032	99
096-VI08	225	10-018-04	15	10-035	23	11-010	32	13-010	44	14-033	71
096-VI09	225	10-018-10	15	10-035-01	23	11-012	35	13-011	40	14-034	71
096-VI10	224	10-020	18	10-038	21	11-013	33	13-012	40	14-037	69
10-001	18	10-020-01	18	10-038-01	21	11-015	33	13-013	45	14-038	69
10-001-01	18	10-022	19	10-039	18	11-016	33	13-014	45	14-039	57
10-001-02	18	10-022-01	19	10-039-01	18	11-017	33	13-020	45	14-039	61
10-001-03	18	10-022-02	19	10-039-11	18	11-018	33	13-025	51	14-040	69
10-001-07	18	10-022-03	19	10-039-11	113	11-019	35	13-026	46	14-041	69
10-001-08	18	10-023	19	10-041	18	11-020	35	13-027	47	14-042	61
10-002	17	10-023-01	19	10-041-01	18	11-021	34	13-028	47	14-044	100
10-002-01	17	10-023-02	19	10-043	17	11-022	31	13-029	47	14-045	100
10-003	16	10-023-03	19	10-043-01	17	11-023	33	13-030	47	14-046	58
10-003-01	16	10-024	19	10-043-02	17	12-001	25	13-032	48	14-047	58
10-003-04	16	10-024-01	19	10-043-03	17	12-002	25	13-033	48	14-050	77
10-004	16	10-024-02	19	10-043-13	17	12-003	25	13-035	48	14-051	77
10-004-01	16	10-024-03	19	10-044	15	12-004	25	13-037	45	14-054	57
10-004-02	16	10-025	22	10-047	17	12-005	25	13-038	45	14-057	67
10-004-03	16	10-025-01	22	10-048	17	12-006	25	13-039	45	14-058	67
10-004-04	16	10-025-02	22	10-049	23	12-007	26	13-042	40	14-061	67
10-004-05	16	10-025-03	22	10-049-01	23	12-008	26	13-045	55	14-062	67
10-004-06	16	10-026	19	10-049-02	23	12-009	25	13-046	43	15-001	87
10-005	15	10-026-01	19	10-049-03	23	12-010	26	13-047	58	15-002	87
10-005-01	15	10-026-02	19	10-050	17	12-011	26	13-050	46	15-003	81
10-005-02	15	10-026-03	19	10-050-01	17	12-012	26	13-051	46	15-004	88
10-005-03	15	10-027	19	10-050-02	17	12-013	26	13-052	46	15-005	88
10-005-04	15	10-027-01	19	10-050-03	17	12-018	27	13-053	46	15-007	88
10-005-05	15	10-027-02	19	10-050-13	17	12-019	27	13-054	46	15-010	97
10-005-06	15	10-027-03	19	10-051	15	12-020	27	14-001	62	15-011	97
10-006	15	10-028	17	10-051-01	15	12-021	27	14-002	62	15-012	96
10-006-01	15	10-028-01	17	10-051-02	15	12-023	27	14-003	62	15-015	88
10-006-04	15	10-028-02	17	10-051-03	15	12-024	25	14-004	62	15-017	88
10-007	16	10-028-03	17	10-052	15	12-025	25	14-005	62	15-019	97

15-020	105	17-003	137	17-057	125	18-011	156	18-071	164	20-004-10	147
15-027	106	17-004	137	17-057-02	125	18-012	158	18-072	154	20-004-12	147
15-028	106	17-007	136	17-058	125	18-013	159	18-073	172	20-004-30	147
15-030	102	17-008	136	17-058-02	125	18-014	161	19-001	176	20-004-36	147
15-030	223	17-009	136	17-060	132	18-015	155	19-002	176	20-005	147
15-031	81	17-010	136	17-061	132	18-016	155	19-004	176	20-005-02	147
15-032	81	17-011	136	17-062	132	18-017	153	19-005	176	20-005-03	147
15-033	81	17-012	131	17-064	126	18-018	157	19-006	175	20-005-04	147
15-034	81	17-013	129	17-078	137	18-019	153	19-007	177	20-005-05	147
15-034-10	81	17-014	129	17-079	141	18-020	154	19-008	176	20-005-06	147
15-035	81	17-015	129	17-080	141	18-021	159	19-009	177	20-005-08	147
15-036	81	17-016	133	17-081	141	18-022	158	19-010	179	20-005-10	147
16-010	120	17-017	132	17-082	141	18-023	154	19-011	179	20-005-12	147
16-011	120	17-018	133	17-083	141	18-024	159	19-013	178	20-006	147
16-012	120	17-019	127	17-084	137	18-025	157	19-015	178	20-006-02	147
16-013	120	17-020	127	17-085	125	18-026	160	19-016	178	20-006-03	147
16-014	120	17-021	127	17-086	127	18-027	156	19-017	179	20-006-04	147
16-015	120	17-022	127	17-087	127	18-030	168	19-019	180	20-006-05	147
16-016	120	17-023	127	17-088	127	18-032	169	19-019-10	180	20-006-06	147
16-017	120	17-024	127	17-089	125	18-033	169	19-020	178	20-006-08	147
16-018	110	17-025	126	17-090	125	18-034	169	19-021	178	20-006-10	147
16-019	110	17-026	126	17-091	128	18-035	169	19-022	176	20-006-12	147
16-020	110	17-027	126	17-092	128	18-036	168	20-001	145	20-006-30	147
16-021	110	17-028	126	17-095	132	18-037	168	20-001-03	145	20-007	147
16-022	109	17-029	126	17-096	132	18-038	168	20-001-04	145	20-007-02	147
16-022-02	109	17-030	126	17-097	132	18-039	168	20-001-05	145	20-007-03	147
16-023	109	17-031	126	17-100	134	18-040	158	20-001-06	145	20-007-04	147
16-023-02	109	17-032	126	17-101	134	18-041	160	20-001-08	145	20-007-05	147
16-024	109	17-033	128	17-102	134	18-042	160	20-001-10	145	20-007-06	147
16-024-02	109	17-034	132	17-103	134	18-045	170	20-001-12	145	20-007-08	147
16-025	109	17-035	127	17-104	134	18-046	158	20-002	147	20-007-10	147
16-025-02	109	17-036	127	17-105	67	18-047	158	20-002-03	147	20-008	147
16-026	109	17-037	141	17-106	67	18-048	162	20-002-04	147	20-008-01	147
16-026-02	109	17-038	141	17-110	134	18-049	166	20-002-05	147	20-008-02	147
16-027	109	17-039	141	17-111	134	18-050	166	20-002-06	147	20-008-03	147
16-027-02	109	17-040	141	17-112	134	18-051	171	20-002-08	147	20-008-04	147
16-028	109	17-041	141	17-113	134	18-052	170	20-002-10	147	20-008-05	147
16-028-02	109	17-042	141	17-114	134	18-053	170	20-002-12	147	20-008-06	147
16-029	109	17-043	141	17-115	134	18-054	167	20-003	147	20-008-08	147
16-029-02	109	17-044	141	17-116	134	18-055	171	20-003-03	147	20-008-30	147
16-030	109	17-045	138	17-117	134	18-056	167	20-003-04	147	20-009	147
16-030-02	109	17-046	138	17-118	134	18-057	167	20-003-05	147	20-009-01	147
16-032	110	17-047	138	18-001	154	18-058	153	20-003-06	147	20-009-02	147
16-033	110	17-048	138	18-002	157	18-060	164	20-003-08	147	20-009-03	147
16-034	110	17-049	139	18-003	154	18-061	137	20-003-10	147	20-009-04	147
16-035	110	17-050	139	18-004	155	18-062	137	20-003-12	147	20-009-05	147
16-036	110	17-051	138	18-005	153	18-064	172	20-004	147	20-009-06	147
16-037	110	17-052	138	18-006	156	18-066	165	20-004-03	147	20-009-08	147
16-038	110	17-053	138	18-007	154	18-067	165	20-004-04	147	20-010	147
17-001	137	17-054	138	18-008	157	18-068	165	20-004-05	147	20-010-01	147
17-002	137	17-055	129	18-009	156	18-069	164	20-004-06	147	20-010-02	147
17-003	71	17-	129	18-010	153	18-070	164	20-004-08	147	20-010-03	147

20-010-04	147	23-010	196	23-080	197	25-055	265	25-114	258	28-007	304
20-010-05	147	23-011	203	23-081	199	25-056	264	25-115	258	28-008	304
20-010-06	147	23-012	203	23-082	199	25-057	269	25-116	258	28-009	304
20-010-30	147	23-013	202	23-083	199	25-061	237	25-117	258	28-010	303
20-010-31	147	23-014	202	23-084	193	25-062	237	25-118	260	28-011	303
20-010-32	147	23-015	192	24-001	212	25-063	237	25-119	260	28-012	304
20-010-33	147	23-016	192	24-002	212	25-064	237	25-120	259	28-016	302
20-011	147	23-017	191	24-003	213	25-065	237	25-121	259	28-018	302
20-011-01	147	23-018	191	24-004	213	25-066	237	25-122	259	28-019	302
20-011-02	147	23-019	205	24-005	207	25-069	268	25-123	259	28-020	303
20-011-03	147	23-019-10	205	24-008	209	25-070	236	26-001	223	28-022	302
20-011-04	147	23-020	205	24-009	214	25-071	236	26-002	223	28-024	302
20-011-05	147	23-020-10	205	24-010	208	25-072	236	26-010	223	28-026	303
20-011-06	147	23-021	195	24-017	211	25-073	236	26-011	223	29-005	312
20-012-05	148	23-022	195	24-019	217	25-074	231	26-012	223	29-006	312
20-013	146	23-023	195	25-001	239	25-075	231	26-013	223	29-010	313
21-001	113	23-024	195	25-002	239	25-076	231	26-020	223	29-011	313
21-002	113	23-025	195	25-003	239	25-077	231	27-001	296	29-012	313
21-003	113	23-026	195	25-004	239	25-078	231	27-002	296	29-013	313
21-004	113	23-027	195	25-008	238	25-079	272	27-003	296	29-014	313
21-005	113	23-028	195	25-009	238	25-080	233	27-005	291	29-016	313
21-006	113	23-029	193	25-010	238	25-081	233	27-006	291	29-017	313
21-008	116	23-030	199	25-011	238	25-082	222	27-007	292	29-018	323
21-010	116	23-031	199	25-012	238	25-083	222	27-008	292	29-019	309
21-011	116	23-032	199	25-013	238	25-084	222	27-010	293	29-020	309
21-012	116	23-034	201	25-014	278	25-085	222	27-011	293	29-021	309
21-013	117	23-035	201	25-015	278	25-086	222	27-012	294	29-022	309
21-016	118	23-036	201	25-016	278	25-087	222	27-014	294	29-023	312
21-017	114	23-038	203	25-017	255	25-089	262	27-017	295	29-025	323
21-018	118	23-039	203	25-018	255	25-090	235	27-019	297	29-028	322
21-020	118	23-040	203	25-019	255	25-091	235	27-021	300	29-029	314
21-021	117	23-041	196	25-020	272	25-092	235	27-022	300	29-030	317
21-022	117	23-042	192	25-021	243	25-093	232	27-027	300	29-033	324
21-033	114	23-043	192	25-022	243	25-094	232	27-029	300	29-035	314
21-034	114	23-044	188	25-023	243	25-095	232	27-031	299	29-038	311
21-035	114	23-045	188	25-027	282	25-096	232	27-032	298	29-039	311
22-002	187	23-046	197	25-028	282	25-097	256	27-033	298	29-040	311
22-003	185	23-047	197	25-029	282	25-098	256	27-034	298	29-041	311
22-004	187	23-048	204	25-035	280	25-100	255	27-035	298	29-042	311
22-005	187	23-049	194	25-036	280	25-101	255	27-039	297	29-043	326
22-006	187	23-051	197	25-037	279	25-102	254	27-042	301	29-044	326
22-007	186	23-058	204	25-038	279	25-103	254	27-043	301	29-047	312
22-008	186	23-059	204	25-039	279	25-104	260	27-044	299	29-048	312
22-011	189	23-063	196	25-040	279	25-105	260	27-045	301	29-049	333
22-013	189	23-064	196	25-041	235	25-106	261	27-046	295	29-053	328
22-014	189	23-065	196	25-042	235	25-107	261	27-047	297	29-054	328
22-017	188	23-068	202	25-043	233	25-108	257	27-048	297	29-055	330
22-018	188	23-069	202	25-044	233	25-109	257	27-049	299	29-056	330
22-019	205	23-070	202	25-051	242	25-110	257	27-050	299	29-057	328
23-007	202	23-071	202	25-052	242	25-111	257	28-002	304	29-058	329
23-008	202	23-072	198	25-053	242	25-112	259	28-003	303	29-059	329
23-009	196	23-073	198	25-054	275	25-113	259	28-004	304	29-062	317

29-063	313	29-139	331	31-015	441	32-028	419	34-015	490	40-079	77
29-064	314	29-140	331	31-016	440	32-030	435	34-015-10	490-491	40-081	517
29-065	314	29-141	326	31-017	440	32-031	435	34-024	491	40-083	517
29-068	324	29-142	326	31-018	443	32-033	428	34-025	491	5201-OTT	121
29-069	310	30-007	337	31-020	473	32-034	431	35-001	494	5230-OTT	121
29-070	310	30-009	335	31-021	478	32-035	431	35-002	494	5280-OTT	121
29-072	310	30-010	336	31-021-01	478	32-042	374	35-003	494	5290-OTT	121
29-073	310	30-011	340	31-021-10	478	32-045	423	35-004	495	5415-OTT	121
29-075	310	30-014	348	31-022	476	32-046	423	35-005	495	A010	405
29-077	310	30-015	348	31-023	476	32-047	393	35-006	495	A021	34
29-078	310	30-018	520	31-024	445	32-048	393	35-007	495	A024	35
29-079	310	30-019	360	31-025	464	32-049	430	35-008	495	A025	34
29-080	311	30-020	361	31-026	452	32-050	377	40-003	513	A029	34
29-086	315	30-022	361	31-028	451	32-051	369	40-005	513	A030	31
29-088	309	30-023	358	31-029	450	32-052	369	40-008	510	A034	35
29-089	309	30-024	356	31-030	476	32-053	377	40-009	510	A037	31
29-092	312	30-026	346	31-031	449	32-054	429	40-011	511	A038	32
29-093	515	30-027	346	31-032	465	32-055	369	40-012	511	A048	34
29-097	325	30-030	349	31-033	465	32-056	429	40-013	511	A049	34
29-097	514	30-032	349	31-034	477	32-057	369	40-014	518	A050	35
29-099	327	30-034	347	31-034-10	477	32-058	369	40-015	518	A051	35
29-100	311	30-035	340	31-035	474	32-059	369	40-016	518	A052	32
29-101	322	30-036	341	31-039	467	32-061	385	40-017	518	A053	32
29-102	314	30-038	337	31-040	467	32-063	428	40-018	518	A054	33
29-103	322	30-040	343	31-041	467	32-064	429	40-019	106	A056	34
29-104	322	30-044	349	31-043	474	32-065	433	40-020	106	B002	16
29-105	322	30-047	344	31-044	476	32-067	379	40-021	106	B002-01	16
29-106	313	30-048	345	31-045	475	32-068	379	40-024	519	B004	16
29-108	312	30-050	338	31-046	459	32-069	379	40-027	518	B004-01	16
29-109	328	30-054	342	31-047	479	32-070	419	40-028	518	B004-02	16
29-110	325	30-055	342	31-047-10	479	32-071	390	40-029	518	B004-03	16
29-112	312	30-056	343	31-048	479	32-072	390	40-030	518	B004-04	16
29-115	321	30-057	338	31-048-10	479	32-073	390	40-031	519	B004-05	16
29-119	323	30-058	338	31-049	479	32-075	372	40-032	519	B004-06	16
29-121	309	30-059	338	31-049-10	479	32-076	372	40-033	519	B005	18
29-122	312	30-060	336	32-001	401	32-077	372	40-034	519	B005-01	18
29-123	311	30-061	354	32-002	404	32-078	372	40-034-02	519	B007	23
29-124	311	30-062	351	32-003	411	32-079	372	40-035	522	B007-01	23
29-125	324	30-063	350	32-006	376	32-080	430	40-036	522	B016	18
29-126	77	30-064	353	32-011	420	32-081	404	40-037	507	B016-01	18
29-127	309	30-065	352	32-012	419	32-082	404	40-038	505	B017	19
29-128	329	30-066	350	32-013	420	33-001	499	40-040	519	B017-01	19
29-129	329	31-003	450	32-014	419	33-002	499	40-050	529	B017-02	19
29-130	324	31-004	455	32-015	386	33-003	499	40-051	529	B017-03	19
29-131	309	31-005	455	32-016	422	33-004	499	40-052	529	B019	21
29-132	303	31-006	455	32-017	395	34-001	481	40-053	529	B019-01	21
29-133	332	31-007	447	32-018	400	34-002	481	40-060	529	B021	21
29-134	332	31-008	442	32-019	400	34-003	482	40-061	529	B021-01	21
29-135	332	31-009	443	32-023	388	34-004	485	40-062	529	B021-02	21
29-136	332	31-011	444	32-025	388	34-005	484	40-063	529	B021-03	21
29-137	332	31-012	441	32-026	399	34-014	490	40-065	517	B025	21
29-138	506	31-013	440	32-027	393	34-014-10	490-491	40-070	507	B025-01	21

B025-02	21	D032	331	E100	42	E269	39	E422	43	F085	106
B025-03	21	D033	330	E101	39	E270	44	E428	57	F086	107
B034	22	D034	331	E103	42	E276	51	E430	53	F087	106
B034-01	22	D038	331	E105	42	E277	49	E431	59	F088	107
B034-02	22	D041	332	E106	42	E279	56	E432	53	F089	513
B034-03	22	D041-01	332	E107	57	E280	51	E433	55	F090	106
B035	22	D046	333	E107	61	E282	53	E434	55	F091	107
B035-01	22	D055	333	E108	43	E285	65	E435	43	F092	513
B035-02	22	D058	315	E112	51	E286	65	F001	81	F093	106
B041	22	D060	315	E114	52	E297	56	F002	89	F094	107
B041-01	22	D061	332	E115	50	E308	50	F003	89	F095	106
B041-02	22	D078	317	E117	52	E321	50	F004	88	F096	107
B041-03	22	D082	324	E121	49	E322	50	F005	87	F098	106
B042	21	D086	323	E122	51	E323	54	F006	87	F099	87
B042-01	21	D089	323	E124	41	E324	54	F007	88	F101	100
B042-02	21	D092	322	E125	41	E325	43	F009	89	F102	91
B042-03	21	D094	333	E126	41	E326	54	F010	96	F103	87
B046	21	D126	310	E127	41	E327	54	F016	96	F105	100
B046-01	21	D142	315	E128	41	E328	54	F017	81	F106	91
B046-02	21	D153	314	E129	47	E329	54	F018	84	F109	100
B046-03	21	D166	325	E145	42	E330	54	F019	99	F110	91
B054	22	D171	325	E146	42	E331	54	F024	98	F111	87
B054-01	22	D172	322	E187	49	E332	73	F025	61	F113	100
B055	19	D181	315	E199	40	E333	50	F025	99	F114	91
B055-01	19	D182	324	E204	51	E334	50	F026	94	F115	91
B056	21	D186	324	E205	52	E340	45	F028	96	F118	91
B056-01	21	D189	324	E207	51	E341	43	F029	96	F119	99
B058	16	D195	315	E208	39	E342	45	F030	96	F120	90
B058-01	16	D262	302	E209	52	E348	51	F031	96	F121	90
B061	22	D281	316	E210	51	E351	50	F034	87	F125	98
B061-01	22	D299	341	E211	49	E352	74	F035	100	F125	101
B062	21	D300	327	E214	48	E353	74	F036	100	F1273-08-030	494-495
B062-01	21	D301	301	E232	59	E361	72	F037	100	F128	98
B066	19	E002	46	E236	52	E362	72	F038	100	F128	101
B066-01	19	E014	45	E237	41	E363	66	F043	91	F129	97
B066-02	19	E025	56	E238	39	E364	66	F044	100	F130	61
B066-03	19	E030	56	E239	40	E365	66	F048	97	F130	99
C002	26	E038	50	E240	39	E366	66	F050	88	F131	106
C005	26	E052	57	E241	52	E369	62	F051	99	F132	106
C006	26	E052	61	E246	49	E379	55	F054	87	F133	106
C008	26	E053	48	E248	74	E380	51	F055	104	F135	87
C042	25	E068	47	E249	74	E387	45	F057	107	F136	83
C045	26	E070	47	E250	74	E390	68	F058	107	F137	83
C048	27	E072	41	E251	74	E391	68	F069	98	F138	111
C052	26	E075	47	E255	49	E392	70	F069	101	F138-02	111
C056	26	E077	48	E256	47	E397	68	F070	98	F142	111
D002	330	E078	47	E257	47	E398	68	F070	101	F142-02	111
D013	331	E081	41	E259	63	E415	53	F071	98	F144	83
D017	330	E082	41	E260	63	E415-01	53	F071	101	F147	111
D024	330	E086	51	E263	63	E416	53	F072	98	F147-02	111
D027	330	E088	52	E264	63	E416-01	53	F072	101	F150	96
D029	328	E091	40	E265	52	E418	44	F083	107	F151	97

F152	111	F266	82	F394	103	F507	105	G135	157	G244	35
F152-02	111	F269	86	F396	104	F509	105	G137-F	166	G244	157
F152-10	111	F271	97	F400	104	F510	105	G139	161	G247	158
F156	111	F272	97	F402	75	F511	102	G147	155	G251	127
F156-02	111	F275	93	F403	75	F513	105	G148	156	G253	163
F156-10	111	F276	85	F404	75	F514	83	G151	162	G255	127
F158	92	F277	85	F405	75	F514	263	G151-F	162	G259	171
F162	87	F278	93	F406	75	G003	127	G154	169	G267	158
F163	90	F285	83	F407	75	G003-F	127	G155	162	G272	171
F164	89	F286	81	F408	75	G004	135	G155-F	162	G273	171
F166	105	F289	99	F409	75	G004-F	135	G158-F	153	G274	166
F173	92	F297	96	F416	83	G005	172	G159-F	162	G279	169
F176	98	F298	102	F427	89	G006	164	G162-F	153	G300	136
F176	101	F300	89	F429	99	G008	135	G163	162	G305	136
F178	104	F306	95	F430	76	G008-F	135	G163-F	162	G314	161
F179	98	F307	95	F431	76	G010	164	G167	162	G315	161
F179	101	F309	102	F432	76	G012	135	G167-F	162	G316	130
F183	93	F310	102	F433	94	G012-F	135	G169	127	G317	130
F187	89	F312	92	F434	83	G013	169	G170	127	G318	130
F194	86	F317	105	F437	86	G014-F	164	G171	162	G319	130
F200	85	F318	83	F438	84	G015	127	G171-F	162	G324	130
F201	86	F325	85	F439	84	G015-F	127	G174	170	G327	136
F202	86	F326	85	F440	103	G016	135	G175	132	G328	130
F203	93	F328	109	F441	102	G016-F	135	G176	133	G331	160
F208	86	F329	86	F442	88	G017	170	G178	170	G332	160
F214	89	F330	103	F443	83	G018	164	G179	132	G336	73
F215	89	F337	95	F445	83	G019	127	G180	133	G336	165
F216	89	F342	95	F446	102	G019-F	127	G181	126	G337	172
F228	97	F343	93	F449	98	G020	135	G182	170	G338	172
F229	97	F344	93	F449	101	G020-F	135	G184	133	G342	140
F230	97	F345	93	F451	83	G021	170	G186	170	G343	140
F231	111	F346	93	F457	105	G022	164	G187	132	G344	140
F232	111	F347	95	F458	107	G023	127	G188	133	G345	140
F233	111	F348	95	F459	107	G023-F	127	G189	126	G348	172
F234	86	F349	95	F460	107	G024	135	G190	132	G349	172
F235	86	F351	95	F461	82	G024-F	135	G191	133	G351	133
F236	86	F352	85	F462	83	G026	168	G197	397	G352	167
F237	86	F353	85	F464	109	G027	168	G198	130	G357	163
F242	94	F354	85	F468	111	G028	169	G202	129	G358	163
F245	89	F356	84	F468-02	111	G029	169	G205	154	G362	136
F246	94	F357	84	F469	111	G034	156	G209	162	G365	131
F254	82	F359	84	F470	111	G050	168	G217	141	G366	163
F255	82	F363	93	F471	111	G053	141	G217	170	G367	163
F256	82	F364	103	F478	102	G053	170	G218	154	G369	128
F257	82	F365	103	F479	102	G062	155	G219	141	G370	128
F258	82	F379	104	F481	501	G074	159	G219	170	G371	129
F259	82	F381	90	F488	85	G077	161	G220	141	G372	389
F260	82	F382	90	F489	85	G108	135	G220	170	G373	135
F261	82	F388	83	F490	94	G112	135	G233	140	G375	140
F262	87	F391	103	F492	81	G125	168	G236	161	G376	140
F263	83	F392	81	F498	82	G126	166	G237	159	G377	131
F265	82	F393	94	F504	106	G131	153	G241	171	G378	131

G379	131	G465	170	H441	242	H588	267	H731	286	H837	516
G380	166	G466	141	H453	239	H589	267	H732	247	H838	234
G381	166	G466	170	H454	239	H593	201	H733	247	H839	234
G382	166	G467	131	H455	239	H594	201	H734	248	H840	263
G385	160	G468	131	H458	275	H595	240	H735	248	H841	263
G386	160	G469	131	H459	275	H597	196	H737	216	H842	263
G387	159	G470	141	H464	251	H601	275	H739	283	H849	234
G388	159	G470	170	H465	251	H603	262	H740	283	H850	263
G389	167	G471	131	H467	233	H604	284	H741	283	H851	289
G390	167	G472	162	H468	233	H606	185	H744	244	H852	289
G392	72	H016	191	H471	240	H607	185	H747	193	H853	289
G393	164	H019	191	H472	240	H608	185	H748	193	J001	144
G395	126	H022	191	H473	240	H609	196	H750	211	J001-05	144
G396	126	H033	268	H474	267	H611	200	H753	264	J001-06	144
G397	126	H034	268	H475	267	H612	200	H754	250	J001-08	144
G398	126	H040	269	H476	281	H613	198	H755	250	J001-10	144
G399	130	H041	282	H478	198	H614	198	H758	244	J001-12	144
G400	130	H091	269	H502	240	H615	245	H763	189	J029	148
G401	72	H139	252	H504	246	H616	245	H768	249	J030	148
G401	130	H146	282	H505	246	H617	245	H777	241	J031	148
G402	130	H163	271	H513	246	H619	198	H778	241	J032	148
G403	129	H166	254	H514	246	H620	255	H781	220	J033	148
G404	129	H168	254	H515	246	H621	255	H782	221	J034	148
G405	74	H209	194	H516	244	H623	264	H783	220	J035	148
G405	163	H213	194	H517	244	H626	235	H784	220	J070	148
G408	163	H215	194	H518	244	H627	235	H790	221	J071	148
G411	163	H245	277	H519	271	H630	266	H793	201	J071-02	148
G412	131	H246	277	H520	271	H631	266	H794	219	J071-03	148
G413	138	H301	194	H523	270	H636	273	H795	219	J072	148
G414	139	H307	194	H524	270	H642	192	H796	219	J085	145
G416	138	H312	194	H526	210	H643	264	H798	219	J085-05	145
G418	138	H313	268	H527	210	H647	247	H799	221	J085-06	145
G420	138	H316	268	H528	252	H648	247	H802	217	J094	148
G422	139	H338	194	H531	249	H649	251	H803	217	J099	148
G426	135	H356	215	H532	249	H650	251	H805	286	J100	148
G431	70	H358	216	H535	190	H651	266	H806	286	J107	144
G431	139	H379	248	H548	254	H656	249	H809	288	J107-06	144
G432	70	H381	248	H549	254	H659	268	H810	287	J107-08	144
G445	155	H382	278	H554	245	H660	270	H812	287	J107-10	144
G446	165	H383	278	H555	245	H668	274	H813	287	J107-12	144
G447	160	H386	278	H556	245	H671	285	H814	287	J113	146
G448	161	H402	275	H559	250	H672	274	H815	234	J120	143
G450	130	H404	210	H560	250	H677	286	H818	288	J121	143
G451	160	H414	253	H561	198	H678	284	H819	288	J122	143
G452	158	H416	253	H577	243	H697	269	H820	288	K001	175
G457	167	H417	253	H578	243	H704	339	H827	234	K005	175
G458	167	H431	194	H579	243	H713	276	H828	269	K006	178
G460	171	H436	241	H580	243	H717	244	H829	269	K007	176
G462	139	H437	241	H584	253	H719	281	H830	282	K008	175
G464	141	H438	241	H585	253	H720	236	H831	254	K009	175
G464	170	H439	242	H586	253	H721	236	H832	265	K016	177
G465	141	H440	242	H587	267	H730	285	H836	287	K020	178

K035	177	L060	114	P046	319	Q161	452	R079	367	R189	365
K042	179	L061	114	P050	357	Q162	444	R081	432	R190	371
K044	175	L062	114	P060	326	Q163	442	R082	374	R191	389
K055	178	L065	115	P061	326	Q164	442	R083	409	R192	375
K057	175	L066	117	P062	326	Q168	445	R086	370	R193	365
K066	180	L067	116	P063	326	Q178	502	R087	371	R194	365
K067	180	L068	117	P064	310	Q180	503	R088	370	R195	365
K069	177	L085	118	P065	310	Q182	442	R091	408	R196	365
K070	178	L086	119	P066	326	Q183	451	R093	413	R197	386
K074	179	L087	119	Q001	449	Q186	443	R097	400	R198	395
K077	179	L089	119	Q002	455	Q188	441	R107	391	R199	386
K079	177	L091	117	Q003	455	Q190	439	R110	426	R200	386
K080	179	L092	117	Q004	464	Q193	470	R112	401	R201	395
K081	180	L093	117	Q007	464	Q194	475	R115	397	R202	395
K082	180	L094	117	Q011	464	Q198	472	R117	376	R203	388
K083	180	L095	119	Q017	454	Q199	471	R119	413	R206	368
K084	180	L096	119	Q019	451	Q199	503	R120	398	R207	368
K085	180	L101	119	Q021	454	Q207	502	R121	392	R208	429
K086	180	L111	327	Q025	454	Q208	501	R125	392	R208-20	427
K087	180	L112	116	Q035	449	Q210	501	R131	391	R209	377
K088	175	L113	116	Q036	449	Q219	475	R132	390	R210	377
K089	176	L117	119	Q037	453	Q223	470	R133	426	R211	377
K090	176	L118	119	Q040	463	Q237	456	R134	427	R212	377
K091	176	L119	119	Q046	448	Q238	456	R135	429	R213	379
K092	179	L120	118	Q068	475	Q239	479	R135-20	427	R214	379
K095	179	L121	116	Q070	453	Q239-10	479	R136	419	R215	379
K096	180	L122	114	Q071	453	Q240	471	R137	421	R216	379
K102	177	L123	114	Q074	456	Q243	472	R138	392	R220	433
K103	175	L125	118	Q078	466	Q244	473	R139	392	R221	433
L001	119	L140	115	Q079	466	Q245	416	R145	408	R223	392
L003	116	L141	115	Q080	466	Q246	417	R146	408	R224	430
L007	116	L142	115	Q104	446	Q275	439	R150	400	R225	430
L019	114	L143	115	Q120	458	R024	388	R152	406	R226	372
L020	118	L144	115	Q123	448	R035	388	R155	405	R228	375
L029	118	L147	113	Q124	448	R038	388	R156	371	R232	432
L030	118	L148	115	Q125	462	R039	388	R157	375	R233	431
L036	120	N022	506	Q126	457	R041	391	R158	431	R234	433
L037	120	N046	513	Q131	445	R042	422	R159	378	R235	433
L039	114	N047	513	Q133	446	R043	419	R160	378	R241	385
L040	115	N056	507	Q134	448	R045	421	R161	378	R242	385
L041	113	N059	505	Q138	444	R047	422	R164	368	R243	385
L042	118	N062	505	Q139	447	R053	398	R166	406	R244	387
L043	120	P010	27	Q143	468	R058	428	R167	428	R245	434
L044	114	P014	319	Q144	468	R065	388	R172	375	R247	375
L050	119	P018	321	Q145	446	R069	399	R174	381	R251	413
L052	116	P019	324	Q146	447	R070	405	R175	374	R252	426
L053	119	P020	318	Q147	460	R072	428	R176	373	R253	387
L054	117	P026	316	Q151	477	R074	367	R183	370	R254	432
L055	117	P027	27	Q153	457	R075	367	R184	370	R255	426
L056	117	P042	355	Q155	469	R076	367	R185	367	R256	366
L057	117	P044	320	Q157	453	R077	367	R186	365	R256-03	366
L059	118	P045	320	Q160	461	R078	367	R188	367	R257	415

R258	415	S094	435	Z025	517	Z298	520
R259	367	S095	434	Z027-F	517	Z301	516
R262	366	S096	380	Z031	517	Z302	517
R262-03	366	S097	380	Z044	523	Z303	487
R263	407	S098	530	Z058	489	Z304	488
R264	431	S099	530	Z062	523	Z305	486
R265	427	S100	530	Z066	514	Z306	488
R266	417	S101	531	Z067	514	Z307	487
R267	417	T006	509	Z080	517	Z308	488
R268	376	T007	509	Z096	529	Z309	486
R269	390	T009	511	Z104	517	Z310	488
R270	416	T017	511	Z105	521	Z311	516
R271	375	T021	509	Z111	514	Z312	516
R272	384	T022	509	Z112	514	Z313	516
R273	378	T026	510	Z133	483		
R275	416	T028	510	Z135	483		
R276	394	U011	515	Z152	502		
R277	394	U012	515	Z152	502		
R278	394	U013	515	Z155	519		
R279	394	U014	515	Z162	519		
S012	125	U015	515	Z181	359		
S013	125	V002	327	Z246	529		
S018	531	V007	327	Z252	527		
S022	414	V008	327	Z253	527		
S025	424	V017	328	Z254	528		
S034	396	V024	328	Z255	528		
S040	410	V047	329	Z257	527		
S041	402	V051	329	Z258	528		
S057	412	V056	328	Z259	528		
S058	409	V060	506	Z272	325		
S063	403	V062	333	Z273	325		
S064	373	V066	325	Z274	325		
S070	418	V088	325	Z275	516		
S071	418	V091	325	Z276	516		
S072	530	V094	507	Z277	516		
S074	384	V098	329	Z278	325		
S075	384	V101	505	Z280	163		
S076	384	V104	506	Z280	181		
S080	383	V108	27	Z281	163		
S081	381	V110	27	Z281	181		
S082	382	V114	27	Z282	181		
S083	425	V115	328	Z283	528		
S084	531	V120	325	Z284	528		
S085	530	V121	325	Z285	514		
S086	531	V126	327	Z286	514		
S087	424	V127	327	Z287	514		
S088	530	V128	327	Z288	514		
S089	530	V129	327	Z289	516		
S090	530	V130	327	Z290	516		
S091	530	V131	327	Z291	516		
S092	531	V132	327	Z296	520		
S093	531	X766	529	Z297	520		





FRAMON

FRAMON GROUP

FRAMON S.p.A.

Via Francesco Lana, 31 - 25065 Lumezzane (BS) Italy
tel: (+39) 030 8920977 - fax: (+39) 030 8922544
info@framon.it - www.framon.it